

**2300 AD**



**TRAVELLER**



## CREDITS

### 2300AD ORIGINAL WRITERS AND CONTRIBUTORS

Marc Miller, Loren Wiseman, Frank Chadwick, Lester Smith, Timothy Brown, Gary Thomas, Joe Fugate, John Harshman, William H. Keith, Jr. Deb Zeigler, Bryan Gibson and Steve Venters

### AUTHOR

Colin Dunn

### EDITOR

Charlotte Law

### LAYOUT

Jonathan Goodyer

### INTERIOR ILLUSTRATIONS

Carlos Nunes de Castro Torres, Ian Stead, Steff Worthington, Colin Dunn & Laurent Esmiol

### PROOFREADING

Kate James

### PLAYTESTERS

Benjamin Pew, Gavin Dady, Kory Webb, Andrew Welty, Stuart Machin, Richard Hazlewood, Mark Siefert, Brian McDonald, Ewen Spence

### SPECIAL THANKS

Will Chapman, Mike Totman, Peter Harris, Dustin Friel, Earl Woods, Jeff Pitts, Steve Fitzpatrick, Boris ("kafka47") Cibic, Dan Hebditch, Abraham Gubler, Randy MacDonald, Laurent Esmiol, Steven Alexander, Pete Rogan, Dave Malesevich, Joel Benford, Stephen Herron, Jon Crocker, Constantine Thomas, Randy McDonald, Jonathan Pearson, Michael Brinkhues, Roger Calver, Bill Seney, Jeff Hopper, Kevin LaRoche, Wil Hostman

## CONTENTS

|   |     |
|---|-----|
| <i>Introduction</i>                                 | 2   |
| <i>Background</i>                                   | 5   |
| <i>Core Worlds</i>                                  | 11  |
| <i>Frontier Worlds</i>                              | 37  |
| <i>Foundations, Corporations<br/>And Terrorists</i> | 83  |
| <i>Character Generation</i>                         | 88  |
| <i>Alien Races</i>                                  | 109 |
| <i>Cybernetics And DNA Modification</i>             | 117 |
| <i>Science And Technology</i>                       | 128 |
| <i>Equipment, Weapons And Armour</i>                | 132 |
| <i>Robots And Drones</i>                            | 165 |
| <i>Cortex Hacking</i>                               | 167 |
| <i>Vehicles</i>                                     | 169 |
| <i>Starship Design</i>                              | 190 |
| <i>Starships, Spacecraft And Spacestations</i>      | 218 |
| <i>Spacetravel And Spacecombat</i>                  | 259 |
| <i>Starship Encounters</i>                          | 270 |
| <i>NPCs And Animals</i>                             | 275 |
| <i>2300AD Referee's Guide</i>                       | 286 |
| <i>Near Star List</i>                               | 293 |
| <i>Stutterwarp Efficiency Table</i>                 | 308 |

**DEDICATION:** TO MY WIFE, JULIA. SHE MAKES ALL OF THIS POSSIBLE, AND WORTHWHILE.

2300AD © 2012 Mongoose Publishing. All rights reserved. Reproduction of this work by any means without the written permission of the publisher is expressly forbidden. All significant characters, names, places, items, art and text herein are copyrighted by Mongoose Publishing.

This game product contains no Open Game Content. No portion of this work may be reproduced in any form without written permission. To learn more about the Open Game License, please go to [www.mongoosepublishing.com](http://www.mongoosepublishing.com).

This material is protected under the copyright laws of the United Kingdom and of the United States. This product is a work of fiction. Any similarity to actual people organisations, places or events is purely coincidental.

Printed in the USA.

# INTRODUCTION

Nearly 300 years from now, the calendar is turning over to a new year and a new age. In 2300AD, humanity is attempting to claim the stars as its own. Despite nearly destroying himself in the Twilight War, despite all the wars since, humanity has held on and kept the dream alive. 2300AD is the story of that dream, as humanity, reaches out to the stars.

In 2300AD, humanity has settled 32 inhabitable worlds and has outposts on many more. Human space is divided into three Arms: French, American and Chinese, each named for the dominant nation exploring it. The shape of these Arms is dictated by the limitations inherent in stutterwarp travel, the 7.7 light year range and so travel between the worlds at the centre and the worlds of the edge can take weeks or even months.

At the centre of Human space are the Core Worlds of Earth and Tirane. Tirane is the habitable planet of Alpha Centauri and is a near twin to Earth in climate, gravity and atmosphere. These two worlds together have nearly 90% of the Human population, with 90% of that total residing on Earth. For most people living out in the Frontier, the worlds of the Core are as distant and strange as any alien homeworld.

2300AD games range from interstellar exploration and interstellar war, down to the gritty streets and the mega-cities of the human Core. This is a game about people and their rise to the stars. Aliens are a part of the 2300AD milieu but the focus of the game is on Humans.

2300AD strives to obey the laws of the universe as we know them. The stutterwarp drive, the technology that allows humanity to travel faster than light, is the sole departure from this. Some of the other technologies bend the laws a little but that is from the standpoint of the early 21st century. Three hundred years in the future is a long time. There are no blasters or laser swords in 2300AD, no magic anti-gravity or artificial gravity – just guns and helicopters, spin habitats and spaceplanes. At the same time, though, 2300AD is a game, not a hard-and-fast technical simulation.

## SPACE TRAVEL

For nearly 200 years, humanity has had the freedom of the stars but the hardest part remains getting into space. Stutterwarp drives are used to cross the vast gulf between stars, as it allows FTL (faster-than-light) travel at speeds up to five light years or more per day. For travel within a star system only, so-called

system ships use low-power variants of the standard stutterwarp drive, which still provide very high effective speeds within a system. Otherwise, travel to and from orbit still uses old-fashioned rockets and spaceplanes, although advanced technologies like catapults and orbital elevators are also in use.

## NATIONS AND POLITICS

In 2300AD, national interests continue to dominate human politics, although the influence of transnational corporations (TransNats) and the Foundations is pronounced as well. Many of the nations of today are still recognisable in this future world, including America, Britain, France, Germany, Canada and Australia, along with many others. Foundations are non-government organisations, usually self-funded, that pursue their own agendas, usually in support of science, colonisation, humanitarian or environmental causes, while the TransNats pursue more mundane goals of profit and power.

## COLONIES

Humanity has 47 colonies on 30 worlds, along with scattered outposts, enclaves, mining camps and science stations. The off-world population is a significant fraction of the Earth-bound population and for some nations (France, Britain, Germany, Australia) the off-world population is actually greater. These colonies exist for a number of reasons but one of the most important is national pride – only major nations have colonies. Colonies are also used to provide raw materials for home nation industries and markets for the products of those industries and also serve as a safety valve for the massive population of Earth. For those who can no longer stand the surveillance and control applied to such large populations, the colonies offer a haven, free from the ever-present cameras and constant monitoring. For the Earth-bound nations the colonies provide a pool of individuals who are still useful to the state, although not necessarily suited to being part of it.

## ALIENS

In nearly 200 years of star travel, humanity has encountered five sentient races, with archaeological evidence for at least one more. Humanity has gone to war with one of these races and may yet go to war with another. The first war, versus the Sung, was an absolute victory for the humans, lasting only a

few weeks with minimal casualties on both sides. It remains to be seen whether the current conflict with the Kafers is merely a misunderstanding or the opening phase of something far larger and more destructive.

The table below provides a quick overview of the alien races in 2300AD:

| RACE      | Description  | Notes  |
|-----------|--|--|
| Eber      | Bulky with extremely long arms. Very ceremonial.                             | Destroyed their interstellar civilisation in a war.                      |
| Sung      | Short, reptilian flyers, almost on par with humanity in terms of technology. | Lost a brief war with Humans over the Xiang, lack interstellar travel.   |
| Xiang     | Artistic and very alien spider-like creatures.                               | Enslaved by the Sung until freed by Humans.                              |
| Kaefers   | Big, vaguely humanoid, bug-like in some ways.                                | Recently attacked a human outpost and a distant colony.                  |
| Pentapods | Small, amphibious, vaguely resemble a five-limbed octopus.                   | Masters of biotechnology. Even their starships are organic. Star-faring. |

## STUTTERWARP TECHNOLOGY

The faster-than-light stutterwarp drive is further detailed in Chapter 16 on space travel and combat but a few brief facts follow:

Stutterwarp becomes ineffective at about 0.1G or approximately geosynchronous orbit and is not suitable for interface operations. Attempting to operate within this range risks destroying the ship; although a skilled Engineer can give the crew a small margin of error. The stutterwarp drive requires a specific isotope of tantalum, Ta-180, which is one of the most rare elements in known space but each drive only requires small amounts.

Stutterwarp vessels build up a charge while the drive is operating and moving in unstressed space. The build up of this charge limits the range of stutterwarp vessels to 7.7 light years. Exceeding this range can cause the tantalum coil at the heart of the drive to decay and emit deadly amounts of radiation, usually killing the crew.

Until relatively recently, stutterwarp drives could only be calibrated and brought online in stressed space, that is, regions of space within the 0.001 G limit of a planet or star. The drive calibrator changed that, allowing drives to be brought online in deep space. The Bayern expedition, a joint venture of two Foundations, will use this technology to make its journey to the Pleiades. However, the current generation of these calibrators is far too large for convenient use. In 2299, the second generation drive calibrator entered initial testing. It is hoped that this

technology can be used to build the first commercially-practical stutterwarp tugs, which can get around the 7.7 light year range limitation on interstellar travel. The impact of this technology has yet to be fully felt but it should open up vast areas of space for further exploration. The American Arm in particular stands to benefit greatly.

## ADVENTURES

2300AD is an adventure-orientated game. Players can take on a number of roles, from freelance security experts to hotshot smugglers. While the organisations outlined in Chapter 4: Foundations, Corporations and Terrorists can certainly play a large role, characters do not need to be beholden to them. A small gang of freelance investigators or a group of friends haring off into the wilds on a treasure hunt, is just as viable as a group of troubleshooters contracted by a TransNat who go from world-to-world solving problems and getting into trouble on the side. The emphasis of these adventures is up to each group to decide. 2300AD can be home to high adventure, with lots of gun-fights, desperate chases and swinging over ravines on ropes, as well as more cerebral pursuits such as researching Eber ruins or hacking databases.

## 2300 AD AND MONGOOSE 2300AD

Mongoose 2300AD is an adaptation of the original 2300AD game originally published by Game Designers' Workshop in 1988. Mongoose 2300AD is a sourcebook for use with Mongoose Traveller and requires the Mongoose Traveller Core Rulebook. Supplement 5: Vehicles and Supplement 6: High Guard would also be useful.

As an adaptation, this version of 2300AD departs from the original in several ways, including the addition of DNA modifications and a slightly different background.

## 2300AD AND ORIGINAL TRAVELLER UNIVERSE (OTU)

Despite making use of the Mongoose Traveller rules, 2300AD is not Traveller. It is set in a universe of its own, without any relation to the Official Traveller Universe (OTU). 2300AD is much smaller in scope as well, dealing with a 'mere' 30 or so settled worlds, compared to the 11,000 of the OTU. The levels and types of technology are likewise different, in particular the method of faster-than-light travel, as well as computers and vehicles. There are similarities, however. Both are about people in far-future settings, where star travel is ubiquitous, both focus on the people involved, rather than their equipment and both strive to maintain a realistic worldview, taking into account their histories and technologies.

2300AD is grittier than the OTU, with an emphasis on 'realistic' technology. Thus no anti-gravity or related technologies can be

found, no nuclear dampers or meson guns. The starships also tend to be a lot smaller. Instead of 50,000 dton cruisers so common in the OTU, 2300AD has 900 dton cruisers, with the absolute largest ships being around 10,000 dtons.

## THE NEAR STAR LIST AND STAR MAP

One of the more interesting (and occasionally contentious) parts of the original game was the Near Star List (NSL). This comprehensive list of stars within a 50 light year radius of

Earth was based on the 1969 Gliese stellar survey, which at the time the original game of 2300 AD was published, was the most accurate star list ever produced for a game. Most of the stars are named by their catalogue number, names like DM+4 123.

Since then, science has marched on and we know the positions of stars with greater accuracy, as well as finding dozens of brown dwarfs. These refinements of the star charts and tables would have damaged or destroyed the original setting, so to preserve it, the decision was made to retain the original Near Star List and the map it generated. The Near Star List can be found on page 294.

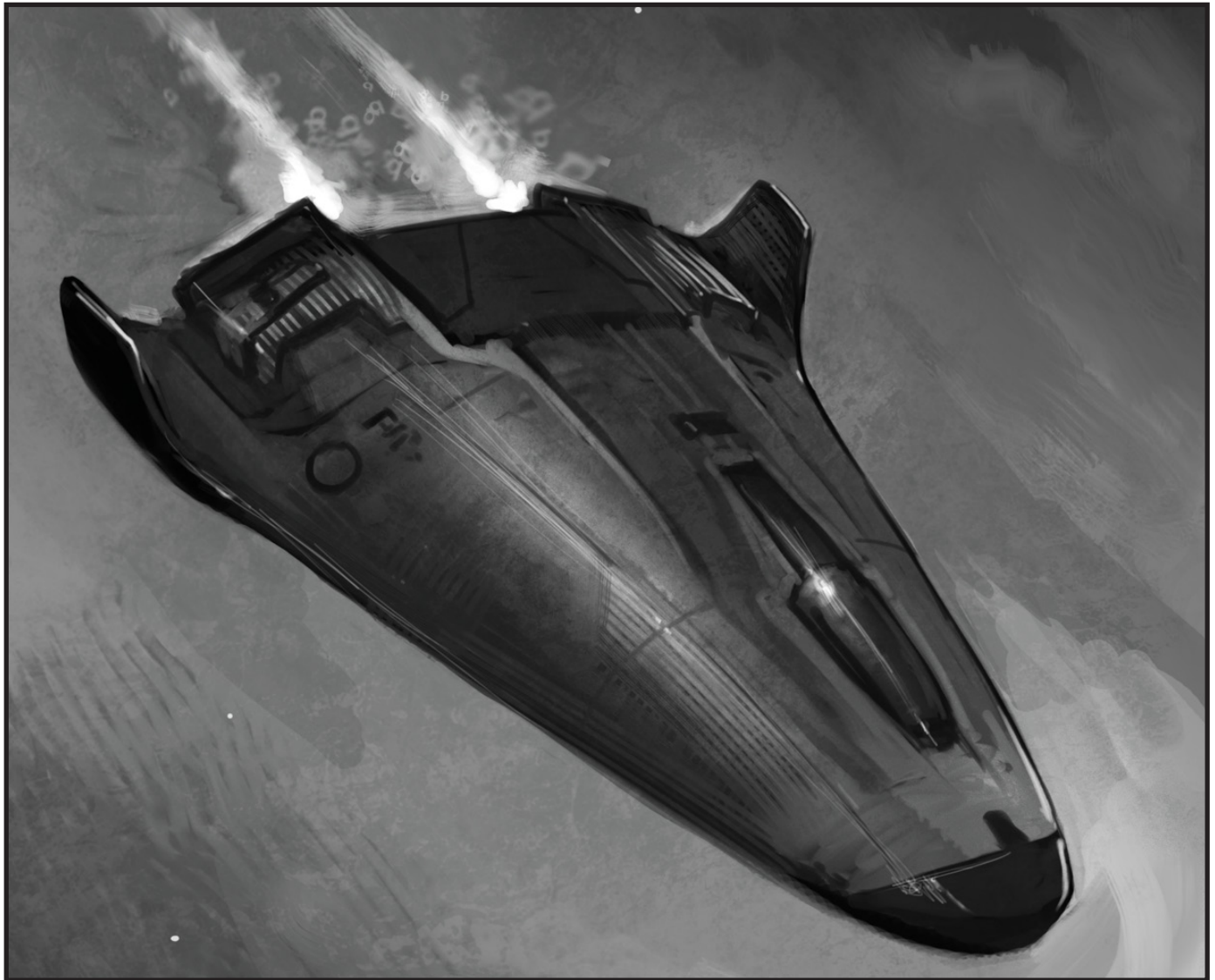

# BACKGROUND

## TWILIGHT

The turbulent decades of the early 21st Century are largely a cypher to 24th Century historians. The near-total loss of data infrastructure, due to a combination of infowar damage and electro-magnetic pulse, resulted in fragmentary and unreliable records from the period. By the end of the second decade, all data was online and paper books and records were practically a lost art. The destruction of the online data turned those lost decades into an age of myth and legend.

Not only is there little known of the prior history but the survivors seemed to have little interest in recording events for posterity. Collectively, this time, stretching from the year 2000 until 2089, is known as Twilight.

The exact events of Twilight are unknown and there are conspiracy theories that posit the idea that the historical record was actively suppressed; although details are unknown, some facts are evident. There was a general, yet limited, nuclear exchange that occurred sometime in the period 2020–2030, with heavy damage occurring in much of Europe, Russia, North America, China and India. Notably, France did manage to stay out of the majority of the conflicts, securing oil supplies in North Africa and effectively sealing its borders.

The causes of the nuclear exchange are a mystery, although there is apocryphal evidence to suggest that it may have been a terrorist incident that triggered the first launches. However, records from this time are effectively non-existent and even the French, who maintained some semblance of records throughout the Twilight period, are silent on the issue of who started the war.

Other events during Twilight included a world-wide influenza epidemic and several other pandemics, especially in the years following the nuclear exchange. There is considerable evidence that at least some of these plagues originated in the bio-weapons labs or one or more of the belligerent nations. Years of mass famines followed due to the destruction of national economies and world-wide shipping. In many ways, the nuclear exchange itself was far from the worst event of Twilight. However, all of the other events flowed naturally from the use of weapons of mass destruction.

In 2079, France returned to what was left of international affairs, ending its long isolation. At this point in time, the United States was

locked in a three-way civil war, Russia was waging a low-key war with Germany, India and China had virtually disintegrated and most nations had undergone some sort of fragmentation into smaller areas that were easier to control without advanced communications.

In 2081, France began launching a constellation of small communications satellites and earth observer satellites. They also regained control of the remaining geosynchronous communications satellites and the Sagan array, the former NASA's deep space telescope. This sudden interest in space was a mystery to the other world governments, what was left of them. While all of this activity was going on overhead, France was making overtures to the other nations, offering access to the communications and weather satellite arrays in exchange for cooperation and renewed trade.

The first manned mission into space since the start of the Twilight period occurred on July 7, 2089. The spacecraft resembled a shuttle of old, although it used air-breathing rockets originally developed by the British, while its payload accelerated out of orbit on a VASIMIR plasma rocket, based on a design rescued from a decrepit warehouse in Mexican-occupied Texas. That payload was a small asteroid interceptor, headed out to divert an Earth-crossing asteroid that had odds of greater than 1 in 20 of hitting Earth, the highest risk ever recorded. The mission succeeded and France used the subsequent goodwill to get the global community talking again and restart international trade.

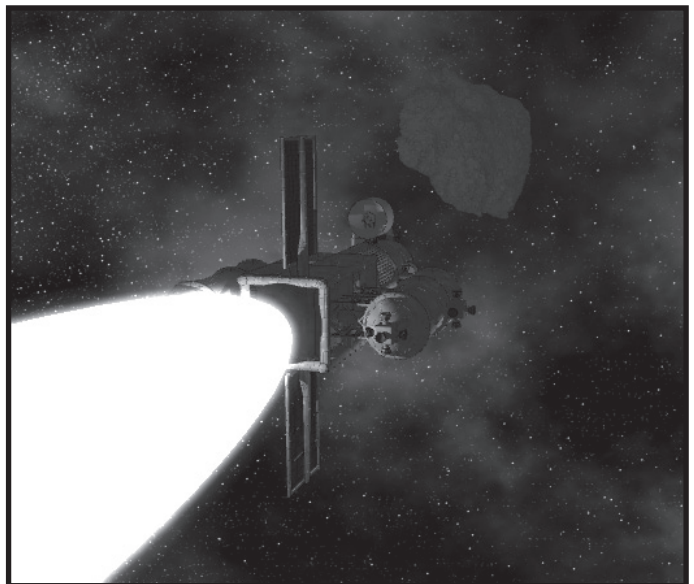

# RECOVERY

With the destruction of the transportation infrastructure during the years of Twilight, the demand for petroleum products plummeted and the nation-states turned towards more readily-available sources of fuel, usually natural gas or, increasingly, hydrogen. At the same time, oil was still necessary for military uses and heavy transportation, what little there was. Towards the close of the Twilight period, France, along with Britain and fragments of other European nations, seized control of the Arab peninsula, deposing what was left of the Saud dynasty. This gave them control of the vast oilfields but bought them decades of terrorist activity until the oilfields and nearby tantalum reserves were exhausted in the mid 2100s.

Into the power vacuum that followed Twilight stepped the only western nation not devastated by the fighting: France, which had withdrawn from the UN and sealed its borders in the early years of Twilight. With its numerous and far flung territories on the African continent and in the Pacific, France re-established a commercial interest in peaceful world trade and calm international relations. French power was projected to resolve disputes among quarreling nations but French national policy was not overtly imperialistic. By 2100, the French were politically involved in virtually every region in the world and French military forces imposed peace in those regions, albeit sometimes a very uneasy one.

After France's stunning asteroid diversion mission in 2089, the world began to return to space in the 2090s with limited surveillance, weather and communication satellite launches and followed in the early 2100s with manned missions. By the end of the first decade of the 2100's, near Earth orbit was cluttered with solar power satellites and orbital factories. France's heavy investment in space for the Twilight Diversion paid big dividends, allowing France to establish a commanding presence in orbit and giving it the ability to sell launch cycles and solar power to any nations that wanted them. As time went on, the conquest of space naturally produced disputes concerning territoriality, access to orbits and the appropriateness of specific targets in conflicts. A continuing international discussion culminated in a series of treaties and agreements collectively known as the Melbourne Accords (first signed at Melbourne, Australia in 2119).

The Melbourne Accords had three major provisions: certain orbits around Earth were demilitarised, power satellites properly operated and certified were classified as civilian targets (rather than military targets) and other worlds (at that time the Moon, Mars, Mercury and the Jovian satellites) were declared open to colonisation by all nations, with limits being placed on such colonisation. The Melbourne Accords bound signatories to its provisions only with respect to other signatories. Many smaller nations signed immediately; holdouts among the major powers included the ESA (France, Bavaria, Britain and Azania, the successor to South Africa) and Canton. Canton signed in 2128 while the ESA did not sign until 2183.

## MAJOR WARS

The wars of the century following Twilight were characterised by struggles for the resources needed to survive and recover. Mexico seized portions of the American south-west, including Texas, parts of New Mexico, Arizona and southern California, for their resources, both mineral and technological. America was too busy fighting a new civil war to intervene. The multi-national, French-led force that occupied Saudi Arabia provided another good example of this sort of war, short and intense, with a clear purpose. Likewise, the war between Canton and Indochina 20 years later was over oil and the ill-fated attempt by Russia to conquer Ukraine in 2095 was for the latter nation's resources. These wars were instrumental in deciding which nations would prosper and which would not, in the coming years.

## THE SECOND AGE OF EXPLORATION

The conquest of space opened a new frontier for the nations of Earth and, naturally, an age of exploration followed. Expeditions to Mars by France and, later, America were launched early in the century, along with expeditions to Mercury conducted by Manchuria. Later expeditions visited the asteroids and the moons of Jupiter but the Second Age of Exploration would have died rather quickly if it had been confined to just the Solar System.

In 2112 the theoretical basis for a practical star drive was established and by 2130, several research establishments were well on their way to demonstrating a prototype. The race for a star drive occupied the technological abilities of the major world powers for the first half of the 22<sup>nd</sup> Century.

During the race to perfect a working star drive, the major nations were gaining considerable expertise in space travel within the Solar System. It was during this time that the first true space habitats were established at the Earth-Moon Lagrange points of L4 and L5. These space habitats were to provide the model for the space-based interstellar outposts to come, while the settlements on the Moon and Mars gave the much-needed experience for building the ground-based outposts and even colonies, that were to follow.

The first working starship was produced by the European Space Agency in 2146; its members (France, Bavaria, Great Britain and Azania) developed the technology and jointly operated the ship and its successors. The first expedition to Alpha Centauri discovered a garden planet, which was promptly claimed for the member nations of the ESA. Within short order, Argentina, China and America built and launched their own starships on expeditions to Alpha Centauri, Barnard's Star and Wolf 359.

### *The Eclipse of France*

Under the French Peace, the nations of the world were able to recover and prosper. Inevitably, some came to resent French domination and as they become more powerful, they competed for power and influence with France. At the same time, the burdens of world leadership proved very costly to

---

### ***The Alpha Centauri War***

The Alpha Centauri War of 2149–2154 was about nothing less than the right of all nations to settle the new worlds being found beyond Earth's solar system. When the ESA discovered the garden world orbiting Alpha Centauri, the member nations immediately claimed it all. Argentina and its allies objected, sending armed ships to the system. The war was a long, drawn-out affair, as each side anxiously awaited instructions from their governments. In the end, the ESA nations capitulated and finally signed the Melbourne accords.

### ***The Tantalum War***

The Tantalum war of 2152 between the emerging nations of Indonesia and Bengal was not just a struggle for the tantalum necessary to construct stutterwarp drives but also a struggle to determine which nation would be able to go to the stars. Indonesia won the war and although the tantalum find was not as rich as they had hoped, they used to build a merchant fleet that even today carries a considerable fraction of all freight moved in Human space.

---

France, already economically stretched in mounting interstellar exploration missions.

By 2150, French power in the world was decaying; other nations were quick to side against France in minor disputes. In the Alpha Centauri War, Argentina and its allies defeated the French-led ESA. This humiliation marked a low point in French prestige and brought about a collapse in the French government, as well as reorientation of government policies. It was the end of the French Peace and the beginning of a new era of global conflict.

### ***Stellar Exploration***

Expeditions over the rest of the century explored to about 20 light years from Earth and settlements were established on about 10 extra-solar planets. Worlds close to Sol sprouted many national colonies; the diversity enabled these colonies to concentrate on specific industries and trade with the others for their needs. But as nations explored farther from Earth, each was able to colonise whole worlds and exploit them without competition from other nations.

Each of these new worlds had different environmental challenges to overcome, lumped together in a malady called Planetary Adaptation Syndrome. Differences in gravity, air pressure, oxygen partial pressure, the partial pressure of other gases and a host of other facts made life on each new world a potential hazard. Eventually most colonists learned to cope but some never could without medical assistance.

The opening of the stars to colonisation moved much of Earth's conflicts beyond the solar system. Conflicts between the major (that is, the starfaring) powers took place on colony and outpost

worlds where they fought for rights to prime territories, access to markets or proper treatment of their own nationals. War on Earth was either an extension of these extra-solar conflicts or minor wars between non starfaring nations.

By 2199, the Second Age of Exploration was drawing to a close. Earth had explored parts of a sphere out to 20 lightyears and established colonies dedicated to exploiting the resources of many virgin worlds.

## **THE SECOND AGE OF COMMERCE**

Exploration breeds commerce; territorial discoveries naturally reveal products that can be marketed. Even with the high cost of interstellar travel, there are always some products, services, metals and information that can still be carried at a profit. With the discovery and settlement of star systems beyond Earth, the 23rd century was an era of trade.

The starfaring nations built fleets to service their colonies. Even a self sufficient colony is useless if it cannot provide feedback, products, information or resources to its parent. Hulls carrying colonists to the stars are most efficient when they carry products and raw materials on their return voyages.

Early in the 23rd Century, France began to re-exert its power in selected regions where its interests were important: Africa, the Pacific and the Mid-East. Avoiding direct confrontation with rivals such as Argentina, Mexico and Manchuria, France was able to rebuild its military strength and reputation over the course of decades. When France fought battles, it won; when it negotiated, it also won. What it could not win, it scrupulously avoided. By 2250, France was almost a superpower.

Developments on Earth, however, did not come to a standstill because of interstellar exploration. International rivalries, population pressures and ideological disputes continued. The nations of Latin America struggled through three Rio Plata Wars as Argentina and Brazil fought for supremacy on their continent. Vietnam, a source of cheap labour early in the century, industrialised to the point that it was a prime plum coveted by both Canton and Indonesia. The Canton-Indonesian War (2264–2268) turned South east Asia into a war zone and made the Indochina Peninsula a restive Cantonese puppet-state.

---

### ***DNA Modification***

Problems with Planetary Adaption Syndrome on many colony worlds led to the development and adoption of DNA modifications, engineered human changes using retroviruses to rebuild human genetics. DNA modifications never became popular in the Core and indeed the media tended to portray DNA modifications as somehow sub-human.

---



## ***The Rio Plata Wars***

Conflict on Earth during this century was dominated by a series of wars between Brazil and Argentina, although the conflict in the Central Asian Republic had far greater consequences. The Rio Plata wars were for territory and see-sawed between the two nations in three wars that collectively spanned over nine years and tensions that spanned over 50. By the end of the Third War, Argentina was able to create the Incan Republic in an attempt to reduce Brazil's power in the northern part of South America. The terms of the final treaty saw Brazil lose the headwaters of the Amazon to the nascent nation, a calculated move designed to humiliate them.

## ***First Contacts***

Given the number of inhabitable worlds, it was accepted as inevitable that humanity would meet other intelligences among the stars. During the second half of the 23rd Century and early years of the 24th, human explorers encountered four intelligent species, two of them spacefaring. Evidence was also found to suggest at least two or more alien races had inhabited the region in the past, with a real, if remote, possibility of their return. With these first contacts came increased cultural diversity into the increasing convergent human culture. Academic investigation of these alien cultures provided new insights into Earth's cultures, both past and present.

## ***The Slaver War***

The Slaver War was the first war fought by humanity against an alien enemy. The Sung, first contacted in 2257, were a race that, much like humanity, was divided up into nations and special-interest groups. They were advanced, with extensive operations throughout their solar system. However, they lacked knowledge of the stutterwarp drive. The Akcheetoon nation was the most powerful of the Sung nation-states and had a colony on the habitable moon of the system's large gas giant. This was primarily a mining colony, using what were at first thought to be local animals for labour. It was not until further examination by a North American Research League undercover team that it was learned that these 'animals' were in fact an intelligent race, the Xiang.

This led to public outcry on Earth and demands that the slaves be freed. Human requests and then demands, upon the Sung to halt their activities on the garden moon were ignored but the Sung remained friendly in all other discourses.

Finally, fleet elements from Canada and Manchuria moved in and were met by Akcheetoon warships, which refused to surrender. Although the Human warships were not travelling at FTL velocities, they were still far enough out of the gas giant's gravity well to be able to run rings around the Sung vessels. The small Human task force was able to destroy the massed alien fleet with no losses. Human infantry units then landed on the moon to isolate and reduce Sung security forces, while diplomatic efforts on the Sung homeworld resulted in the isolation and eventual capitulation of the Akcheetoon nation and eventually the entire world, to human forces.

## ***DNA Revolution***

Continued contact with the Pentapods led to some disturbing insights. Pentapods have so thoroughly embraced genetic engineering as a cornerstone of their technology that they now draw little differentiation between themselves and their machines and there is considerable evidence that the most sophisticated Pentapod devices, like their starships, are engineered from something very like the Pentapod that most people are familiar with.

With this insight, people turned their attention to human DNA modification, one of a pair of technologies that had given humans mastery over the worlds they settled. They saw humanity at the beginning of the road that would lead them to the same place inhabited by the Pentapods, a fluid future where the idea of an individual person had no meaning. This led to many large demonstrations in the Core, where a moratorium on further DNA modification research was announced in 2186. Further work is ongoing on animals and crops but nothing on humans. All terrestrial nations except Vanatau and Iran signed the treaty. Oddly, however, Iran has always stood against human DNA modification.

## ***Economic Stagnation***

Among the colonial powers, the maturation of their colonies led to an economic crisis. The economies of France and many of the Tier 2 nations had been structured along mercantilist lines, where they purchased raw materials from the colonies and in return the colonies purchased finished goods from the home nations. By the middle of the 23rd century, however, many of the colonies on the American and French Arms were effectively independent or conducted their trade with other colonies. This disrupted the balance of trade, as the mother nations still purchased raw materials from the colonies but the colonies for their part had less need of the finished goods the mother nation could provide. This economic slump accounts for the lack of colonial efforts by many of the established Tier 2 nations during this time period. Most of the colonisation programs of the second half of the 23rd Century were by emerging Tier 3 powers like Brazil and Canada.

## ***The Decline of Nationalism***

Easy travel on and off Earth enabled many people to maintain mobile lifestyles without the need for a permanent residence. Some people, such as explorers, starship crew and orbital workers found themselves taxed on the basis of geography but not receiving any real benefit from those taxes. Others found deference and status came with national citizenship rather than merit. Some interest groups created their own non-territorial 'nations' to better protect their interests. Others rejected nationality completely.

At the same time, more people came to philosophically reject nationalism, finding more in common with ethnic, religious, ethical or professional values. The proper national citizenship remained a convenience and the wrong one could be a hindrance but many people had come to feel that there were higher values than mere geographic allegiance.

## ***The Central Asian War***

The Central Asian War (2283–2287) eventually involved France, Bavaria, Russia and Japan arrayed against the imperial armies of Manchuria. Manchuria lost the war but French prestige was broken as they were forced to accept Japanese assistance to drive the Manchurian forces out of the Central Asian Republic. It was the first time since Twilight that so many countries had been involved in one massive conflict and there were persistent fears that one side or the other would utilise nuclear weapons to bring the war to a close. Thankfully, that turned out not to be the case.

## ***German Reunification***

For centuries, the shattered German nation was content to live in the shadow of France. Regions such as Bavaria benefited from a close relationship with France, while others such as Westphalia struggled to chart their own course. The French client-state of Bavaria enjoyed membership in ESA, flew starships under its own national colours and colonised worlds under other suns. The other German states alternately allied with France and Bavaria, with other powers or chose their own paths.

In the 2280s, with growing sentiment for reunification, all the German nations but Bavaria accepted a call from Westphalia to unite. They then mobilised to bring Bavaria into the German nation, as Bavaria by itself was nearly equal in population to the rest of the German states. French objections produced the short War of German Reunification in 2292, in which France was defeated and forced to accept the creation of a new German state. This 'war' was far from a conventional one, with many battles waged in InfoSpace and memetic campaigns raged back and forth in attempts to sway public opinion. Despite the hyperbole, actual military engagements were minimal and only occurred in the final weeks of the war, when German units drove deep into France in what many have dubbed as a 'propaganda raid'. That France was defeated only due to her heavy involvement across the globe and on her colonies is not often mentioned.

## ***The French Empire***

Costly French victory in the Central Asian War in 2287 produced wellgrounded charges of poor support and supply for the army. In 2289, the army staged a coup, which threw out the 12th Republic and established a system of monopolies in vital industries. These monopolies were profitable for the contractors but inefficient sources of supply; as a solution, the junta simply printed money to pay national debts. The result was runaway inflation and tremendous social unrest. When the armed forces could not stop or win the War of German Unification or the Flemish War of Independence, which followed late in 2293, the army was forced to allow free elections, which were manipulated to bring Nicholas Ruffin, a prominent industrialist and free-market advocate, to power. Under his policies, the French economy rebounded dramatically. Careful media handling in the years leading up to the 2298 election produced a French population receptive to the idea of establishing a new empire. Inclusion of the question in a plebiscite attached to the 2298 elections led to the formation of the Third Empire, with Ruffin as the Emperor,

by late 2298. The Chamber of Deputies who appointed Ruffin hoped to use him as a figurehead, a central rallying point for the ideals of French nationalism. Ruffin, however, may well have other ideas.

# TRADITIONAL RIVALRIES

History has created traditional rivalries between certain Human nations.

## ***Franco-German Rivalry***

Bavaria had, until recently, been an ally of France, helping her to restore world order and participating in ESA programs. The War of German Reunification (2292–2293) changed this. The German victory then caused the French to lose prestige and national pride and neither nation is likely to soon forget.

## ***Argentine-British Rivalry***

With disputes dating back hundreds of years, the Argentine and British governments have often been at odds. Their rivalry solidified because of the Alpha Centauri War and the British denouncement of the Inca Republic (although the Republic has since become an embarrassment to its Argentine and Mexican patrons).

## ***Argentine-Brazilian Rivalry***

The Rio Plata Wars were fought for reasons ranging from a need for resources to a quest for economic and political supremacy in South America.

## ***Manchurian-French Rivalry***

When Manchurian intervention into Central Asia erupted in war, the French (as world peacekeepers) became their main adversaries. Many Manchurians living off Earth do not harbour resentment over this but for Terran Manchurians, the French-solicited Japanese intervention was an insult they will not forget.

## ***Manchurian-Japanese Rivalry***

The two major powers of Asia have had a long-running hostility. The current friction between the two nations stems from Japanese action in the Central Asian War, when they intervened to halt the Manchurian advance and eventually turned the war in the favour of France and her allies.

## ***American-Mexican Rivalry***

Mexican control of portions of what was once the American southwest created a strong dislike among Americans for Mexicans. Although it has been 300 years, old dislikes die hard.

## ***Indonesian-Australian Rivalry***

These nations have been skirting the edge of war for decades in the south Pacific, as both have large areas of overlapping influence. Populous Indonesian also looks hungrily to Australia's wide-open spaces.

## ***Vanuatu***

This small island nation is almost universally disliked due to their harbouring of the terrorist group Earth First.

## **TRADITIONAL COOPERATION**

The events of history have also provided some long-lived friendships between nations that have traditionally worked together toward common goals.

### ***American-Australian Cooperation***

Since they were both among the latecomers to the extraterrestrial scene, America and Australia combined their space efforts from the onset. As a result, an entire exploratory arm is virtually dominated by their works, an accomplishment neither nation could or would have aspired to separately.

### ***Canadian-British Cooperation***

Britain and Canada have a long tradition of cooperation and currently enjoy favourable trade relations and close cooperation between their militaries.

### ***Canadian-Manchurian Cooperation***

Canada is one of the few nations on Earth with a positive relationship with Manchuria, due to their shared interests on the Chinese Arm. Canada often acts as an intermediary between Manchuria and the rest of the world.

### ***The ESA***

The member nations of the European Space Agency, France, Great Britain, Bavaria (now Germany) and Azania have a tradition of cooperation in both terrestrial and extraterrestrial matters. Even the split between Germany and France has done little to break this particular bond of friendship at least among each nation's off-world civilian population.



### ***The French Empire***

The French Empire binds together lands and peoples from all over the Earth. From Central Africa to South America to Europe, all subjects of the French Empire feel an elitist camaraderie that binds them together.

# CORE WORLDS

## COREWORLDER

*The tension of the day seemed to drain out of Victor's body as the car left the expressway for the dark road that wound its way through his neighbourhood.*

*The Tube ride from Baltimore to the Maswick junction had been uneventful. It seemed like he had barely time to power up his book and begin reading before the overhead speaker informed him of his stop. Called him by name, in fact.*

*He left the train through a set of softly hissing doors, only to be assaulted by an ad as he stepped out onto the platform.*

*'Hey Vic! Feeling lagged after that long ride from the 'Plex? Check it out! InDex! Hype you up! Pick you up! New from AmeriCo!'*

*The kiosk projecting the ad was three metres away, alongside a couple of vending machines. The InDex machine was new. He was pretty sure that the space next to the Food-Extruder's machine had been vacant that morning.*

*Other ads vied for his attention as he walked to the stairs but he was familiar with them and tuned them out easily. He smiled to himself as he took the steps, two at a time. Not only were the stairs good exercise but the three-story stairwell only had two ad projectors, compared to the escalator's 27. He emerged into the chilled fall air just as a soft rain began to fall.*

*His car was waiting for him, pre-warmed to his personal settings. As the motors hummed to life, the rain began to fall in earnest.*

*'Home,' he told the car, as he buckled himself in.*

*Before the car was out of the parking lot he was already reading his book, content to leave the driving to the TrafCon system.*

*The car beeped an alarm when he was five kilometres from home. Soon the vehicle's system would switch to manual mode and Victor would operate it unassisted for the final approach. TrafCon did not work inside the slow, narrow streets of the village he lived in.*

*He sighed heavily, stowing the book in order to assume the controls, when the car's media system blared to life. Since he had powered it off before leaving the train station, preferring the still*

*silence of the little fuel-cell-powered vehicle for his reading, its unexpected interruption signalled an important announcement.*

*'This is a Local Authorities Bulletin. Please be advised that a possible stress psychotic is thought to be at large near your community. This individual is considered to be very unstable and volatile and should not be approached for any reason.'*

*At this the car's media system projected a rotating 3-D image of a man, maybe in his forties or early fifties. He looked harmless enough but after the system zoomed in to the face, it seemed to Victor that there was something about his eyes, something distant and not quite right.*

*'Of course he doesn't look right,' thought Victor, as the manual control warning beeped again. 'He's Cracked.'*

*The display faded out as Victor assumed control of his car and guided it down the narrow, brightly lit streets of his village. The cameras on the lamp posts watched impassively as he slid past, recording the time and the make and model of the car, while computers along the way queried the car's computer and the small implant in Victor's right bicep.*

*Idly, he noted that his neighbour's house was still vacant. The man had left for Ellis over a month ago, selling the house back to the village housing agency. No one had moved in yet but given the lack of private homes in the area, that situation would not last.*

*Parking his car in front of his house, Victor walked up to the front door and waited briefly for the house computer to recognise both his implant and his biometric signature, before smoothly opening the door for him.*

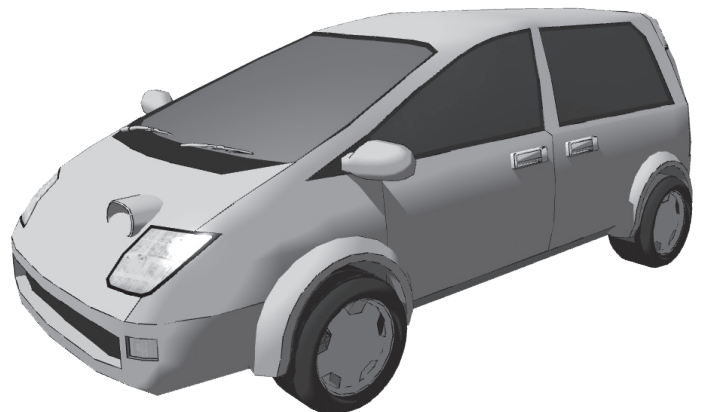

*Once inside, he laid his coat down on the sofa, only to have the cleaning 'bot whisk it away to the front closet. A small smile briefly lit up his face as he imagined the spindly machine scolding him as his mother once had.*

*He hummed softly to himself as he prepared his supper; a small steak, several baby potatoes and a side of steamed vegetables. For dessert, he helped himself to a dollop of real ice cream. As he was about to open the freezer door, its display informed him that he had already exceeded his ideal caloric intake for the day. A brief frown wrinkled his brow as he thumbed the pad for an override. Those three stories of stairs should have earned him at least a little leeway.*

*Victor set the meal down on the table in front of the sofa and the 3V flared to life. As he took the first bite, he set the remote to scan and idly watched the stations scroll past as he ate. Every so often the scan would slow down, as the monitor on the 3V noted his interest but eventually it cycled through all 1,200 channels. By then he had finished his ice cream and was ready to get to work.*

*His hobby chewed almost as much time out of his day as his job but last year he had been agonizingly close to winning the cup. This year, it was going to be his, whatever it took. Leaving his supper dishes for the 'bot, he crossed the room to his workbench, where the 2.1-metre radio-controlled sailboat waited. The media system began to play his most-listened-to bashes, directing the sound to his ears from several hidden audio projectors.*

*He never noticed the noise of the police helicopters approaching, nor the scuffed brown shoes under the curtain.*

*Any security system can be bypassed, if you have the skills.*

## LIFE IN THE CORE

The Core encompasses the worlds of Tirane and Earth but can also be used to describe the lifestyle of any of the more advanced urban areas of long-settled colony worlds like Nibelungen or Beta Canum.

Life in the Core is generally seen by the rest of humanity as extremely hectic, dominated by endless work, endless traffic, endless commuting and an overwhelming feeling of being watched. There is some truth to these stereotypes but there is much more to life at the Core than that.

---

### **World of Tiers**

The nations of Earth are divided into four Tiers, reflecting several factors, primarily economic strength, off-world colonies and global political influence. Tier 1 is at the top, Tier 4 is down at the bottom.

---

Most people in the Core, at least in the better-developed nations, are knowledge workers, who work with their minds rather than their hands, although there are rare exceptions. Automated production has eliminated most factory labour and resource extraction is largely automated or conducted in the extra-solar colonies. Due to this, however, employment rates run very high and a significant portion of governmental budgets is welfare payments for the chronically un- or under-employed. Ironically named *Freelancers*, these individuals eke out the difference between the government cheque mandated for them and their perception of what their lifestyle ought to be.

Life in most of the Core nations luxurious but also carefully controlled. Watchdog systems monitor a citizen's every move, from transponders and GPS locaters in cars to the omnipresent video cameras on every corner. Links and portacomps are likewise monitored, both for content and location. Visitors to the Core nations are often taken aback at the level of scrutiny the average citizen accepts. In return, however, the citizens expect security and convenience. If they get lost, they know they will be found. If their truck breaks down in a remote mountain location, help is already on the way. If a criminal should break into their home, chances are the police know who it is before the door is fully opened and are already on their way.

This does place some constraints on the style of play in the Core nations. It does not mean that characters cannot do anything but that they have to be very careful and thoughtful, of how they do it. Also, not all nations on Earth and Tirane properly fall into this category. Many, like the Central Asian Republic and Iran on Earth and Santa Maria and Tundukubwa on Tirane, do not have these extensive surveillance infrastructures in place. This lack of an infrastructure can be due to a lack of resources, as is the case for the CAR or a disinclination on the part of the government to closely monitor its citizens, as in Tundukubwa. The strictures supporting privacy in the Qu'ran govern the approach taken by the Republic of Iran, where citizens are free from surveillance but foreigners are kept under constant watch.

## CULTURE

Within the Core nations, culture varies greatly. Most nations identify themselves by their cultural heritage and display the language, festivals and other trappings of that heritage proudly. At the same time, the global communications network has also forced a kind of uniformity. Everyone has seen the same shows, listened to the same music, read the same books, despite the language being different. Publishing and media conglomerates, aided by powerful translation software, purvey the same entertainment to everyone. Near real-time translation software provides instant translation for everyone, simply by putting on an earpiece and tapping into the local link network. This cultural homogeneity is one of the driving factors in the colonisation movement, as those who wish to avoid assimilation move out to the stars.

---

## Popular Foods

*The Foot-Long Hard-Boiled Egg:* The signature product of Food-Extruder's, the food popular purveyor of fast-food in human space, is still the extremely popular Foot-Long Hard-Boiled Egg. The corporate motto: 'Slice It!' has become a catch-phrase among urban youth. Lv1.5 for a 30 cm length.

*InDex:* A combination energy drink/soft drink, this AmeriCo product enjoys brisk sales, thanks in part to its extensive advertising campaign aimed at commuters and students. Lv0.25 for 500 ml.

*Curry Loaf:* Another Food-Extruder's product, Curry Loaf is a loaf of bread with one of several different types of curry baked right inside. Choices include vat-grown chicken, beef, goat or vegetable. Lv2 for a 0.5kg serving.

*Montana Dark Chocolate:* Something in the soil of the colony world of Montana adds an extra richness and depth to the flavour of cocoa grown there. Truffles made with Montana chocolate go for more than Lv50/100 grams.

---

The average Coreworlder spends approximately 20–30 hours per week at their job and another 10–20 hours a week at various 'leisure' occupations, like hobbies, sports and so forth. However, there is a certain pressure to excel at these activities, which prevents them from being the release that they should be. Couple that with the ever-present competition for employment and you have a recipe for a great deal of stress. Unemployment rates run at 25% or more for most Tier 2 and Tier 3 nations, a little higher for Tier 4 and a little lower in Tier 1.

Another thing that takes visitors aback on Earth is the level of advertising a person is subjected to as they walk down a street or worse yet, in a shopping mall. Here, the omnipresent surveillance systems are turned towards commerce. Computers read the RFID tags in customers' implants or Links and bombard them with personalised advertising. Using directional sound systems and projected holograms, these ads are often inaudible to those less than a metre away and the imagery is blurred and out of focus. The computers access the potential customer's purchase history and construct a pitch tailored to them. The average store can usually handle up to 20 people at a time, bombarding them with five-second mini-commercials as they walk past. The ads are often targeted at those who can afford the services offered by the store and ignore those who cannot. Visitors find this sensory bombardment bewildering and unnerving but to a resident of the Core Worlds, it's just the way things are and they take no further notice of it than a person of 20<sup>th</sup> Century Earth would take of billboards.

---

## Cracks

Despite the emphasis on shorter work-weeks and a more leisurely life-style, life on the Core Worlds can be very hectic and demanding. There is a strong pressure to succeed and the shorter official work week just means less time to do more work. Add to this the ever-present buzz of the predominantly urban life, the pressures of directed advertising and the constant feeling of being watched and some people just cannot take it.

The official term is 'stress-related psychosis' but the more common term for it is *Crack*. This term is used to describe people who have essentially gone mad with the pressures of modern life. While it is rare for this to manifest itself as violence, that is what makes the news. Other manifestations are more common, including depression, mania and in more extreme cases, catatonia and psychosis.

---

## Environmentalism

A powerful uniting influence on the Core Worlds, in particular on Earth, is a strong sense of environmentalism. Earth came close to destruction during the long years of Twilight, between the nuclear strikes and global climate change and the importance of the environment is central to public thinking on Earth. On Tirane, the inhabitants see their world as an unspoiled gem and aim to keep it that way.

## Surveillance

Another hallmark of Core culture, especially on Earth, everything and everyone, is under the constant watchful eye of the various governments, security agencies and corporations. Cars, phones, computers and even watches all contain GPS locators and often some sort of monitoring hardware or software. Many people elect to get RFID chip implants, which in addition to acting as keys, bank cards and ID, also act as short-range tracking devices. Small drone cameras drift through the cities on blimps, launching recon swarms when a closer look is needed. If a person ever gets into trouble, the authorities will almost always know where they are. Of course, the same holds true for anyone who causes trouble and the constant watching means that the state will have the evidence it needs. Life is highly regulated and controlled. Most people accept it and even come to appreciate it. Society is very safe and secure. Some choose to leave, however and go to find a new life in the off-world colonies. Some are even encouraged to leave, through subtle pressures that can lead all the way to official harassment.

---

## GOTTA GET AWAY

Even in the face of this omnipresent monitoring, there are places on Earth where one can escape the ever-watching eyes. Wilderness areas have little in the way of monitoring, typically limited to portable GPS devices, which are also used as emergency locator beacons. There are still a few wilderness areas on Earth and more on Tirane but these are dwindling over time.

Some older urban areas even contain neighbourhoods that, for one reason or another, are not monitored, where often even the Link network is cut off. Such urban zones, which are extremely rare, are known as *Blights* to the authorities and *Havens* to other, less law-abiding, types. While drones and swarms will still function in these areas, the inhabitants have a habit of shooting them down and taking out swarms with home-made EM weapons.

---

## ROBOTS

The Core abounds with robots, of all shapes and sizes. There are gigantic mining robots, truck size excavating robots, car-sized construction robots, robot workers, robot couriers and even robotic pets. Insect-sized robots and drones wander the land, air and ground of both Core Worlds, while the TrafCon system turns every car into a robot as well and microscopic robots scour people's bloodstreams and help wounds to heal. Most large corporations will have robots as public receptionists and robots as security guards after hours.

---

## OQC

The Orbital Quarantine Command is a quasi-military police force charged with protecting Earth from biological contamination. Any Human-compatible biosystem carries with it the risk of infection. OQC is organised to stop that, with a network of ships and boarding cutters, along with staff on every port-of-call station in Earth orbit. The OQC is supported by all Tier 1, 2 and 3 powers, along with Russia. They have the power to search any vessel, any cargo and deal with any threat.

---

## EARTH/SOL A867978-C N In R1

### X, Y, Z COORDINATES: 0, 0, 0

The centre of human space, Earth still has more people than all the other worlds combined and boasts the best of everything. To many people from the Frontier, Earth's society and culture is every bit as alien as that of the Sung or even the Pentapods.

In addition to Earth itself, the Solar System boasts eight other planets, many of which have some level of human habitation.

None of these other worlds are particularly amenable to life and were settled before the invention of the stutterwarp drive gave humanity the stars.

## THE SOLAR SYSTEM

The return to space a few decades after World War III produced a succession of interplanetary expeditions. The Manchurians established a base on Mercury, the French placed one on Mars; several nations prospected the asteroids. Until the development of stutterwarp, the solar system was the only frontier available in space. The other planets were a haven for scientists and researchers looking for clues on the nature of the universe but of little use to those looking to escape Earth.

When stutterwarp opened up interstellar space, planets of the solar system became second-class locations. It was easier and cheaper to place colonists on garden planets around other stars than to exploit inhospitable planets such as Mars or Mercury. The American settlement on Mars and the Manchurian settlement on Mercury were originally established as colonies but they are now simply commercial mines and bases, with their populations rotating in and out on a regular basis.

Travel between the worlds of the Solar System is generally accomplished with low-power stutterwarp vessels, which require much smaller (and cheaper) drive units than the faster interstellar vessels.

As in most outpost-level facilities, firearms and other weapons are strictly forbidden in any of the planetary bases. The chances of catastrophe are just too high. The Law Level in these installations is always at least 8 and can be higher.

### *Mercury (UWP X30046A-B)*

Manchurian commercial interests maintain a consolidated base of about 10,000 people in the craters at the North Pole of Mercury, sending out expeditions onto the bright face of the slowly turning planet to exploit pools of liquid self-smelting metals. Expeditions into the dark face recover pockets of frozen water and gas that are used for life support and chemical synthesis. Organisations and other nations rent space at the consolidated base for scientific research or prospecting. Despite the sheltered location at the Mercurian poles, these bases are tunnelled several hundred metres into the surrounding rock, primarily for protection from radiation and the occasional solar flare.

### *Venus (UWP X7B0316-8)*

Venus sees little in the way of visitors, aside from the occasional manned lab floating high in this planet's corrosive atmosphere. These balloon labs are usually funded by one of the science-based foundations investigating the runaway greenhouse effect and devising ways to avoid it in the ongoing terraforming efforts of distant worlds. Some have investigated using robots and drones to mine the surface but only a discovery of tantalum would be worth the expense involved and, so far, no evidence

had been found for that particular metal. Russia, Iran and the UAR all maintain balloon labs that work with remote surface probes in the hunt for precious metals.

### ***Mars (UWP C450566-9)***

The American base on Mars is primarily a scientific endeavour, with fewer than 19,000 people, most of them scientists, technicians and their families devoted to developing a greater understanding of desert worlds. It was scheduled to be abandoned in 2265 but the discovery of a small amount of tantalum near Olympus Mons prompted reconsideration and America maintains the base in hopes of finding more.

### ***Belters***

The Belter community in the Sol system has been in decline for the past 50 years, as rich finds grow less frequent and Earth's control grows heavier. Many feel the final straw was the Trilon Corporation building a honeymoon hotel on Vesta. Many Belters have abandoned the Earth system looking for that elusive strike and to get away from the encroachment of Earth's consumer culture.

### ***The Asteroids (UWP D000775-A)***

Most spacefaring nations maintain mining operations in the asteroid belt. Supported by commercial interests offering high rewards for rare finds, the belt attracts rugged individuals interested in getting rich quickly. There is a substantial community of nearly 100,000 Belters in Sol's asteroid belt, despite the rarity of a lucrative strike here. This community is centred on Ceres and maintains an active and dynamic culture. Extensive use is made of large habitat structures to house the populace. The first tests of the Micro-G DNAM were undertaken here, with some protest from many in the Belter community. Long years of living in weightless and very-low gravity environments had rendered most Belters incapable of visiting Earth or any normal-gravity world and even visiting Earth's moon means time in a wheelchair. In that isolation, a new society developed, different

### ***The Tribal Nations***

With Twilight came the collapse of central authority in the United States, Australia, Brazil and Canada. During these years, the native peoples in each country saw an ideal moment and need, to reclaim some of their lost land and achieve a measure of self-reliance. This was accomplished with a minimum of violence, as most people in the affected regions were so grateful to see some measure of control that they did not particularly care where it came from. When central authority renewed contact with the Tribal Nations, it was decided it would be much easier to allow them to keep their new lands and resources and focus on rebuilding with them as partners. Nations within nations, the Tribals have successfully mixed their traditional values and ways of living with the complexities of modern technology and urban life.

from that of Earth or any other settled world. With the Micro-G DNAM, a Belter can travel practically anywhere and the Belter's enforced isolation ended. Many older Belters feel that the DNA modification robbed them of their special society and are bitter about it.

### ***Jupiter***

France maintains a few bases in the Jovian system, including an outpost on Ganymede, a research station on Europa and a system defence facility on the tiny outer moon of Almalthea.

### ***Saturn and Beyond***

Various nations (America, France, Azania, Argentina, Japan and Indonesia) have established temporary bases at Saturn, Neptune and even Pluto.

The Xenon Group, an Indonesian Transnational, has a small research facility at Titan, consisting of a ground station and an orbital facility. They appear to be investigating the possibility of mining Titan's sub-surface hydrocarbons to provide chemical feed stocks but they are in very early stages. NARL has objected to the plan to 'strip mine a pristine satellite that should be held in trust for all mankind'. The group has already formally protested to the Indonesian parliament and the issue is likely to wind up in court.

## **EARTH**

The jewel of the solar system and, despite occasional claims to the contrary, still the most suitable world in known space for Human life.

From the standpoint of the 20th Century, Earth is much cleaner and a little bit warmer. As fossil fuel use has been eliminated for at least 200 years, the cause of the global warming has been attributed to a slight increase in solar output. Sea levels are a little higher as well, either inundating coastal regions or forcing the construction of ever-growing seawalls and dykes to protect cities and farms. Little on Earth has escaped the touch of man.

### ***CULTURE***

Earth seems to be a chaotic jumble of cultures and languages, with 127 nations and over seven billion people. At the same time, a certain set of common values seems to bind most people on Earth, at least those in the 1<sup>st</sup> to 3<sup>rd</sup> Tiers, commonly identified as the space-going nations. Most of these nations are liberal

### ***Things to do on Earth***

Many of Earth's greatest architectural and cultural treasures managed to survive Twilight and live on in such places as the Pyramids in the UAR, Machu Picchu in the Inca Republic, New Orleans in the United States and Stonehenge in Britain. Earth also has the best museums and art galleries, the best live music and probably the most vibrant night-life anywhere.



democracies (with a few notable exceptions), wealthy and prosperous. Most have free-market economies and the average worker makes about Lv15,000 per year. Tier 4 nations tend to have somewhat lower standards of living and are less likely to be part of the global culture that permeates the other nations.

### **LAW LEVEL**

Law Level determines what sort of weapons can be legally carried and how much harassment one can expect from local law enforcement. Law Levels on Earth and Tirane are uniformly high, with private ownership of firearms largely illegal (Law Level 8). Typically only those who can prove a genuine need can own firearms.

## **NATIONS OF EARTH**

### ***Nations and Languages***

| <b>Nation</b> | <b>Language(s)</b> | <b>Nation</b>      | <b>Language(s)</b>      |
|---------------|--------------------|--------------------|-------------------------|
| North America |                    | Europe             |                         |
| America       | English            | Albania            | Albanian                |
| Canada        | English, French    | Austrovenia        | German                  |
| Mexico        | Spanish            | Britain            | English                 |
| Texas         | English, Spanish   | Bulgaria           | Bulgarian               |
| South America |                    | Catalonia          | Catalan                 |
| Argentina     | Spanish            | Croatia            | SerboCroatian           |
| Bolivia       | Spanish            | Czechoslovakia     | Czech                   |
| Brazil        | Portuguese         | Flanders           | Dutch, French, German   |
| Chile         | Spanish            | France             | French                  |
| Inca Republic | Spanish            | Germany            | German                  |
| Paraguay      | Spanish            | Greece             | Greek                   |
| Uruguay       | Spanish            | Hungary            | Hungarian               |
| Venezuela     | Spanish            | Ireland            | English, Gaelic         |
| Africa        |                    | Italy              | Italian                 |
| Angola        | Portuguese         | Latvia             | Latvian                 |
| Azania        | English            | Netherlands        | Dutch                   |
| Biafra        | English            | Poland             | Polish                  |
| Ethiopia      | Amharic            | Portugal           | Portuguese              |
| Kenya         | English            | Romania            | Romanian                |
| Madagascar    | French             | Russia             | Russian                 |
| Malawi        | English            | Scandinavian Union | Scandinavian            |
| Mali          | French             | Serbia             | SerboCroatian           |
| Mozambique    | Portuguese         | Spain              | Spanish                 |
| Nigeria       | English            | Switzerland        | French, German, Italian |
| Somalia       | Somali             | Ukraine            | Ukrainian               |
| Tanzania      | English            | French Empire      |                         |
| Ubangi Shari  | Ubangi Shari       | Algeria            | French                  |
| Zambia        | English            | Burkina Faso       | French                  |
| Zimbabwe      | English            | Cameroon           | French                  |
| North Africa  |                    | Chad               | French                  |

| <b>Nation</b>     | <b>Language(s)</b> | <b>Nation</b>    | <b>Language(s)</b> |
|-------------------|--------------------|------------------|--------------------|
| Berbera           | Arabic             | Djibouti         | French             |
| Eritrea           | French             | French Polynesia | French             |
| Kanuri            | Kanuri             | Gabon            | French             |
| Mauritania        | French             | Guinea Coast     | French             |
| Morocco           | Arabic             | Guyana           | French             |
| Polisaria         | Arabic             | Katanga          | French             |
| Tunisia           | Arabic             | Senegal          | French             |
| UAR               | Arabic             | Zaire            | French             |
| Middle East       |                    | Oceania          |                    |
| Arabia            | Arabic             | Japan            | Japanese           |
| Armenia           | Armenian           | Nauru            | English            |
| Baluchistan       | Farsi              | New Zealand      | English            |
| Iran              | Farsi              | Philippines      | Filipino, English  |
| Iraq              | Arabic             | Australia        |                    |
| Kurdistan         | Kurdish            | Australia        | English            |
| Palestine         | Hebrew, Arabic     | Papua            | English            |
| Syria             | Arabic             | Tasmania         | English            |
| Turkey            | Turkish            | Indian States    |                    |
| Asia              |                    | Afghanistan      | Pashto, Dari       |
| Azerbaijan        | Azerbaijani        | Bengal           | English, Bengali   |
| Burma             | Burmese            | Bhutan           | Dzongkha           |
| Canton            | Cantonese          | Bihar            | English, Hindi     |
| Central Asian Rep | Russian            | Bombay           | English, Marathi   |
| China             | Mandarin           | India            | English, Hindi     |
| Far East Rep      | Russian            | Madras           | English, Tamil     |
| Georgia           | Georgian, Russian  | Mysore           | English, Malayam   |
| Indochina         | French             | Nepal            | Nepali             |
| Indonesia         | Bahasa Indonesian  | Pakistan         | Urdu               |
| Korea             | Korean             | Punjab           | English, Punjabi   |
| Manchuria         | Mandarin           | Rajasthan        | English, Hindi     |
| Mongolia          | Mongolian          | Sri Lanka        | Sinhalese, Tamil   |
| Tibet             | Mandarin           |                  |                    |



## The Universal Nation Profile

Just as worlds have a UWP, nations in 2300AD have a UNP, the Universal Nation Profile. This serves as a shorthand method to display relevant national information. It is very similar in format to the UWP. Like the UWP, the first digit is the area of the nation, the second represents the quality and coverage of the transportation network, while the third represents the quality and coverage of the telecommunications network. The last four digits are identical to the UWP, detailing Population, Government Type, Law Level and Technology Level. The next set represents the nation's Trade Code data. The next two digits, the first represents the multiplier for the Population Code, while the final number is the number of extra-solar colonies the nations possesses.

This is the UNP format. The description of each letter/number follows in the table.

A-BCDEFG-H J K 1 2

### Nation Area

| Code | Area                                   |
|------|--|
| 0    | City State                             |
| 1    | 1–10 km <sup>2</sup>                   |
| 2    | 11–50 km <sup>2</sup>                  |
| 3    | 51–256 km <sup>2</sup>                 |
| 4    | 257–1,280 km <sup>2</sup>              |
| 5    | 1,281–6,400 km <sup>2</sup>            |
| 6    | 6,401–32,000 km <sup>2</sup>           |
| 7    | 32,001–160,000 km <sup>2</sup>         |
| 8    | 160,001–800,000 km <sup>2</sup>        |
| 9    | 800,001–4,000,000 km <sup>2</sup>      |
| A    | 4,000,001–20,000,000 km <sup>2</sup>   |
| B    | 20,000,001–100,000,000 km <sup>2</sup> |

### Transportation Infrastructure

| Code | Type of Transportation Infrastructure                             |
|------|---|
| 0    | No infrastructure. Completely undeveloped.                        |
| 1    | Limited Road access covering 10% of nation/colony.                |
| 2    | Limited Road and Rail access covering 10% of nation/colony.       |
| 3    | Average Road coverage covering 30% of nation/colony.              |
| 4    | Average Road and Rail access covering 30% of nation/colony.       |
| 5    | Good Road coverage covering 60% of nation/colony.                 |
| 6    | Good Road and Rail access covering 60% of nation/colony.          |
| 7    | Excellent Road access covering 80% of nation/colony.              |
| 8    | Excellent Road and Rail access covering 80% of nation/colony.     |
| 9    | As for 8, plus underground tube trains connecting largest cities. |
| A    | As for 8, plus underground tube trains connecting major centres.  |

|   |  |
|---|--|
| A | Interface transport commonly available |
| B | Area of Nation/Colony                  |
| C | Transportation Infrastructure          |
| D | Telecommunications Infrastructure      |
| E | Population Value, as an exponent of 10 |
| F | Government Type                        |
| G | Law Level                              |
| H | Technology Level                       |
| J | Trade Code 1                           |
| K | Trade Code 2                           |
| 1 | Population Code multiplier             |
| 2 | Number of Extra-solar colonies         |

### Telecommunications Infrastructure

| Code | Telecommunications Network  |
|------|---|
| 0    | No networks at all. Personal radios only.                           |
| 1    | Low-speed data and communications access to 10% of nation/colony.   |
| 2    | Low-speed data and communications access to 30% of nation/colony.   |
| 3    | Low-speed data and communications access to 60% of nation/colony.   |
| 4    | Low-speed data and communications access to 100% of nation/colony.  |
| 5    | High-speed data and communications access to 10% of nation/colony.  |
| 6    | High-speed data and communications access to 30% of nation/colony.  |
| 7    | High-speed data and communications access to 60% of nation/colony.  |
| 8    | High-speed data and communications access to 100% of nation/colony. |
| 9    | As for 8, plus augmented reality networks in major cities.          |
| A    | As for 8, with widespread augmented reality networks.               |

The high-speed networks assume 100% coverage by low-speed networks.

A low-speed network is equivalent to modern high-bandwidth internet connections, with speeds in the 10 to 100 Megabit range.

High-speed connections are equivalent to the fastest modern fibre optics speeds, with speeds in the 10 to 100 Gigabit range.

Augmented reality networks are capable of handling the heavy loads and data requirements of augmented reality, with data speeds in the 10 Terabit per second range.

A967A5A8-C Ri In 3 6 would be the UNP for the French Empire, while B8995A9-C Ri In 1 6 would be the code for France itself.

## Interface Capability and Starports

In most versions of *Traveller*, the first digit of the Universal World Profile (UWP) represents starport type. In *2300AD*, the meaning of the first digit has been changed to reflect the type of interface transport publicly available. Each type assumes that all other lower grades of interface travel are available

|   |  |
|---|--|
| A | Beanstalk                                      |
| B | Catapault                                      |
| C | Spaceplane                                     |
| D | Roton  |
| E | Cargo rocket                                   |
| X | No publicly available interface transportation |

These codes also apply to the Universal Nation Profile and the Universal Colony Profile.

## DESCRIPTION OF TERMS

### Tier Data

Each Tier shares many demographic and industrial characteristics, which are detailed at the beginning of each Tier section.

*Life Expectancy:* Years of life expectancy for someone born in that nation.

*Literacy:* Average literacy rate of adult (18+) population.

*College Education:* Average rate of college education for adult (18+) population.

### Space-based Weapons

The Melbourne Accords set Earth orbit aside as a demilitarised zone. However, there are persistent rumours, anecdotes and conspiracy theories that posit orbital defence platforms, artillery platforms and even doomsday weapons.

## TIER 1

France is the only Tier 1 nation – the French Empire includes not just European France but also French holdings throughout the globe.

*Life Expectancy:* 99 years

*Literacy:* 100%

*College Education:* 89%

### France **B8995A9-C Ri In 1 6**

*Major City(s):* Paris Metroplex (15 million), Rhine Metroplex (22 million), Marseilles (7 million)

*Currency:* Livre

*Colonies:* Nous Voila, Kimanjano, Aurore, Tirane, Beowulf, Beta Canum

France managed to mostly keep out of chaos of Twilight and so escaped with comparatively minor damage. While other nations were slowly rebuilding, France used that time to expand

and grow stronger. The Diversion Project bought France wide acclaim in the late 2000's and helped to elevate it to the world's leading power. The history of the 21<sup>st</sup> and 22<sup>nd</sup> Centuries is very much the history of France.

French Empire holdings include territories across the globe but are largely concentrated in Africa and the South Pacific. Imperial African holdings include the nation of Gabon, which is the location of the first Beanstalk built on Earth. Just the Beanstalk alone has provided a great deal of France's current prosperity, as cargos can be sent to and from orbit at vastly cheaper prices than conventional rockets, spaceplanes or even catapaults.

Culturally, France has tried to preserve its reputation for style and elegance, even as the 3-V plays French translations of Mexican soap operas. French wines and French fashions are still the standard by which others are judged, although France is starting to lose out to Freihafen in the wine department.

In 2299, France became an Empire, with Nicholas Ruffin, a noted industrialist, crowned Emperor. The Empire replaced a failing military junta, which had itself replaced a faltering civilian government. While officially Ruffin shares power with the democratically-elected chamber of deputies, in practice he has been rapidly centralising power in his office.

Quality of life is very high for the average citizen of France, in particular European France.

## TIER 2

At Tier 2 we find the largest colonial powers, those with the most colonies and the biggest fleets to defend them. Tier 2 nations have strong economies as well, fed by off-world resources and orbital factories.

Most Tier 2 nations are a little resentful of France and its position as the pre-eminent nation in Human-controlled space. They tend to chafe at being in 'second-place' and constantly struggle to increase their status and prestige.

*Life Expectancy:* 100 years

*Literacy:* 100%

*College Education:* 88%

### America **BA99847-B Ri In 3 5**

*Major City(s):* 'Megalopolis' Atlantic Metroplex (70 million), San Francisco (2.2 million)

*Currency:* American Dollar

*Colonies:* King, Ellis, Avalon, Hermes, Tirane

The United States of America (popularly known as America or the USA) in *2300AD* is slowly coming out of a long isolationist period. The losses of Twilight and the civil war that followed, served to make America a more introspective nation than when it was a super-power. The three-way civil war between the Military Government (MilGov), the remnants of the civilian government

---

## ***New Orleans***

A side effect of the Twilight War was the temporary de-population of the cities on the Mississippi below Baton Rouge. The chaos and dislocation of the war caused the breakdown of the Mississippi's flood control system and the river did what it has been trying to do since the 1920s: change course. The mouth of the Mississippi is now through what used to be known as the Atchafalaya and as the old river below Baton Rouge became sluggish, the surrounding land turned into salt marsh and its cities (primarily New Orleans) became ghost towns due to a lack of fresh water and extensive flooding. With the development of advanced desalination techniques, New Orleans has been reclaimed from the marsh and remains a popular tourist attraction, despite the rise in water levels that require a far more extensive system of dykes and levees than the city had previously.

---

(CivGov) and an extremist militia calling itself New America created chaos and unrest for a long period of time after the end of Twilight. By the time the civil war ended, America was nearly a generation behind the rest of the world in its rebuilding efforts and had lost Texas, along with parts of New Mexico, Arizona and California, to an opportunistic Mexico.

## ***Britain***      ***B899748-C Ri In 8 4***

*Major City(s):* Thames/Birmingham Metroplex (28 million), Leeds (8 million), Edinburgh (4 million)

*Currency:* Pound

*Colonies:* Beowulf, Beta Canum, Crater, Joi

Britain is known officially as the United Kingdom of Great Britain but is commonly referred to as Britain or the UK. This island nation was hit hard by Twilight. After a long recovery period, Britain emerged as a major European power, although overshadowed by France. Income from trade with its interstellar possessions, along with a continued emphasis on scientific research, has ensured that the British economy remains strong and British technological expertise, particularly in aerospace, are still much in demand.

The current Monarch, Queen Margaret II, has ruled for 30 years and likely has many more left to her.

## ***Germany***      ***B899448-C Ri, In 5 7***

*Languages:* German

*Major City(s):* Ruhr Metroplex (23 million), Berlin (7 million), Munchen (6 million)

*Currency:* Taler

*Colonies:* Joi, Dunkelheim, Beta Canum, Adlerhorst, Hochbaden, Neubayern

The events of Twilight saw Germany fragment into several smaller states, kept divided by regional interests and, it is often assumed, French meddling. The nation was divided for nearly 300 years and only became whole again in 2293. Hanover,

---

## ***The British Commonwealth***

Along with the French Empire, the British Commonwealth is the only true international organisation on Earth. The Commonwealth is largely an economic alliance, although there are political and sporting ties as well. The Commonwealth was revived in 2167 to commemorate the Tirane colonies and as an invitation to other nations to join the effort.

|             |           |
|-------------|-----------|
| Britain     | Ireland   |
| Canada      | Australia |
| New Zealand | Nauru     |
| Kenya       | Tanzania  |
| Uganda      | Mysore    |
| Sri Lanka   | Barbados  |
| Jamaica     | Bermuda   |
| Papua       | Tonga     |
| Wellon      |           |

---

seeing an opportunity as France weakened and went through a stage of internal turmoil, opened talks with the other German nations and succeeded in uniting them. Only Bavaria held out, with its strong off-world possessions and close ties with France. With the other German nations behind it, Hanover exerted stronger pressure on the Bavarian government, resulting in a referendum on unification, which barely passed. France tried to intervene and the War of German Reunification resulted. The united Germany won the war but had to wrestle with many serious internal problems, along with the hesitancy of Bavaria's colonies to join the German fold.

## ***Japan***      ***B89A849-C Ri, In 2 3***

*Languages:* Japanese

*Major City(s):* Tokyo Metroplex (41 million), Yokohama (21 million), Osaka (9 million)

*Currency:* Yen

*Colonies:* Beta Hydri, Joi, Tirane

Japan was one of the few countries to survive Twilight with much of its infrastructure intact, despite being politically fragmented. Even more importantly, however, some of its merchant fleet survived. This allowed Japan to dominate trade during the rebuilding stage after the end of the Twilight period and to emerge as one the most powerful economies on the globe.

Although Japan is a multi-party republic it is also a constitutional monarchy and the current Emperor holds more than just symbolic power. That he chooses to use his power so rarely is a testament to the success of Japanese democracy.

*Deep Blue Sea:* Along with Argentina, Japan is one of the nations most heavily involved in ocean utilisation and resource exploitation. From the free-floating fish farms to the sprawling undersea settlement of Kaitel, Japan depends heavily on its oceanic resources. The North American Research League has always voiced its concern over the Japanese efforts and heavily

monitors the surface facilities, like the farms and power plants. There have recently been rumours of trouble at some of the deep-sea sites, however and NARL is putting pressure on the Japanese government to allow closer monitoring.

### **Manchuria** **CA678A9-B 9 7**

*Languages:* Mandarin Chinese

*Major City(s):* Beijing (47 million), Shenyang (25 million), Taiyuan (17 million)

*Currency:* Manchurian Ruble

*Colonies:* Cold Mountain, Syuhlahm, Chengdu, Kwantung, Dukou, Tirane

Manchuria is composed of northern China, including most of the Mandarin-speaking peoples, along with other territories such as Sovereign Tibet. Of all the Tier 2 nations, Manchuria is the closest to achieving Tier 1 status. In fact, some analysts maintain that Manchuria, not France, is the true Tier 1 power.

While not as advanced in some ways as other nations, Manchuria boasts immense industrial capability, fuelled by a large and ever increasing population.

In terms of population, Manchuria is the most populous country on the planet. The nation's aggressive colonisation programs are primarily aimed at the special cultural groups around the country whose populations are still growing. Although colonisation cannot hope to alleviate the population growth, it can siphon off some of the pressure.

The recent Central Asian War against France, Japan and several other European nations has resulted in a Cold War situation between Manchuria and most other Tier 2 and Tier 3 nations, almost all of whom have some sort of relationship with France. The sole exception, based on joint operations in the Chinese Arm, is Canada, which acts as a diplomatic go-between from Manchuria to France and its allies.

## **TIER 3 NATIONS**

Tier 3 nations are the remainder of the colonial powers. They lack the ability to project much in the way of force over interstellar distances and the bulk of their fleets are smaller craft. Their colonial holdings are often more a source of national pride rather than economic benefits. In terms of quality of life, however, they are the equal/near equal of Tier 1 and 2 nations.

All Tier 3 nations have the following characteristics, resources and services:

*Life Expectancy:* 100 years

*Literacy:* 100%

*College Education:* 85%

### **Arabia** **C-76749-A 2 1 Ri**

*Languages:* Arabic

*Major City(s):* Riyadh (2.8 million), Jeddah (2.3 million), Mecca (1.2 million)

*Currency:* Riyal

*Colonies:* Beta Hydri (Dukou)

Arabia was a prime target during Twilight and even after the period ended, French and British troops were able to occupy the nation's oilfields during the chaos following the collapse of the Saudi government. The monarchy that arose in the place of the Saudis was more populist and accepted a French-drafted constitution putting some limits on the absolute powers the Saudis had enjoyed.

As France, Britain and Japan provided security for the nation, the new government was able to take its resources and use them to diversify the economy, building new industries against the time when the oil would run out.

Arabia was able to accomplish this and by the middle of the 23<sup>rd</sup> Century the country was able to place its first extra-solar colony, with support from Japan. Arabia has no intrinsic starlift capability of its own but it does have a program working in that direction.

---

### **Exchange Rates**

As noted elsewhere, all prices are based on the French Livre and it is the standard for all currency exchange. In general, the currency of Tier Two nations is worth about 75% of the Livre, while the currency of Tier 3 nations is worth about 66%. Tier 4 nations typically fare much worse and have currency values of only about 50% of the Livre.

Specific Examples: American Dollar: 78%, German Taler: 74%, British Pound: 74%, Nibelungen Mark: 71%, Japanese Yen: 70%, Manchurian Ruble: 69%, Australian Dollar: 65%, Canadian Dollar: 71%.

---

### **Argentina** **C-88746-C 7 2**

*Languages:* Spanish

*Major City(s):* Buenos Ares (33 million), Córdoba (5.9 million), Rosario (5.5 million)

*Currency:* Peso

*Colonies:* Montana, Tirane

Like most South American nations, Argentina came through Twilight relatively intact, although the collapse of the worldwide economy did strike it hard. Argentina spent the next century building itself into an industrial powerhouse, with the goal of dominating the South American continent. However, Argentina lacked Brazil's immense reserves of manpower and conflict

between the two nations almost always resulted in a draw. Argentina also focused a great deal of energy on resource exploitation in the South Atlantic, which often brought it into conflict with a resurgent Britain.

When the ESA announced plans to monopolise the newly discovered worlds of Alpha Centauri, it was Argentina that disputed the claims of sole ownership. In cooperation with its allies, Argentina built the first interstellar warships to blockade the new world until all nations were allowed to settle the planet.

Since then Argentina has lagged behind other nations in the exploitation of space. It instead chose to concentrate on sea-floor exploration and resource extraction. It has only really been in the past century that Argentina has settled new worlds, all in the Chinese Arm.

### **Australia** **B968748-C 3 4**

*Languages:* English, Aboriginal languages

*Major City(s):* Sydney (3.9 million), Melbourne (3.1 million), Newcentre (2.9 million)

*Currency:* Australian Dollar

*Colonies:* King, Botany Bay, Kingsland

Like most other nations, Australia was badly damaged by Twilight and effectively ceased to exist as a unified nation for almost 40 years. Papua, along with much of the Northern Territory, went its own separate way during those long years of the collapse. After the re-establishment of central government, the nation saw over 100 years of unparalleled growth. Australia became a space-faring nation in the 2140s with the launch of a constellation of solar power satellites. From 2088, with the signing of the Melbourne Accords, Australia was often called upon to be a mediator and arbitrator in international disputes, a role that continues to this day.

### **Azania C-86845-B 1 3**

*Languages:* English, Afrikaans, Swazi, Zulu

*Major Cities:* Johannesburg (21.4 million), Cape Town (11.1 million), Durban (8.9 million)

*Currency:* Rand

*Colonies:* Tirane, Kimanjano

In the aftermath of Twilight, the social structure of South Africa collapsed. By the time the nation had rebuilt itself, whites were definitely second-class citizens. Over the decades and centuries since, however, the nation has worked at true integration and skin colour is largely irrelevant. Azania has the best-developed economy in Africa and now has a long tradition of personal freedom and tolerance. Azania has become a bit of a haven for people seeking relief from the constant surveillance of most nations and is a popular tourist destination. The rebuilt game habitats are the most popular attractions, along with the casinos and cabarets of Johannesburg and Durban.

Azania traded on her reserves of tantalum to become a member of the ESA and has remained a major partner ever since. ESA exploration teams are often at least half Azanian, many occupying planning and leadership roles.

### **Brazil C-67847-B 4 2**

*Languages:* Portuguese

*Major Cities:* Sao Paulo (33.8 million), Rio do Janeiro (22.3 million), Belo Horizonte (7.3 million)

*Currency:* Brazilian Real

*Colonies:* Tirane, Paulo

Like much of South America, Brazil weathered the storm of Twilight better than Europe and North America. Even so, the largest nation on the continent had its problems. Brazil's has always been somewhat isolated due to its Portuguese language and culture and the events of Twilight did nothing to improve that situation. As a result, Brazil and the rest of the continent spent more time than many other nations in the rebuilding process. The series of Rio Plata Wars through the 23<sup>rd</sup> Century did little to endear Brazil in the eyes of its Spanish neighbours, even when they were not the aggressor.

Brazil and Argentina are the foremost nations in South America and there exists a strong rivalry between them at the best of times. Their conflicts are often through proxy nations like Uruguay, Paraguay and the Inca Republic.

Brazil has a sizeable Aboriginal Nation located in the Amazonian heartland, who despite their ancient traditions, also maintain a significant security force, including many mercenaries hired through the auspices of RebCo SAR.

### **Canada C966748-C Ri - 3 1**

*Languages:* English, French, various Native languages

*Major Cities:* Vancouver (3.1 million), Montreal (2.7 million), Toronto (2.2 million)

*Currency:* Canadian Dollar

*Colonies:* Kanata

Canada survived Twilight better than most and was able to put its abundant natural resources to good use. Canada had always enjoyed close military ties with Britain and in the devastation following Twilight was able to provide food and resources to assist in Britain's recovery.

Canadian universities are renowned throughout human space for the quality of their programs and instruction and many are at the forefronts of their fields. Until the research moratorium, Canada was at the forefront of human DNA modification research and still excels in the manipulation of food crops and domestic animals.



## **Canton** **C96687A-A 5 1**

*Languages:* Cantonese

*Major Cities:* Hong Kong (22.1 million), Shanghai (19.2 million), Canton (16.1 million)

*Currency:* Yuan

*Notes:* Although Tier 3 by virtue of its colony, Canton has much lower rates of literacy and college education than is typical: Literacy: 85%, College Education: 33%. Its standard of living is closer to the bottom of Tier 4 than Tier 3.

*Colonies:* Syuhlham

Like all Chinese nations Canton suffered heavily during Twilight and took an extremely long time to recover. Even today its government is partially based on the old warlord structure and is very feudal in scope. Regional governors have almost complete autonomy and are answerable to Canton only if they fall behind in their quotas, whether agricultural or manufactured goods.

Despite its strong manufacturing economy, Canton is barely a Tier 3 nation. The lack of human rights and poor living and working conditions holds this Manchurian rival back. The nation's sole colony is more of an exercise in politics rather than a true source of economic benefit or national pride.

## **Inca Republic** **C954687-9 Ag - 1 2**

*Languages:* Spanish

*Major Cities:* Bogotá (14.1 million), Lima (7.4 million), Quito (4.1 million)

*Currency:* Peso

*Notes:* The Inca Republic is the most backward of the Tier 3 nations and only possesses colonies due to the generosity of Texas and the support of Argentina. Literacy is only 81%, while the rate of college education is a bare 44%. Average life expectancy is only 67 years.

*Colonies:* Heidelshemat, Austin's World

The Inca Republic was created by Argentina, as a buffer to Brazil and consists of the former nations of Chile, Peru and Columbia. Internal turmoil wracks this nation and the areas outside the large cities see little in the way of formal control unless absolutely necessary. Law Level is much lower in the countryside, at only 4.

The nation has rich reserves of minerals and agricultural potential, most of which remain to be exploited.

## **Mexico** **C966849-B 1 2**

*Languages:* Spanish

*Major Cities:* Mexico City (31 million), Los Angeles (21 million), San Salvador (5 million)

*Currency:* Mexican Peso

*Colonies:* Montana, Kwantung

After the Twilight War, Mexico used the temporary collapse of the American government to seize Texas and large parts of New Mexico, Arizona and southern California, along with much of Central America. Despite losing Texas at the end of the 21<sup>st</sup> Century, Mexico managed to retain the other former American territories.

Mexico boasts a couple of extra-solar colonies but colonisation was never a priority for the succession of military-industrial juntas that have ruled the nation for the past several decades. While free elections were finally held this past year, the current military government has held onto an advisory role.

## **Texas** **C898748-B 1 4**

*Languages:* English, Spanish

*Major Cities:* Houston (2.3 million), Dallas (2 million), Galveston (1.9 million)

*Currency:* Texas Dollar

*Colonies:* Austin's World, Kormoran, Beta Hydri, Heidelshemat

Texas was hit hard in Twilight. First the missiles and bombs during the nuclear exchange and then the Mexican invasion. For nearly a century, Texas was a province of Mexico, until increasingly repressive treatment of Texas citizens by the Mexican government led to a revolt. America gave monetary and military support to the Texas uprising. After over a year of hard fighting, Texas was able to gain its independence. Although offered statehood by America, Texans in the end decided to walk their own path and chose independence in a referendum in 2102.

Texas today is very similar in some ways to the Texas of the 20<sup>th</sup> Century. Oil is still the foundation of the economy, as increasingly specialised methods are employed to completely drain each oil reservoir of every last scrap of petroleum. The Law Level in Texas is the same as most other nations on Earth, save in the area of firearms, where the level is much lower (4), which only prohibits light assault and military weapons and even those can be owned with the proper permits.

Texas has three colonies, plus their enclave on Kormoran (which a Texan will insist is a colony). These were done more out of national pride than any clearly stated economic reason. Unfortunately, the country has become increasingly overextended trying to support all four extraterrestrial holdings. Taxes have been raised twice since 2285 and there are rumours that taxes will have to go up again or else the Kormoran enclave will have to be shut down. Neither option is particularly palatable to the Texan citizenry.

## **United Arab Republic (UAR)** **C987848-B 1 1**

*Languages:* Arabic

*Major Cities:* Cairo (10.2 million), Tripoli (4.3 million), Khartoum (899,000)

*Currency:* UAR Pound

---

## **Oil and Plastics**

Although plastics can be synthesised from a variety of sources, the easiest way to make them is from petrochemicals. Earth imports most of its oil from off-world colonies, usually in unrefined form. Orbital refineries break the raw crude down into whatever is desired. Some companies use mobile refineries, where the crude is refined during the transit time, of between one and two months, from the outer worlds to Earth.

---

*Notes:* The UAR lacks any sort of starship construction facilities, military or civilian

*Colonies:* 82 Eridani (Kormoran)

Formed from the old nations of Egypt, Tunisia, Libya and Sudan, the UAR is a major power in Africa, with the third largest developed economy on the continent. The UAR has long lacked the resources for a successful space program but they were successful in a completely different project. Using modern irrigation and weather control techniques, the UAR succeeded in reversing the spread of the Sahara desert and has gone a long way in the struggle to reclaim the desert for agriculture. Their success has been dubbed 'The Miracle of the Sahara' and is one of the primary factors in the current success of the UAR.

The UAR maintains an extra-solar presence on 82 Eridani, the Eber homeworld, although in competition with Texas. There are plans afoot to found a full colony, along the same lines as what Arabia has accomplished on Beta Hydri. Manchuria offered Haifeng but a world that is 99.6% covered by water was just too foreign for the UAR, so they rejected Manchuria's offer. They are currently in negotiations to construct a colony on Austin's World, with support from the Life Foundation.

## **Ukraine C968747-B 4 1**

*Languages:* Ukrainian

*Major Cities:* Kiev (7.1 million), Odessa (4.9 million), Kharkov (2.6 million)

*Currency:* Hyvna

*Colonies:* Aurore

Twilight was hard on Ukraine and the nation suffered heavily, both in the bombings and the famine and plagues that followed. However, freed from domination by Russia, Ukraine was able to restructure itself and start the rebuilding process decades ahead of its neighbours.

Ukraine has always had one of the richest agricultural regions in the world and this agricultural wealth made the nation a close ally of France through the post-Twilight period.

Today, Ukraine is a modern and progressive nation, with a colony on the fringes of Human space. The alien invasion of the

colony in 2298 caused an outpouring of grief in this nation and a mobilisation is underway to send elite military formations to the distant world, to either relieve the colony or exact revenge.

## **TIER 4 NATIONS**

Tier 4 nations have little or no off-world interests and are often typically somewhat backward compared to the spacefaring nations. The biggest exception to this is Iran, which up until now at least, has chosen to not pursue an off-world presence but is a major player in the Middle-east and Asia on Earth. Tier 4 nations are the most independent of the Earth nations and often have truly unique cultures, separate from the other nations. Many Tier 4 nations seem resigned to their seemingly lowly status. For some of them this contentment is starting to give way to a simmering resentment at being dealt out of humanity's most ambitious development, that of extra-solar colonisation.

There are nearly 100 Tier Four states but only a few will be dealt with here.

## **The Indian States C986976-A 1 0**

*Language:* English, Hindi, Malayalam

*Major Cities:* New Delhi (21 million), Mumbai (12.6 million), Islamabad (6.4 million)

*Currency:* Mixed. Mysore Rupiah is the most widely used

During Twilight, this entire region was devastated by war, famine and civil breakdown. The nation of India fragmented along ethnic and cultural lines and the fragmentation persists to the modern day.

Although made up of a number of nations (Afghanistan, Bengal, Bhutan, Bihar, Bombay, India, Madras, Mysore, Nepal, Pakistan, Punjab, Rajasthan and Sri Lanka), the Indian States are often painted with the same brush by the international media. These states have spent the better part of the past century embroiled in low-scale warfare, with alliances forming, breaking and shifting fluidly. In the past decade, however, Mysore has started to form some solid alliances, ones that seem intent on lasting. Should Mysore and its allies extend this loose alliance, patterned in much the same way as the Confederation of Palestine, then experts feel that peace and stability may very well visit this troubled land. Britain has already extended Commonwealth membership to Mysore and its allies.

---

There is apocryphal evidence that Manchuria or Iran is behind at least some of the unrest on the Indian sub-continent. If incontrovertible evidence could be found of this, it could provide the spur to unite the entire region.

---

## **Iran**            **C967747-B 7 0**

*Languages:* Farsi, English

*Major Cities:* Tehran (7.2 million), Mashhad (2.7 million), Tabriz (1.4 million)

*Currency:* Rial

Iran is the wild-card on the world stage. It is a well-developed and prosperous nation, yet has no extra-terrestrial holdings nor any real space presence at all. Iran's primary goal is to ensure that no 'foreign' state gain control over any of Iran's neighbours or in particular over Iran itself. They have been accused of exporting revolution to neighbouring states but their goals are simpler: they desire to be left alone. Iran is a thoroughly modern nation and while largely secular the ayatollahs still have an important, if largely symbolic, role to play in this parliamentary state.

Sharia law still forms the basis of their legal system but it has undergone many reforms and women have enjoyed equal rights with men for nearly 200 years.

---

### **God of War**

Iran is quietly preparing a space program, concentrating on worlds of the solar system and recently launched an expedition to Mars using a low-power stutterwarp vessel built in Iran and assembled in orbit. The small amounts of tantalum required came from internal Iranian sources, though they are known to not have much. The expedition is fitted out with a large number of mining and survey equipment, landers and over 50 crew members.

---

## **Russia**            **BB68889-B 2 0**

*Languages:* Russian

*Major Cities:* Moscow Metroplex (17.2 million), St. Petersburg (9.5 million), Gorkiy (7.1 million)

*Currency:* Russian Ruble

Russia was likely the most seriously damaged of all nations during Twilight and had only barely managed to start the rebuilding process by the beginning of the 22<sup>nd</sup> Century. Modern Russia is much reduced in size from its heyday prior to Twilight but it is still larger than all other nations on Earth, with abundant resources. The return to a single-party state in the tumultuous post-Twilight years has continued to this day.

Russia lacks easily accessible tantalum resources to be a colonising power and seems to have its hands full with the ongoing development of their terrestrial holdings. Russia does seem intent on playing a role and as a consequence is the second-largest contributor to the OQC after France. Many Russian vessels are purpose-built for the OQC role and their ships are rotated in more often than those of other nations, who regard the OQC fleet as yet another tedious responsibility.

Russia is well-known for the quality of its computer programmers, even if their hardware is imported from the west. Unfortunately, they are best known for hacking, viral and datawar software, although three of the five most popular 3V games in the past year have also come out of Russia.

Russia has long chafed at its Tier 4 status, arguing that its OQC contributions alone should elevate it to at least Tier 3 status.

## **Confederation of Palestine**    **X788749-B 2 0**

*Languages:* English, Hebrew, Arabic

*Major Cities:* Amman (3.2 million), Beirut (3.1 million), Jerusalem (1.7 million)

*Currency:* Sheqel

In the wake of Twilight, Israel and the surrounding nations found that they had to band together in order to survive. Over time, they found much in common and the Confederation came into being.

The Confederation of Palestine is formed from the nations of Israel, Palestine, Jordan and Lebanon. The government structure is unique, although the Indian States seem to be moving towards a similar model. The four nations share a common physical territory but each citizen belongs to one of the four nationalities and lives by that nation's laws. There is no restriction on where they live or what they can do, however.

Palestine has no colonies but the Knesset is discussing the possibility of putting in a colony at Haifeng or possibly Avalon. Both worlds are largely covered by water and would be a culture shock to the natives of this dry nation. They currently have small observer teams on both worlds and are expected to announce a decision in the next decade.

## **Flanders**            **X699649-B 8 0**

*Languages:* Dutch, German, French

*Major City:* Brussels (3.1 million)

*Currency:* Florin

Flanders is the newest nation on Earth at just seven years old. It came into being during the closing days of the War of German Reunification, when a popular uprising led to the expulsion of the French government officials and the creation of a new Flemish nation. The new nation of Germany instantly recognised Flanders' legitimacy and forced France's hand into doing the same.

One of this nation's primary goals is the upgrade of the international airport at Brussels to allow spaceplane traffic, so that Flemish orbital traffic does not have to go through the Netherlands or Germany. At the current time, using French spaceports it out of the question.

## **Indonesia**            **C969888-C 3 0**

*Languages:* Bahasa Indonesian, Malay

*Major Cities:* Jakarta (23.1 million), Surabaya (6.1 million)

*Currency:* Indonesian Rupiah

Indonesia, like all manufacturing nations, was hit hard by Twilight and the resultant collapse of the world's economy. The recovery process was stalled for a long time and when it finally came it was slow. Indonesia tried to speed up the process by attempting to seize Indochina in the late 21<sup>st</sup> Century but found itself stymied by France, although Indonesia was able to take and hold Malaysia. This earned the nation British enmity above even the French, as Malaysia was a Commonwealth nation.

Further imperialist actions served Indonesia well and garnered it the Andaman islands, along with their tantalum ores. This gave Indonesia access to the stars. Even so, Indonesia never established a national extra-solar colony. They built ships, although largely trade vessels and made a reputation for fast, effective shipping and passenger service.

### **Ireland E788647-A 5 0**

*Languages:* English, Gaelic

*Major Cities:* Dublin (810,000), Belfast (790,000), Londonderry (122,000)

*Currency:* Irish Pound

It took the ravages of Twilight to achieve a union between Northern Ireland and the Republic. The need for survival in the wake of a nuclear war and world economic breakdown pushed the two sides to unite.

Now, three centuries later, Ireland is a quietly prosperous nation. Irish citizens seeking a change typically emigrate to a British-controlled colony, as ties between the two nations are strong now that the Northern Ireland question is resolved.

### **Central Asian Republic E944889-9 2 0**

*Languages:* Russian, Tajik, Uzbek, Kazak (all official)

*Major Cities:* Tashkent (17.5 million), Almaty (12.3 million), Dushanbe (9.2 million)

*Currency:* Ruble

The Central Asian Republic is a loosely-knit confederation of five nations that suddenly found themselves independent of Russian influence during Twilight. The five countries, Kazakhstan, Turkmenistan, Tajikistan, Uzbekistan and Kyrgyzstan, banded together against what they feared would be renewed Russian expansionism once that nation had recovered from Twilight. That took generations and in the interim these nations developed a close relationship, eventually becoming a federated republic, modelled, ironically, on the old USSR. That all changed in the 2270s, when Russia began to exert pressure on Kazakhstan in particular to return to the Russian fold. This came to a head in 2282, when, after what is now widely believed to have been a manufactured incident, Russian troops crossed into Kazakhstan to protect Russian citizens. This quickly spiralled out of control and the largest-scale war on Earth since Twilight came to pass. Manchuria moved to support the CAR and Russia called on its ally, France.

The Central Asian War devastated the CAR's economy and led to the coup that replaced the old federal government with a new one, centring on a cabal of generals and financiers.

Now, the CAR and its limited space program are focused on exploration of the solar system in the hopes of finding deposits of tantalum and their ticket to the stars and obtaining the resources to rebuild the war-ravaged nation. One of the main sources of income for the CAR is the ability to launch cargo rockets, which it markets aggressively to other nations lacking spacelift capability.

### **Imperial France A846867-B 2 0**

*Languages:* French, local languages

*Major Cities:* Libreville (22 million), Kinshasa (4.2 million), Algiers (2.7 million)

*Currency:* French Livre

The Imperial French nations do not fit into any category. By themselves, they are clearly Tier 4 nations. However, due to their association with France, they have the resources of a Tier 1 nation to draw upon as well. Most of the Imperial nations are in sub-Saharan Africa, save for a few in the Polynesian Islands. They are all considered departments of France and all have representation in the Chamber of Deputies, the lower legislative branch of the French government.

Gabon, in particular attracts a great deal of international attention, due both to the Beanstalk and the celebrated corruption of the city that rests at the Beanstalk's roots, Libreville.

---

*Imperial French Holdings on Earth:* Algeria, Burkina Faso, Cameroon, Chad, Djibouti, French Polynesia, Gabon, Guinea Coast, Guyana, Katanga, Senegal, Zaire.

---

### **Europe C899879-C 4 0**

*Languages:* Spanish, Italian, Greek, German

*Major Cities:* Madrid (5.1 million), Athens (4.2 million), Rome (3.5 million)

*Currency:* Various

Europe is something of an anomaly. Most of the nations are Tier 4 and dominated by either France or Germany, yet they have lifestyles more in keeping with that enjoyed by Tier 3 or even Tier 2 nations. Europe is wealthy and these nations maintain their wealth largely by not getting involved in colonisation endeavours. However, this cuts them off from the resources that off-world colonies can make available and so they are trapped. Most are not willing to accept the temporary drop in their standard of living that would be required to settle another world but by not doing so, they are unable to advance that standard of living and are actually facing a slow decline as resources get harder to find and

more expensive to purchase. A few countries have participated in joint-venture colonies, the most notable of which was the Bavarian colony of Garten, now Freihafen, on Tirane.

**Nations of Europe:** These nations comprise the rest of Europe and have not been detailed: Albania, Austrovenia, Bulgaria, Catalonia, Croatia, Czechoslovakia, Greece, Hungary, Italy, Latvia, Netherlands, Poland, Portugal, Romania, Serbia, Spain and Switzerland.

### **South America C966877-A 3 0**

**Languages:** Principally Spanish

**Major City(s):** Caracas (7.1 million), La Paz (5.1 million), Montevideo (3.2 million)

**Currency:** Bolivian Mark, Venzeuelan Peso, Paraguay Dollar, Uruguyan Peso

Aside from the three larger nations (Brazil, Argentina and the Inca Republic), South America is composed solely of Tier 4 nations. The damage caused to many of these nations by the succession of Rio Plata wars is part of the reason for their status. Their economies are still primarily agricultural and have not advanced to the point where they can consider investing in space and colonisation. Venezuela, the richest of these nations, lacks the tantalum resources needed for interstellar settlement and have only been able to purchase limited amounts to construct a small fleet of three vessels. These few vessels are involved in prospecting and mineral surveys in the solar system, looking for larger deposits of tantalum.

**South America:** Aside from the Big Three, South America consists of Bolivia, Chile, Paraguay, Uruguay and Venezuela.

### **Asia**

**Languages:** Chinese, Malay, Vietnamese, Korean, others

**Major City(s):** Rangoon (11 million), Hanoi (6.1 million), Tbilisi (3.1 million)

**Currency:** various

Outside of Manchuria and Japan, most of Asia is solidly Tier 4, with lifestyles that reflect this. Even Canton, technically a Tier 3 country by virtue of its sole colony, really has a standard of living more reflective of Tier 4. Most Asian nations lack the resources to colonise other worlds, whether economic, technological or tantalum resources. In 2300 no one is actually starving but the nations of Asia typically make do with much less than those on the other continents. Lacking access to orbital industry, the nations of Asia must deal with more pollutants than Europe or North America, although conditions are still a far cry from the smog-laden days of the 20th Century. Korea is a virtual satellite of Manchuria and is a centre of advanced manufacturing.

**Asia:** The following countries cover the remainder of the Asian nations: Azerbaijan, China, Far Eastern Republic, Georgia, Indochina, Korea, Mongolia, Myanmar and Thailand.

### **Africa C976977-A 1 0**

**Population:** 1.1 billion

**Life Expectancy:** 98 years

**Major Cities:** Addis Ababa (9.2 million), Maputo (5.9 million), Freetown (4.4 million)

**Currency:** various

Africa revolves around four major centres of influence and most of the nations are dominated by these. Azania and its clients make up the largest power bloc on the continent and control the southern portion. Centrally, Nigeria vies with Imperial France for influence and control, while in northern Africa the UAR and France dominate the local nations. Life in Africa outside of the UAR, Nigeria and Azania is still fairly poor, with the economies concentrating on agriculture and mining. Nigeria and Azania provide the bulk of foreign investment in these nations but it is not enough to give them a sound foundation for industrialisation. Again, no one is really starving in 2300, as most of these nations are self-sufficient, at least in food production. They are not as well fed as most other nations, however.

**Africa:** The other African nations are Angola, Berbera, Biafra, Eritrea, Ethiopia, Kanuri, Kenya, Madagascar, Malawi, Mali, Mauritania, Morocco, Mozambique, Polisaria, Somalia, Tanzania, Tunisia, Ubangi Shari, Zambia and Zimbabwe.

### **Middle East X87687A-A**

**Languages:** Arabic, Turkish, Kurdish, others

**Major Cities:** Ankara (4.6 million), Baghdad (4.2 million), Damascus (2.3 million),

**Currency:** various

The Middle East suffered through a great deal of turmoil as a result of the Twilight period and did not start to recover until well after most other nations. By 2300, many of these nations are fairly prosperous through the continued sale of their dwindling reserves of petroleum. Most are in the process of diversifying their economies, with nations like Turkey and Syria now producing high-end consumer electronics but at the moment most of these nations are still resource-dependent.

**Other nations of the Middle-East:** Armenia, Baluchistan, Iraq, Kurdistan, Syria and Turkey.

## **Nigeria B965847-B 1 0**

*Languages:* English

*Major Cities:* Lagos (10 million), Abuja (7.3 million), Ibadan (3.6 million)

*Currency:* Naira

Africa survived the nuclear exchange during the Twilight years but was devastated by the loss of international trade and commerce. When the African nations emerged from the chaos, they had become largely self-sufficient and have managed to put colonialism behind them and build something new. Nigeria was at the forefront of that drive. Nigeria now boasts the second most-developed economy in Africa, after Azania.

Although Nigeria has long been a space-faring nation, they had never established a full colony of their own. They contributed to several, however and Nigerian trade ships are quite common but they never made that leap to a full colony. They are currently in negotiations with America about establishing a colony on the newly-discovered world of Avalon. Nigerian scout teams are already on the planet and a large mobile survey base is due to be soft-landed within the next six or eight months.

Nigeria's constitution prohibits the establishment of a standing military force and the nation relies on the police for all internal matters and international goodwill for external issues.

## **Oceana C668877-9 1 0**

*Languages:* English, French, Pilipino, others

*Major Cities:* Manilla (9.7 million), Auckland (1.1 million), Darwin (800,000)

*Currency:* various

Throughout the oceans of the world are small island nations, the bulk of which are in the South Pacific, although there are some in the Indian Ocean and the Caribbean Sea. Of these small nations, New Zealand stands out as the most developed, while the Philippines, a semi-autonomous Japanese client-state, are the most populous. Most of these nations weathered Twilight fairly well, as they were not targets and were largely self-sufficient. Any of them that relied on international trade were effectively destroyed in the aftermath, however. In 2300, most of these nations live quietly, perhaps as tourist destinations, although most are simply subsistence cultures. These nations are near the bottom of Tier 4, yet quality of life is usually rated high.

---

*Nations of Oceana:* Cuba, Bermuda, Nauru, New Zealand, Papua, Philippines, Polynesia, Tonga and Vanuatu.

---

## **Scandinavian Union C96874A-B 5 0**

*Languages:* Danish, Finnish, Icelandic, Norwegian, Swedish

*Major Cities:* Oslo Metroplex (13.2 million), Stockholm (9.3 million), Helsinki (2.8 million), Copenhagen (5.4 million)

*Currency:* Krona

The Scandinavian Union is a confederation of five nations: Sweden, Denmark, Norway, Iceland and Finland. Commonalities of experience and climate unite these nations as much as a shared language or culture.

The Scandinavian nations were heavily involved in the fighting that occurred during Twilight, with Norway and Denmark receiving the worst damage. Their recovery phase was quite lengthy.

## **SEA FLOOR DEVELOPMENT**

Japan is the nation most heavily involved in undersea development, with several small cities entirely under water and a couple of them quite deep. These cities usually consist of a series of linked modules and domes, in many ways similar to the architecture of the lunar settlements. Subs flit around these undersea cities, from small utility boats to the behemoth transport subs. Dolphins are a common sight at many of these cities as well, as there are several places for them to catch a breath. These cities are the centre of sea floor mining and surface aquaculture efforts and are also popular tourist destinations.

## **Kaitel X0AA54A-C 2 0**

Kaitel is the largest of the underwater cities, settled primarily by Japan. It exists as a semi-autonomous entity on the bottom of the Pacific Ocean, in the centre of vast sea floor mining field, fish farms and other aquatic industries.

Supercavitating drives are not permitted to operate within several kilometres of these cities, due the shock-waves they generate.

---

## **The Pacific 5000 Sub Race**

For the past 57 years, the Pacific 5000 has showcased the latest in civilian submarine design, with a variety of races, both short and long-endurance, for several types of subs. The Supercavitating designs are quite popular with the 3V viewers, as the effects of a rocket firing underwater are quite spectacular and supercavitating subs can attain speeds close to 800 kilometres per hour. Other races are more valuable for the designs and the Marianas Endurance Run is one of the most important for proving deep-diving vessels.

---

## ANTARCTICA

The original treaty commitments against settlement of Antarctica expired prior to World War III but implied agreement and a lack of recoverable resources restrained most nations from mounting more than research colonies. These bases, located in one of the most hostile environments on Earth, would play a role in the design of the first outposts on Mars and later around other stars. In the late 21<sup>st</sup> Century, both Argentina and Australia attempted to extract petroleum from Antarctica but costs and climate, along with international pressure, made the efforts unprofitable. Antarctica is still the site of many scientific outposts, usually under-staffed and under-funded, with living conditions little better than first stage colonial outposts.

Discovery of tantalum, however, could change all that. For various reasons, geologists believe that the Antarctic continent should contain tantalum deposits but extensive efforts over centuries have yet to uncover anything more than minute, unexploitable traces. Exploration is expensive and dangerous but continues on a low level.

*Great White South:* Argentina has experimented with resource exploitation in Antarctica for over 100 years but the difficulties have never been worth the expense. In the years since the third Rio Plata War, Argentina once again tried its hand at winning resources out of this hostile continent. They even built a large inland facility adjoining an ice-shelf and receive shipments via airship. Recently, however, British intelligence has become suspicious of this site and is quietly trying to get a closer look.

## ORBITAL SPACE

Earth orbit is a very busy place. Gateway Station can see upwards of several hundred ships a day and the volume of traffic is steadily getting higher. In addition to all the ship traffic orbit is filled with hundreds of factory and lab stations, solar power satellites, weather satellites, observation satellites and even hotels.

Several thousand people call orbital space home, even if only for limited tours on a small station or factory and thousands more visit monthly.

Low Earth Orbit (LEO) extends from 180 kilometres to 1,500 kilometers above the Earth and is occupied by a variety of transfer stations and factories. This is the most densely settled region of orbit, so dense that Orbital Traffic Control Regions (OrCons) had to be established. Each of the three OrCons is named for the space station they are centred on: Johnson, Mbele and Qin. Low orbit is also the location for most weather and observation satellites.

*Geosynchronous Orbit (GEO):* This orbit is at an altitude of just over 35,000 kilometres above the Earth and is the domain of communications satellites and the power stations. None of these

*Tinkers:* There are several small companies that do nothing but provide repair and maintenance services to the many small stations and labs in Low Earth Orbit. These Tinkers, as they are often called, have their own small reaction-drive vessels and live in these ships or in small stations scattered through the halo of satellites and debris in this orbital zone. They know where everything is and are often overlooked by security forces. When not involved in maintenance contracts, they often turn to salvage operations and sometimes fail to check if a satellite is truly salvage or actually someone's property.

smaller stations have permanent populations but several of the larger ones do. GEO is relatively barren of manned stations, largely due to the cost in getting there. Even though this orbit is above the Van Allen radiation belts, increased exposure to solar wind and radiation makes shielding very important. The only permanent stations in this region are the ESA-controlled Gateway and the under-construction Indonesian station of Mataglap.

*Gateway: UWP A00044A-C* Midway along the Beanstalk sits Gateway Station, the commercial hub of Earth space and home to over 7,000 people. This massive station has two habitation rings, each with three primary levels and construction is underway on a third ring. Spreading out from the station's core are kilometres of docking bays, warehouse modules and temporary storage. Hundreds of ships a day call at Gateway, from small couriers to massive bulk freighters bearing ore from



asteroid mines. Gateway is also the headquarters for the OQC, who share responsibility for the policing of the station with the French government.

Security on Gateway is extremely tight and is perhaps even more omnipresent than on the surface. Nonetheless, not every corner of this huge station can be monitored and there is a thriving black market in off-world goods, including drugs and biologicals.

### **BEYOND ORBIT**

Farther out than the orbital stations lie the lunar settlements and the great habitats residing at the LaGrange Points leading and trailing the moon.

### **L5 UWP B06376A-C**

The European Space Agency selected the LaGrange point trailing Luna for its space settlement. The first module was thrust into place in 2112 and the structure was completed in 2126. This old and immense structure is known by a simple name, L-5 and is the largest and most-heavily populated orbital structure in Human space.

L-5 is not so much a space station as a city – a city of nearly 72,000 inhabitants from 39 nations, fully self-supporting, prosperous from trade and its own industries and possessed of a unique culture and character.

Its appearance is spectacular. The massive station consists of two cylindrical habitats, each 30 kilometres long and four kilometres in diameter, with three immense mirrors that reflect sunlight into the windows below, illuminating the interior of the habitat. The half-sphere end caps of each jut with docking armatures, antennae, cranes, construction docks and towers. Space for 100 kilometres around L-5 is crowded with ships, workshacks and solar collectors up to 100 hectares in area.

### **L-4 UWP B06277A-C**

America placed the first space settlement at the LaGrange point preceding Luna. Soon Japan and Argentina placed their own settlements at L-4. Originally, America objected to neighbours at L-4 but the cross-fertilisation of technicians and scientists in close proximity and the natural trade that arose between the neighbours soon turned that opinion around. Over the succeeding decades, many nations placed stations and platforms here, including many corporations. As a result, there is a veritable constellation of stations at the L-4 point, in contrast to the singularly massive constructs at L-5. The largest of the L-4 stations is the American settlement of Goddard Station, a Bernal-sphere-type habitat approximately five kilometres in diameter housing nearly 50,000 people. Another four dozen or so stations, from many different nations and corporations, complete the array of settlements in this zone, with a combined population of over 150,000.

### **Luna UWP B30087A-B**

The Moon was the site of extensive settlement prior to the discovery of the stutterwarp and even now it has major cities

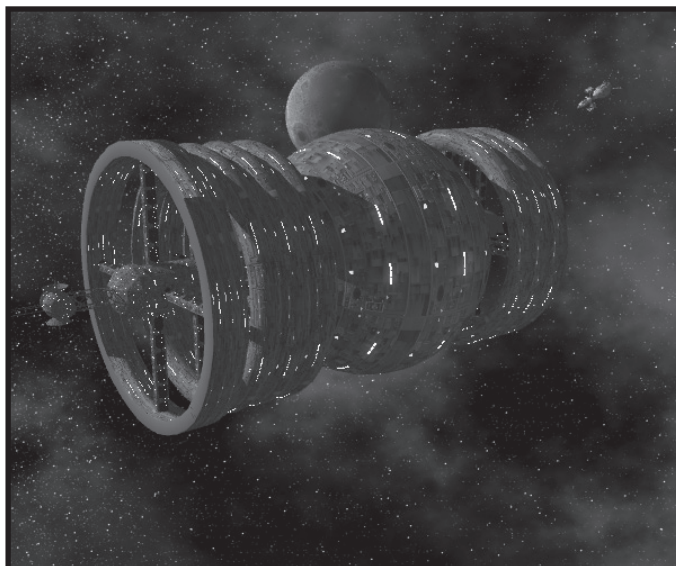

*Workin' in the Helium Mines:* Aside from tantalum, one of the most strategically important resources in Human space is Helium-3, used to fuel the fusion reactors that provide the power for most large military starships. For Earth, the Moon has always been a large supplier. Recently, however, stored Helium-3 has started going missing and the Lunar Authority is getting worried.

and settlements, with a population close to six million. The major business of the Moon is mining, in particular the strip-mining of Helium-3, which is used as fuel for modern fusion reactors. He3 mining uses equipment that resembles a farmer's combine and sifts through the top three or five metres of dirt and dust to obtain the precious helium. Other valuable elements are also available from the lunar crust, including titanium, aluminium and silicates, all industrially useful minerals, even in the age of synthetics.

### **TIRANE, Alpha Centauri A + B**

The first world out from Sol, Tirane is by far the single most important Human colony world. The oldest of the colonies, Tirane is a hub of commerce for virtually all other colonies and outposts.

Proxima Centauri, a distant companion of the central stars, is the closest star to the Sol System but has little to offer save a small iceball of a planet called Niflheim.

The L-4 stations have long been a conduit for contraband to Earth. Beyond the jurisdiction of the OQC, many of the smaller stations are virtual havens for bio-smugglers and drug-runners. Every so often, America or one of the larger stations tries to do something about the situation but they keep running into diplomatic hurdles. The OQC tries to keep a sharp eye of these smaller stations but since most traffic is reaction drive rather than stutterwarp, comings and going from these stations are hard to track.



## SYSTEM DATA

### Stellar Data

X, Y, Z Coordinates: -1.7, -1.4, -3.9

Number of Planets (Alpha Centauri A): 3 (Tirane, Oikemenos, Neuerde)

Number of Planets (Alpha Centauri B): 6 (Sheol, Hades, Limbes, Enfer, Vorholle, Purgatoire)

Other planets (Orbiting both stars): 6 (Gallia, Britannia, Italia, Germania, Hispania, Lusitania)

## NOTABLE PLANETS

### Limbes UWP X7A0227-8:

Limbes is a former garden world sterilised by a runaway greenhouse effect and it is of interest only to scientists and a few crackpots.

A joint ESA research station is maintained in orbit around the world, although its staff levels have been drastically reduced as the years have passed and other, more interesting worlds have been discovered. Despite almost a century of study, no surviving life forms have been detected but fossil evidence indicates a rich biosphere just under a billion years ago. Over 1,800 separate genera have been described; although their exact relationships remain tentative since most of the remains are fragmentary.

### Sheol UWP X9B0000-0

Sheol is a hothouse with fairly large mineral deposits but the atmosphere and climate are particularly harsh and the world remained unexploited because there were more economically exploitable deposits of the same minerals elsewhere in the system.

## PLANETARY DATA

### Planet Data

Name: Tirane

Distance from Primary: 0.97 AU

Year Length: 345 days

Size: 12,900 km in diameter

Day Length: 22.31 hours

World Type: Garden

Surface Gravity: 1.01 G

Atmospheric Pressure: 1.02 ATM

Climate: Temperate

Water Presence: 74%

Atmospheric Composition: N<sub>2</sub> (79%), O<sub>2</sub> (18%), Trace (3%)

Biodiversity: Diverse; usable

Resources: 7

Satellites: 2 (Esa and Europas)

The biosphere on Tirane is a mixture of native and off-world types. The primary introductions are from Earth but a few other worlds have contributed lifeforms as well. The biochemistry of Tirane was similar enough to Earth's that little had to be done to adapt Terran life to the world. This was a blessing and a curse to the early colonists; they and their livestock could eat the local

## Farm Troubles

Tirane has been shifting from Grandwinter to Grandspring and temperatures are rising. As a result, farm contracts are being renewed. However, there has been an increasing movement to automated farming and many of the previous family contracts are not being renewed. This has led to massive protests in Nouvelle Provence, Freihafen and Wellon, along with scattered outbreaks of violence.

plant and animal life with minimal problems but the reverse was also true. Careful survey work (the identification of potential disease-causing organisms and the preparation of appropriate countermeasures) kept problems with disease to a minimum. All colonists and their livestock were inoculated before they arrived and strict quarantine procedures were in effect from the start. The larger forms of life on Tirane were not difficult to deal with – fences and various environmental barriers kept the local equivalent of wolves from the colonists' meat animals and kept the local herbivores out of the grain fields.

There were a few problems but by-and-large, the various colonisation efforts have integrated themselves well into the local ecology.

## Grand Seasons

In addition to the normal seasons caused by orbital conditions and axial tilt, there are 'grand seasons' caused by the proximity of Alpha Centauri B. Although the radiation from Alpha Centauri B is not significant by itself (even at its closest approach, the companion star only comes within 11 AU), the few degrees added are enough to change the climatic zones of the world. These 'grand seasons' each last 19.75 years and are similar to regular seasons, only more drawn out. Grandwinter makes the planet a few degrees colder, while Grandsummer make it a few degrees warmer. Grandautumn and Grandspring are the heralds of the gradual changes to the other two Grandseasons.

Because of the constantly shifting weather, farming has taken on a unique pattern. Instead of individual family farms, a system of farming corporations has arisen. A corporation will own large tracts of land in several locations and a given tract of land will be used for various purposes depending on the season and grand season. Farm families will often undertake to farm a section of land for long-term periods (20 local years is an example of a standard contract). This laid the groundwork for the current system of corporate ownership of land and resources.

As a colony's climate shifts, the employment demands of agriculture also shift and the population transfers from agricultural jobs to other jobs on a cyclical basis. Farm workers could be said to be migratory in one sense but since they often spend two or more generations in one place, their life is relatively stable compared to other migratory agricultural workers.

## **COLONIAL HISTORY**

Tirane is a garden world in the Alpha Centauri system and the site of the oldest human colonies in space (there are older outposts but Tirane was the site of the first attempts at full-scale colonisation). It was a tremendous coincidence that Alpha Centauri had a world similar to Earth but this coincidence spurred the search for other such worlds. Had the system not contained any worlds suitable for human habitation, the course of future interstellar exploration might have been considerably different.

The first interstellar probe (an unmanned vehicle, launched under the auspices of the ESA) arrived in system in 2137 and made a detailed survey of the constituent worlds. The probe dropped an instrument package on Tirane, which included the flags of the member nations of the ESA. On the basis of this, when the data about Tirane arrived back on Earth, the member nations of the European Space Agency (at the time, the active members were France, Bavaria, Azania and the United Kingdom) announced their discovery and claimed the system for their exclusive colonisation. Several nations immediately filed diplomatic protests and began speeding up their interstellar programs. Argentina (in concert with Mexico) sent a probe to the system in 2138 to establish their claim to it. American and Japanese probes soon followed but no human had yet set foot on the world. Oddly enough, Manchuria was the only major power to support the ESA, although many remained neutral (especially those without hope of an interstellar exploration program). In 2149 a joint ESA survey party went into orbit around Tirane and spent the next four years studying the first world outside the solar system found suitable for human life. The party landed and planted flags, reasserting their claim to exclusive colonisation.

The ESA began construction of a large fleet of interstellar transports with a view to colonisation, including many converted interplanetary freighters. Other nations followed suit, but Argentina quickly converted several transports to warships and sent them to Tirane. The Alpha Centauri War was the result.

Most of the war was conducted in the Alpha Centauri system: the Argentinean armed transports battling the hastily armed merchant ships of the ESA. Neither side could gain a clear advantage but both sides were unwilling to expand the conflict to Earth.

When Australia offered to mediate, the two sides concluded a cease-fire which turned into an armistice. Both sides later claimed victory and the war is still a touchy subject in some circles.

The Melbourne Accords ended the war but also opened Tirane to settlement by all spacefaring nations and established the precedent of open settlement, which continues to this day (although somewhat modified). The nations of the ESA had a head start, however and Tirane's present demographic situation reflects this. A majority of the planet's 1.2 billion inhabitants are descendants of the ESA colonists. Several colonies failed for one reason or another and were absorbed into one or another of those listed.

## **Surveillance on Tirane**

Even though the nations of Tirane are far younger than those of Earth, they have still adopted the high-surveillance society of Earth. This is partly due to pressure from Earth but is also due to the great comfort of the citizens of this world and their desire to keep things that way. Tirane is no longer a frontier.

The two moons of Tirane, Esa and Europos, were named after the European space agency and the continent of Europe, respectively and they currently contain nothing but a few small observatories, research facilities and navigational beacons. There are several orbital colonies, each holding upwards of 10,000 people and large factory complexes orbiting Tirane, including the massive shipyards of Nouvelle Provence, Freihafen and Tirania. Along with the factories, there are nine solar power satellite arrays and numerous communications and land-use satellites.

Although Tirane is sparsely settled compared to Earth, the long period of settlement has led to social conditions similar to the home world, where security and safety are taking precedence over concepts of individual freedoms. In part as a result of this trend, a large surplus population has left to settle in the outer fringe colonies. As the frontier areas of Tirane became more civilised and opportunities for land begin to dry up, increasing numbers of colonists have emigrated from Tirane to other worlds where a person can make a fresh start, get in on the ground floor and generally escape from the pressures of civilised life (such as surveillance cameras and identicards). In many ways, Tirane has become a second Earth. The Law Level on Tirane is slightly more tolerant than that of Earth, with most nations banning non-hunting firearms outright (Law Level 7) unless a person shows a demonstrable need.

## **Colonies and Nations**

There are numerous individual colonies on Tirane. However, Tirane boasts the largest population of any colony world, although its 1.4 billion inhabitants are sprinkled rather thinly across the continents – Tirane's overall population density is fairly sparse.

### ***Nouvelle Provence UCP B956847-C Ri In 2 0***

*Date Founded:* 2167

*Major City(s):* Nouvelle Paris (2 million), Nice-sur-Tirane, (1.2 million)

*Currency:* Livre

Now a department of metropolitan France, Nouvelle Provence is the location of France's largest starship construction facilities, the Université du Tirane, the Institut des Études Exobiologiques' (IEX's) extensive zoological collection and the famed Musée Xenologique. Without rival, Nouvelle Provence is the cultural capital of Tirane.

Although still a colony, Nouvelle Provence enjoys a great deal of power in the Chamber of Deputies in France. Her population is more than double that of European France and easily surpasses all non-European French territories on Earth.

In addition to being the cultural centre of Tirane, Nouvelle Provence is also the centre of French commercial shipbuilding. While most of the military ships are laid down in the orbital yards above Earth, Nouvelle Provence is responsible for over 60% of the civilian ship construction in French space and has the largest commercial yards in the French Arm or indeed anywhere outside of the Sol system.

### **Freihafen UNP B968846-C Ri In 2 0**

*Date Founded:* 2167

*Colony Name:* Freihafen (formerly Garten)

*Major Cities:* Neumunchen (3.1 million), Freistadt (1.7 million), Ceske Vary (1.1 million)

*Currency:* Freihafen Thaler (NOT Taler)

This former Bavarian colony was unwilling to become a part of a reunited Germany and is now an independent nation. Relations with the rest of the colonies are better for it, since a strain between two large colonies on Tirane would have possibly created a global conflict or economic hardship. Freihafen is heavily industrialised and is noted for the manufacture of heavy vehicles and machine tools both for internal use and export. Freihafen is one of the richest and likely the most powerful, extra-solar nations. Its economic clout is inline with many Earth-based nations.

### **Tudukubwa UCP C566745-A Ri Ag Ni 7 0**

*Date Founded:* 2167

*Major Cities:* Tudukubwa City (3.1 million), New Natal (800,000)

*Currency:* Azanian Rand

The Azanians made only a small effort on Tirane initially. Along with Nouvelle Provence, Freihafen and Tunghu, Tudukubwa shares the largest of Tirane's seven continents. The colony itself is mostly concentrated in an original city complex built against a geologically recent crater (tudukubwa means great hole). Mines which used to be operated in the pit of the crater have long since gone out of business but the colony's roots and centre are still there. With the collapse of the mining, the economy has become more centred on agriculture, producing luxury crops for consumption across human space.

It is interesting to note that Tudukubwa lacks the extensive surveillance and monitoring networks of the other nations. This is not, as often stated by other nations, due to a lack of technology or funding. It is a conscious choice on the part of the colony's

*Tourist Trade:* New Albion is the 'in' destination for wealthy travellers from both Tirane and Earth. In addition to the beautiful beaches and palatial estates, this colony also boasts many high-class casinos, race tracks and other leisure pursuits for the idle rich.

government and contributes to the relaxed atmosphere of the colony. Tourism has become a major industry, along with some other, less savoury enterprises that seek to take advantage of the lack of surveillance. However, this lack of surveillance does not mean that the colony is soft on crime. Rather, they use different methods to fight crime.

### **New Albion C489646-B Ag Ri 6 0**

*Date Founded:* 2167

*Major Cities:* Exeter (750,000), Newcastle-upon-Windsor (180,000), Kirkwall (90,000)

*Currency:* British Pound

British settlement of this colony was intense in the early days of colonisation but soon tapered off as other avenues opened up. Still, to many British, the colony at New Albion marked the rekindling of the long dead empire and the pride associated with it. Now the English have colony worlds along the entire French Arm but New Albion is arguably the 'national favourite'. Originally an agricultural and light industrial colony, New Albion is now also a retreat for the nobility and fiefs granted here are known for their lavish upkeep and luxurious appointments. For the first 40 years, Wellon was governed by New Albion, until the population and concerns of the larger colony outstripped the ability of the New Albion legislature to deal with them.

Wellon's subsequent independence had little effect on New Albion, as the balance of their trade was off-world and the two still maintain amicable relations.

### **Wellon B978847-C Ri In 2 0**

*Date Founded:* 2169 (independent in 2277)

*Nationality:* Independent

*Major City(s):* Far London (4.3 million), Lancaster (2.5 million), Cambridge (1.9 million)

*Currency:* Wellon Pound

Wellon was originally the industrial component of the two-pronged British settlement plan for Tirane and was governed from New Albion until achieving home rule in 2241.

Of the two portions of the British colony, Wellon attracted much more interest from colonists, as it had greater opportunities and settlers from many English-speaking nations favoured this colony as their first choice.

### **Military Buildup**

The government of Wellon is arguably one of the wealthiest in Human space. They have chosen to use much of this wealth in building up their military, both space forces and ground forces. They currently have one of the largest navies and perhaps the fourth largest army. The only question is: What are they going to do with them?

Wellon's economy grew rapidly, as did her population, surpassing that of Earth-bound Britain in 2245. With this economic power came a desire for greater autonomy and finally a strong desire to chart her own course, alongside Britain and the other Commonwealth nations. Britain's attempts to satisfy this desire led to home rule for the Wellon colony in 2241. This sufficed for a generation but by the 2270's, Wellon wanted more.

In 2277, after a national referendum, Wellon declared its independence from the mother country but still enjoys a close relationship. The island of New Albion elected to remain a Crown possession. Wellon is another colonial powerhouse and although the country has yet to establish its own colonies, it is actively surveying several promising worlds. There are talks of a joint British-Wellon colony in the Wolf cluster sometime in the next 10 years, with Wellon industry supporting British knowledge and experience.

New Albion is regarded largely as a curiosity by the inhabitants of Wellon and is their favourite destination for holidays, along with New Canberra.

### ***Tirania B589646-B 3 0 Ri***

*Date Founded:* 2167

*Nationality:* American

*Major Cities:* New Washington (2.2 million), Montgomery (1.6 million), Tirania City (990,000)

*Currency:* American Dollar

American settlement on Tirane was never extensive and was carried out largely by private corporations. As an interesting side note, no American colony has ever been named New America, as this phrase has a bad connotation to them (it refers to an extremist movement of the late 20th and early 21st Centuries). Tirania had been on the brink of being labelled a 'failed colony' as the local population had been in decline for over a decade.

### ***New Canberra C687646-B 6 0 Ag Ri***

*Date Founded:* 2167

*Nationality:* Australian

*Major Cities:* Port Ayers (12 million), Caroline (5.5 million),

*Currency:* Australian Dollar

The Australians received colonial guarantees on Tirane as a result of the Melbourne Accords and claimed them immediately. The Australian colony's main claim to fame was that it was the site of the so-called 'First-and-a-Half Interstellar War' between Australian and Japanese survey teams over a major tantalum strike.

*New Canberra Population:* Fans of the old 2300 AD will notice a discrepancy between the population figure here and that published in the original Colonial Atlas.

With a population just more than double that of the home country, elements of New Canberra society have recently begun agitating for some variety of home rule. It is expected that they will receive it with 10 years and likely be independent in 20.

### ***Amaterasu B69A747-C 1 0 Ag, Ri***

*Date Founded:* 2167

*Nationality:* Japanese

*Major City(s):* New Tokyo (6.5 million), Miyazaki (4.5 million), Sapporo (2.6 million)

*Currency:* Japanese Yen

For reasons which were never completely clear, Japanese survey teams began staking out claims which overlapped those of Australia. The situation was complicated by the fact that tantalum was discovered in the disputed area (called 'Duffer's Strip' by the Australians) and several small-scale skirmishes resulted between Australian and Japanese survey teams before a mutually satisfactory settlement could be negotiated. The strip went to the Australians but the tantalum would be mined by a joint Australian/Japanese corporation.

*Religion:* Religion is still very important in 2300AD. The major religions of the 20th Century still survive, along with some new ones. However, religion is a private affair, especially in the Core. Here is a brief (and incomplete) list of the religions active in 2300:

Roman Catholic, Greek and Russian Orthodox, Anglican, Lutheran, Presbyterian, Baptist, Pentecostal, Unitarian, Latter-Day Saints, Society of Friends, Islam, Judaism, Shinto, Buddhism, Community of Sentients, Wicca, Hindu and Native Spiritualism.

Since that inauspicious start, the Amaterasu colony has become the main source of tantalum for the Japanese shipbuilding industry, although the limited amount allowed under the treaty has Japan constantly on the lookout for additional sources.

Amaterasu is still a favoured destination for Japanese colonists, close to Earth in distance and culture but still less restrictive than the home islands.

Amaterasu has recently started importing deep-sea construction technology from Earth and began to build an undersea city 350 kilometres off their coast, near a series of dormant undersea volcanoes that have good prospects for tantalum reserves.

### ***Provincia do Brasil C768857-A 1 0 Ag Ri***

*Date Founded:* 2167

*Nationality:* Brazilian

*Major City(s):* Belo Horizonte (3.2 million), Salvador (2.2 million), Valadares (1.3 million)

*Currency:* Real

Brazil became a spacefaring power on the basis of its native tantalum deposits and purchased American and French technology in order to construct ships. Their colony on Tirane is still their proudest interstellar achievement and is the equal of the mother nation in most, if not all, ways.

Provincia do Brasil is a well-developed nation and is starting to feel the urge of self-direction. The home nation recognises this and steps are under way to grant the colony an increased measure of autonomy, although short of outright independence. Provincia do Brasil is widely known for the production of specialised luxury foods, along with its famed airship industry, probably the most advanced of its type in Human space.

### ***Tunghu C399665-B 3 0 Ri***

*Date Founded:* 2167

*Major City(s):* Harbin (2.2 million)

*Currency:* Manchurian Ruble

Manchuria was never overly interested in settlement on Tirane, having decided to exploit other possibilities in interstellar colonisation. Nevertheless, Manchuria purchased a small area in one of the Bavarian claims (approximately 300 square kilometres), in order to maintain trade contacts. The small trade centre is now a bustling metropolis and duty-free market for goods from all over human space. Its position literally in the shadow of the Freihafen beanstalk gives it unequalled access.

Harbin is the central city of the territory, holding most of the population. The outlying towns are the controlled suburbs for the elite of the city. The Tunghu colony exerts a greater degree of control over its citizens than the other colonies on this world (Law Level 9), resulting in more restrictions on personal freedoms. Given their lifestyle, however, the citizens on Tunghu seem little inclined to protest the restrictions.

### ***Santa Maria C787645-B 9 0 Ri***

*Date Founded:* 2167

*Major City(s):* Córdoba (790,000), Comodoro Kimball (430,000)

*Currency:* Argentine Peso

Despite all the rhetoric surrounding the Alpha Centauri War, Argentina was never able to mount a successful colony on Tirane. Only sheer stubbornness has kept the colony alive. Argentina had originally chosen its location on the basis of stolen ESA survey data that indicated the site would have large mineral reserves, in particular tantalum. It was not until years later that INAP agents discovered that the report had been altered and leaked to the Argentineans in an attempt to marginalise them.

Lately the Argentine colony has been using technology developed for deep-sea mining on Earth to explore and exploit resources along the mid-ocean rift system that the island colony straddles. These efforts have begun to yield results but the Argentine claim is in contention, as the region they are mining is in international waters and Wellon and Nouvelle Provence dispute their claim.

### **NATIONAL ENCLAVES**

Aside from the large national colonies outlined, Tirane is also home to many smaller operations from many different nations. These small enclaves rarely get above 100,000 people and are usually located in or near the territory of an allied nation. So Canada's is near Wellon, Greece's is near Provincia do Brasil and so on.

The following nations maintain enclaves on Tirane:

Austrovenia, Canada, Canton, Greece, Incan Republic, Indonesia, Italy, Mexico, Nigeria, Scandinavian Union, Spain, Texas, UAR and Ukraine.

# FRONTIER WORLDS

## HOMO SAPIENS SAPIENS ELLIS

Lee drank deep from the canteen that hung from the roof of his tractor and looked out over the day's work with a tremendous feeling of satisfaction. Two years ago he had been on Earth, slogging through his days in a job that felt more claustrophobic by the hour. Trapped in a dull, meaningless life, alone and hating it. And he had been growing tired. Tired of the invasive surveillance cameras, tired of the mindless 3V and the stifling lack of control in this automated world. Tired of everything. And to top it off, his participation in a number of lively but innocuous on-link discussions had netted him a visit from a couple of earnest young agents from the National Security Office. That had been enough, the final argument for him.

Five days later he had sold everything he owned and bought a one-way ticket to Ellis. The trip had taken two months, during which he studied off-world farming theory, learned the history and geography of Ellis and relished being able to speak his mind without fear of reprisal. The injection of the DNA-modification retroviruses on Gateway Station had made him tired and irritable and the first time that he urinated crystals instead of water caused him a brief stint in the ship's sick bay. It was the nictitating membrane that had freaked him out the most, though, blinding him for five days while it developed. He realised why the doctors recommended sleeping through the two-month transit to Ellis. He grew taller and thinner over the course of 10 painful days. By the time the transport warped into orbit over Ellis, he was the physical model of an Ellis settler.

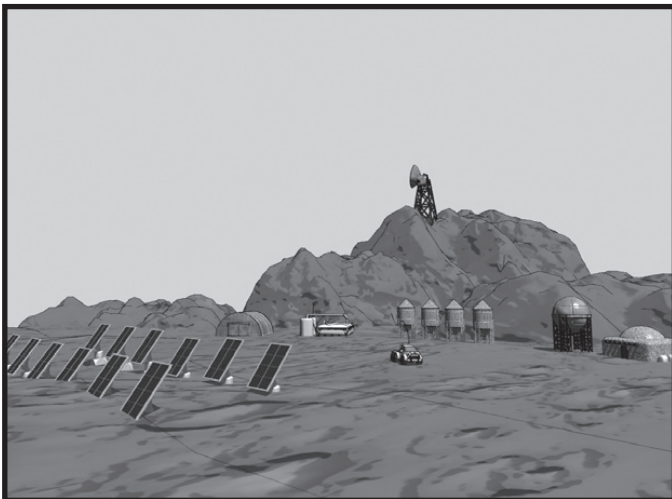

On arriving at Ellis he made the trip to the land claims office and received a parcel of land, 1,000 hectares, with another 1,000 being available if he could turn a profit on his first 1,000 within three years. Armed with the deed and 5,000 dollars in his pocket, he made his way to the Colonial Bank. An hour later he walked out a quarter-of-a-million dollars in debt, the proud owner of a fuel-cell powered tractor and a complete modular homestead setup. The government supplied his first crate of g-mod seeds, too, part of the colony support program. The lectures from the Alberta Farmer's Co-op reps had consumed a full day, at a time when he all he wanted was to blacken his hands with his own dirt. He had begrudged them the time then but the future would prove the wisdom of attending the lectures.

Two years ago, he had started out at the end of the line, 12 kilometres from Nanton, the nearest settlement, with nothing but his gear and a connection to the irrigation network. He ran that tractor day and night, pausing only to refuel, refresh or repair. During the day, he worked his fields, breaking the land, then running the irrigation lines. During the long nights, he ran the tractor for power, lighting his new greenhouses, his shop and even his small home. He learned how to run the fabricator, to make new parts to repair those that broke under the abuse he subjected that tractor to.

Back on earth, in his housing complex, he had not known any of his numerous neighbours by sight or by name. Here, he had a handful of fellow farmsteaders, including a young couple who were as new to the colony as he was. A short distance away was an old hand, a third-generation colonist, along with a fourth generation who peered shyly at him from under a battered Cat-Fusion cap. That man and his daughter taught him far more about Ellis than any book. In his turn, he passed along advice to the young couple, who were struggling with their new life in these sere deserts. Not like they could choose to leave. Once the retroviruses completed their work, there was no going back to earth.

## LIFE ON THE FRONTIER

Life on the Frontier is a mix of the primitive with the high-tech. A house might be made out of rammed-earth blocks but support a satellite uplink to a link grid, with a solar power array in the back yard supplying power to an integrated kitchen module dropped off by airship. The bathroom, however, may be a little shed out back with a composting toilet and little else.

The nearest town might have 50 houses and a general store or it may be a metropolis of 10,000, with real restaurants and services. Horses will mix on the streets with fuel-cell-powered tractors and hovercraft, while the sky above sees flights of airships and spaceplanes.

The urban areas on any long-settled world will be similar to urban areas in the Core, although there are key differences. The lack of pervasive surveillance is one of the most important ones. Cities tend to be lower and more spread out as well, more open, with plentiful green space. Most frontier cities are either very well planned or else studies in complete anarchy. There is no middle ground.

Most colony worlds have some sort of spaceport, which can range from a flat expanse of open ground to advanced ground terminals orbital catapults and orbital stations.

Life on the frontier is very different from life on Earth and Tirane. The pace is more relaxed, in particular for the agricultural colonies, less so for the mining colonies. On the frontier, there is not the constant sense of being watched, no surveillance cameras drifting through the sky. People can say what they want and live how they want. Most frontier worlds tend to be more socially conservative than their counterparts in the Core. Urban areas on frontier worlds do have a lot in common with the Core cities but everything seems muted. The signs are not as garish, the advertising not so loud. Few use implanted RFID chips, so the personalised ads of the Core are absent on the frontier. That alone is reason enough for many people to emigrate.

Planetary Adaptation Syndrome ensures that most permanent colonists will have DNA modifications to help them adjust, while shorter-term visitors will make do with a cocktail of drugs and adaptive symbiotes.

DNA modifications have proven incredibly useful in the colonisation of other worlds. However, since the DNA ban of the 2270s, public attitude in the Core has become increasingly intolerant of human genetic engineering, so much so that most Core nations have laws on the books to prevent colonists from returning to earth for more than 14 days without undergoing retrograde therapy to return them to baseline human. On Tirane, the grace period is 28 days instead, save in Tundukubwa, the only Core nation/colony that does not seem to care whether or not the people within its borders have undergone DNA modification. Once beyond those borders however, the 28-day rule applies.

## PLANETARY ADAPTATION SYNDROME

Humans are supremely well adapted to the conditions of life on Earth. This does not hold as true for other worlds. Every time a character journeys to any world other than their home world, they are subject to Planetary Adaptation Syndrome. Upon landing on a new world, a character must make a Difficult Endurance

check. Success at this check means the character has adapted to the planet's conditions and no further checks are required. After one week, if a character failed the first check, they must check again. This is a Formidable check and failure indicates that the -1 penalty is permanent while the character remains on the world.

### **DMs:**

Tainted Atmosphere: -2  
Atmospheric Symbiote: + 2  
DNA modification: +4 bonus.  
Drug therapy: +2 bonus,

Drug therapy is only supposed to be used for a period of up to three weeks. After that, a Formidable Endurance check must be made or Endurance will drop by one point per week until either it hits zero or the drug therapy is stopped. Once it is stopped, the character must make a Formidable Endurance check, using their current Endurance.

## DISEASE AND OTHER DANGERS

While 3V documentaries get made about Beowulf's dracoforms and Cold Mountain's Demons, it is the threats that cannot be seen that present the greatest danger to humans, their crops and their livestock. Roughly half of all colonial fatalities are due to a combination of disease, parasites, fungi and infections. Modern medical technologies can usually cure these infections but only if they are noticed and treated in time. Note that autodocs usually can do little more than buy time, as they are not programmed for complex diagnoses.

Any world with an active biosphere can harbour diseases and infections inimical to humans, even if the life forms are typically incompatible.

### **Diseases**

Diseases reduce a character's Characteristics, usually Endurance. The character must make an Endurance check with the listed DM to resist the effects of the disease. If the character fails the Endurance check then he takes the listed damage and must make another Endurance check a few hours or days later, depending on the interval of the disease. Once an Endurance check has been passed, the character has fought off the disease. Some more tenacious diseases may require multiple successful checks to shake off.

### **DMs:**

Non-compatible biosphere: +2  
DNA modification for that world: -1 (yes, being modified for a world makes a character MORE vulnerable)  
Bioweapon: -4 (Bioweapons also shift the interval down one category, weeks become days, days becomes hours and hours becomes minutes.)

| Disease Virulence | DM | Damage |
|-------------------|----|--------|
| Mild              | +1 | 1d6    |
| Normal            | 0  | 1d6+2  |
| Moderate          | -1 | 1d6+4  |
| Serious           | -2 | 1d6+6  |
| Lethal            | -3 | 1d6+8  |

The interval of a disease is determined separately from its severity. The common cold has on set of 1d6 days, while SARS, a Serious infection, has an onset of 1d6 hours.

| Disease Virulence | Interval  |
|-------------------|-----------|
| Mild              | 1d6 weeks |
| Normal            | 1d6 days  |
| Moderate          | 1d6 days  |
| Serious           | 1d6 hours |
| Lethal            | 1d6 hours |

*Examples:* The common cold is mild. Pneumonia is normal. Tuberculosis is serious, while ebola is lethal.

The Nous Voila plague was a moderate infection (DM -1, DM -2 for DNA modified colonists) with an onset of 1d6 weeks.

Glass mites are a serious parasitic infection common on Cold Mountain, with an onset time on 1d6 days.

## COLONIES

The following table identifies three different types of settlements. An outpost can be one of several things. Most outposts are way stations on the routes between stars, existing as refuelling and repair stations. Some outposts are mining or science settlements in otherwise inhospitable systems. The last category

for outposts is a colony precursor, a small settlement designed to test and prepare for a full-fledged colonisation effort. Colonies are large settlements on clement worlds, typically subordinate to a controlling nation, Foundation or corporation. Enclaves in this context are small settlements or embassies on an alien-controlled world.

### NOTES ON THE UWP

The UWP, Universal World Profile is a component of all versions of *Traveller* and related games. It is a shorthand description of a planet, for both physical and social aspects.

In *2300AD*, the meaning of the first digit has been changed to reflect the nature of the setting. In most versions of *Traveller* this is the starport type for a world. Given the costs and difficulty of interface travel in *2300AD*, this digit instead describes the type of interface transport publicly available. Each type assumes that all other lower grades of interface travel are available.

- A Beanstalk
- B Catapult
- C Spaceplane
- D Roton
- E Cargo rocket
- X No publicly available interface transportation

Between 2167 and 2300, a total of 63 human colonies were established on 33 habitable worlds. In addition to these colonies, there are a large number of outposts and scientific, military and corporate bases scattered across dozens of worlds, only some of which are named in the previous table. These colonies and outposts were founded by a wide variety of groups, for many different purposes.

In addition to the national colonies, three more were established by independent organisations: Tanstaaf on Aurore, Trilon's

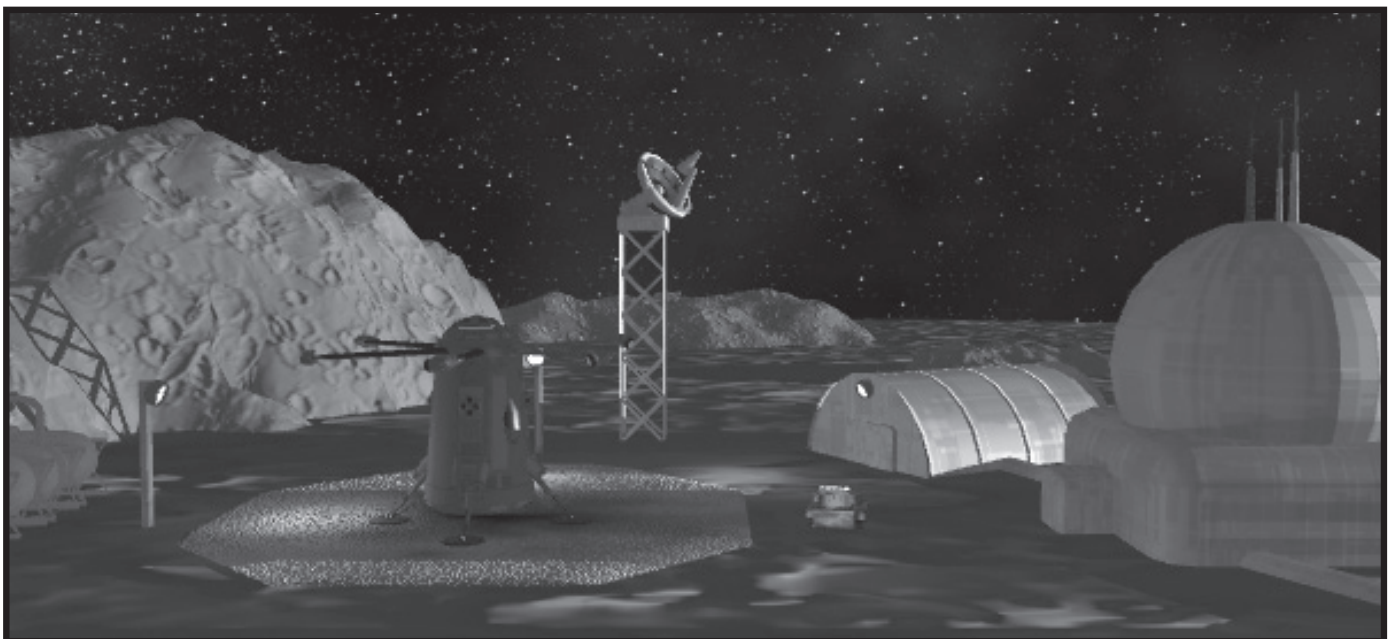



headquarters on Kie-Yuma and the Life Foundation colony of Cousteau on Austin's world. The world of Elysia won independence through armed revolution, while the colony of Tanstaaf, on the distant world of Aurore, gained its independence through the economic collapse of the corporations that had founded the colony.

## COLONIES AND TIERS

For currency values, colonies are considered to be on the same tier as their mother countries. In all other respects, however, they

should be treated as Tier 4 nations. The status of the independent colonies and the Foundation and corporate-controlled colonies varies.

| Stellar Nation | Tier |
|----------------|------|
| Wellon         | 2    |
| Freihafen      | 2    |
| Elysia         | 4    |
| Cousteau       | 3    |
| Tanstaaf       | 4    |

## Settlement List

| Nationality | System Name      | Type    | Colony Name         | Gravity | UWP       |
|-------------|------------------|---------|---------------------|---------|-----------|
| America     | Alpha Centauri   | Colony  | Tirania             | 1.01    | A867977-C |
| America     | Barnard's Star   | Outpost | FAR Station 1       | 0.71    | D7B0377-7 |
| America     | Broward          | Outpost | Armstrong Station   | 0.26    | B221286-8 |
| America     | King             | Colony  | New Columbia        | 3.08    | BD97675-B |
| America     | New Melbourne    | Outpost | FAR Station 7       | 0.39    | C331276-9 |
| America     | Mu Herculis      | Colony  | Hermes              | 0.73    | B668644-A |
| America     | Vega             | Outpost | FAR Station 5       | 0       | DS00289-B |
| America     | Red Speck        | Outpost | FAR Station 11      | 0.23    | B210388-6 |
| America     | DM-34 11626      | Colony  | Avalon              | 0.72    | D66A475-2 |
| America     | Ellis            | Colony  | Ellis               | 0.92    | B861666-9 |
| America     | AC+2 2155-242    | Outpost | FAR Station 19      | 0       | DS00289-7 |
| Arabia      | Beta Hydri       | Colony  | Far Riyadh          | 0.66    | B654777-B |
| Argentina   | Alpha Centauri   | Colony  | Santa Maria         | 1.01    | A867977-C |
| Argentina   | DM26 12026       | Outpost | Estación Escobar    | 0.97    | C602378-8 |
| Argentina   | Omicron2 Eridani | Colony  | Montana             | 0.98    | C769543-9 |
| Australia   | King             | Colony  | Huntsland           | 3.08    | BD97675-B |
| Australia   | Alpha Centauri   | Colony  | New Canberra        | 1.01    | A867977-C |
| Australia   | New Melbourne    | Outpost | Bandicoot Station   | 0.39    | C331276-9 |
| Australia   | Ross 863         | Outpost | Fisher Station      | 0       | C000386-6 |
| Australia   | Botany Bay       | Colony  | Botany Bay          | 0.91    | C769664-9 |
| Australia   | Zeta Herculis    | Colony  | Kingsland           | 0.99    | D766645-7 |
| Azania      | Alpha Centauri   | Colony  | Tundukubwa          | 1.01    | A867977-C |
| Azania      | Nyotekundu       | Outpost | Naragama            | 1.02    | B7A0479-7 |
| Azania      | Kimanjano        | Colony  | Okavango            | 0.94    | E799678-7 |
| Azania      | 61 Ursae Majoris | Colony  | Lubumbashi          | 1.05    | BA66675-A |
| Ex-Bavaria  | Rho Eridani      | Nation  | Heidelsheimat       | 0.44    | B867778-C |
| Brazil      | Alpha Centauri   | Colony  | Provincia de Brasil | 1.01    | A867977-C |
| Brazil      | DM21 1377        | Outpost | Eshari Station      | 0.69    | C6A5368-9 |
| Brazil      | Ross 614         | Outpost | Amazon Station      | 0.48    | C500469-A |
| Brazil      | Procyon          | Colony  | Paulo               | 0.99    | C967645-8 |

| Nationality | System Name        | Type    | Colony Name            | Gravity | UWP       |
|-------------|--------------------|---------|------------------------|---------|-----------|
| Britain     | Alpha Centauri     | Colony  | New Albion             | 1.01    | A867977-C |
| Britain     | Queen Alice's Star | Colony  | Alicia                 | 1.05    | B867775-B |
| Britain     | Clarkesstar        | Outpost | DeVilbis Station       | 0       | D000367-8 |
| Britain     | Beta Canum         | Colony  | New Africa             | 0.94    | A766775-B |
| Britain     | Henry's Star       | Colony  | Crater                 | 0.61    | B7516-7   |
| Britain     | 61 Ursae Majoris   | Colony  | New Cornwall           | 1.05    | BA66675-A |
| Britain     | Gamma Virginis     | Outpost | Warkington's Drift     | 0.68    | E656265-5 |
| Canada      | DM+19 5116         | Outpost | Come-by-Chance Station | 0.38    | D320366-6 |
| Canada      | DM+3 123           | Enclave | Stark                  | 0.83    | B767977-C |
| Canada      | DM+15 4733         | Outpost | Moosejaw Station       | 0.13    | D200366-6 |
| Canada      | DM+20 5046         | Colony  | Kanata                 | 0.87    | C768564-9 |
| Canada      | AC+17 534-105      | Colony  | Eriksson               | 0.93    | D664464-4 |
| Canton      | Zeta Tucanae       | Colony  | Lihngtou               | 1.02    | B867665-A |
| France      | Kimanjano          | Colony  | Fromme                 | 0.94    | D778676-8 |
| France      | Beta Comae         | Colony  | Nous Voilà             | 1.05    | X965500-0 |
| France      | Vogelheim          | Colony  | Adlerhorst             | 1.16    | C986625-9 |
| France      | Eta Bootes         | Colony  | Aurore                 | 0.73    | C666674-B |
| France      | DM+27 28217        | Outpost | Bon Chance             | 0       | C000378-A |
| France      | Bessieres          | Outpost | Bessieres Station      | 0.58    | C431369-A |
| France      | Augereau           | Outpost | Augereau Station       | 0.47    | C4A0369-9 |
| France      | Serurier           | Outpost | Serurier Station       | 0.21    | B201469-B |
| France      | Alpha Centauri     | Colony  | Nouvelle Provence      | 1.01    | A867977-C |
| France      | DM26 12026         | Outpost | Point de Voie          | 0.97    | C602378-8 |
| France      | Davout             | Outpost | Ville de Glace         | 0.76    | B635478-8 |
| France      | Nyotekundu         | Outpost | Inferno                | 1.02    | B7A0479-7 |
| France      | D'Artagnon         | Outpost | D'Artagnon Station     | 0.65    | C772468-5 |
| France      | Queen Alice's Star | Colony  | Europe Neuve           | 1.05    | B867775-B |
| France      | Beta Canum         | Colony  | French Continent       | 0.94    | A766775-B |
| France      | DM+36 2219         | Outpost | Sans Souci             | 0.99    | C766565-4 |
| Germany     | Alpha Centauri     | Colony  | Freihafen              | 1.01    | A867977-C |
| Germany     | DM+36 2393         | Colony  | Dunkelheim             | 0.6     | B464544-A |
| Germany     | Hochbaden          | Colony  | Hochbaden              | 0.29    | X400000-0 |
| German      | Neubayern          | Colony  | Nibelungen             | 0.63    | B463844-B |
| Germany     | Beta Canum         | Colony  | German Continent       | 0.94    | A766775-B |
| German      | Vogelheim          | Colony  | Adlerhorst             | 1.16    | C986625-9 |
| Germany     | 61 Ursae Majoris   | Colony  | Halbinsel              | 1.05    | BA66675-A |
| Germany     | Augereau           | Outpost | Hunsrück Station       | 0.47    | C4A0369-9 |
| Germany     | DM-56 328          | Outpost | Geroellblock           | 0.25    | C200468-8 |
| Inca        | Rho Eridani        | Colony  | Machu Picchu           | 0.44    | B867778-C |

| Nationality       | System Name       | Type    | Colony Name      | Gravity | UWP       |
|-------------------|-------------------|---------|------------------|---------|-----------|
| Inca              | DM3 1123          | Colony  | Sechura          | 1.25    | BA8967A-9 |
| Independent       | Eta Bootes        | Colony  | TanstaafI        | 0.73    | C666674-B |
| exBritish         | Alpha Centauri    | Nation  | Wellon           | 1.01    | A867977-C |
| Ex-French         | 61 Ursae Majoris  | Nation  | Elysia           | 1.05    | BA66675-A |
| Japan             | Alpha Centauri    | Colony  | Amaterasu        | 1.01    | A867977-C |
| Japan             | Davout            | Outpost | Shungen          | 0.76    | B635478-8 |
| Japan             | Beta Hydri        | Colony  | Daikokou         | 0.66    | BA54777-B |
| Japan             | 61 Ursae Majoris  | Colony  | Tosashimizu      | 1.05    | BA66675-A |
| Life Foundation   | DM+3 1123         | Colony  | Cousteau         | 1.25    | BA8967A-9 |
| Manchuria         | Alpha Centauri    | Colony  | Tunghu           | 1.01    | A867977-C |
| Manchuria         | Barnard's Star    | Outpost | Fuyuan Station   | 0.71    | D7B0377-7 |
| Manchuria         | DM26 12026        | Outpost | Zhong Ba Station | 0.97    | C602378-8 |
| Manchuria         | Delta Pavonis     | Colony  | Cold Mountain    | 0.83    | C674766-8 |
| Manchuria         | Xiuning           | Outpost | Xiuning          | 0.7     | D630368-5 |
| Manchuria         | Epsilon Indi      | Colony  | Chengdu          | 1.12    | B797745-B |
| Manchuria         | Hunjiang          | Outpost | Hunjiang         | 0.33    | D311368-6 |
| Manchuria         | Zeta Tucanae      | Colony  | Chyuantii        | 1.02    | B867665-A |
| Manchuria         | Serurier          | Outpost | Serurier         | 0.21    | B201469-B |
| Manchuria         | Tau Ceti          | Colony  | Kwantung         | 0.93    | B667775-B |
| Manchuria         | Epsilon Eridani   | Colony  | Dukou            | 1.57    | BA8051A-8 |
| Manchuria         | DM15 6290         | Outpost | Yinchuan Station | 0.86    | D778457-8 |
| Manchuria         | Haifeng           | Outpost | Heaven's Water   | 0.81    | C76A565-6 |
| Manchuria         | DM+1 4774         | Outpost | Bayan Obo        | 0.37    | C342368-5 |
| Manchuria         | DM+4 123          | Enclave | Stark            | 0.83    | B767977-C |
| Mexico            | Omicron2 Eridani  | Colony  | Montana          | 0.98    | C769643-9 |
| Mexico            | Tau Ceti          | Colony  | Kwantung         | 0.93    | B667775-B |
| Pentapod          | Beta Canum        | Enclave | Beta Canum       | 0.94    | A766775-B |
| Texas             | DM31123           | Colony  | Austin's World   | 1.25    | BA8967A-9 |
| Texas             | Rho Eridani       | Colony  | Alamo            | 0.44    | B867778-C |
| Texas             | 82 Eridani        | Enclave | Kormoran         | 1.46    | XA87874-3 |
| Trilon Corp       | Xi Ursae Majoris  | Colony  | Kie Yuma         | 1.21    | BC97618-C |
| Trilon Corp       | DM+5 3993         | Outpost | Trilon 14        | 0.00    | B000619-B |
| UAR               | 82 Eridani        | Enclave | Nasser           | 1.46    | XA87874-3 |
| Ukraine           | Eta Bootes        | Colony  | Novoya Kiyev     | 0.73    | C666674-B |
| Transhuman League | Van Maanen's Star | Outpost | Sandberg         | 0.08    | D000303-9 |

The national colonies enjoy a wide variety of relationships with their home governments. Some remain virtual protectorates, their external affairs managed by the mother country, while others enjoy home rule and send representatives to the national legislatures. In addition to the colonies, there are numerous manned outposts on uninhabitable worlds or in deep space orbit around star systems. These serve as scientific research centres and refuelling way stations on important star routes.

Along with these colonies and outposts, there are also four major human enclaves on worlds inhabited by indigenous intelligent races, two each on Stark (DM+4 1233), the Sung homeworld and Kormoran (82 Eridani4), the Eber homeworld.

It is easiest to examine the colonies in terms of explored 'arms', the naturally occurring corridors of colonisation that result from stellar geography. There are three arms and they are almost universally referred to as the American, Chinese and French Arms, after the major powers that have dominated their exploration and colonisation.

## DESCRIPTION OF TERMS

### STELLAR DATA

*Primary Name:* Name of the primary star in the system. There can also be companion stars.

*X, Y, Z Coordinates:* Location of the star on the map, with the Earth system at 0,0,0.

### COLONY DATA

*UCP:* The Universal Colony Profile

*Colony Name:*

***Nationality:*** Establishing nation

## THE AMERICAN ARM

The American Arm is the smallest of the three colonial regions. Although the first American outpost was established in 2160 at Barnard's Star, the opening of the American Arm proper dates from the establishment of the outpost at Broward in 2172. This way station became the crossroads for the American and Chinese Arms, with one branch leading through Clarkesstar (outpost established 2187) to the rich colony systems of King and then branching at New Melbourne into the Australian Subarm (to the colonies on Botany Bay and Zeta Herculis) and the American Subarm (to the colonies on Mu Herculis and Ellis). The second principal branch from Broward leads to DM26 12026, the gateway to the Chinese Arm.

The American Arm is a closed branch of stars, with no further 7.7 light year routes remaining out of the cluster. Avalon, a water world, is the sole remaining habitable planet available for further expansion.

Colonies on the American Arm tend to receive more support than settlements on the Chinese Arm but not as much as those found on the French Arm. The oldest colonies here were established over 100 years ago and are old enough to have developed a unique culture, although a derivative of the culture of the mother country. Colonists on this Arm tend to be socially conservative, placing value in self-reliance and a shared distrust of government but they are loyal to their respective nations. Many of these settlers left Earth because of the encroachment of the surveillance society on their private lives and a need to regain some control over their lives.

American colonies in particular enjoy a great deal of central support, at least in the construction and maintenance of their infrastructure. Individuals receive decidedly less and have to work harder to survive and flourish. These colonies, more than those of other countries, were not just established for prestige or to garner resources for the mother country but also to provide a structured outlet for those who cannot deal with the claustrophobic nature of life on Earth.

## WORLDS OF THE AMERICAN ARM

### KING

*UWP:* BD97675-B

### SYSTEM DATA

*Primary Name:* DM+2 3312

*X, Y, Z Coordinates:* -4.0, -24.2, 0.9

### KING COLONIAL DATA

*New Columbia:* UCP: B747645-B NI

*Nationality:* American

*Huntsland:* UCP: C647544-B NI

*Nationality:* Australian

The planet King is one of the most inhospitable worlds ever settled by mankind. Currently home to the American colony of New Columbia and the Australian settlement of Huntsland, this world has a crushing gravity, violent seasonal changes and harsh surface temperatures. Neither nation would have built any kind of extensive base on King if it were not for the wealth of natural resources found here. Currently, King is the source for nearly all of the tantalum used by both nations in their space programs, as well as forming the basis for lucrative trade with allied nations and corporations.

Normal human beings cannot survive in King's crushing gravity and poisonous atmosphere. The first colonists underwent a DNA Modification process, the results of which they passed down to their children. The final effect is thought to be somewhat monstrous but it is effective in surviving their violent homeworld.

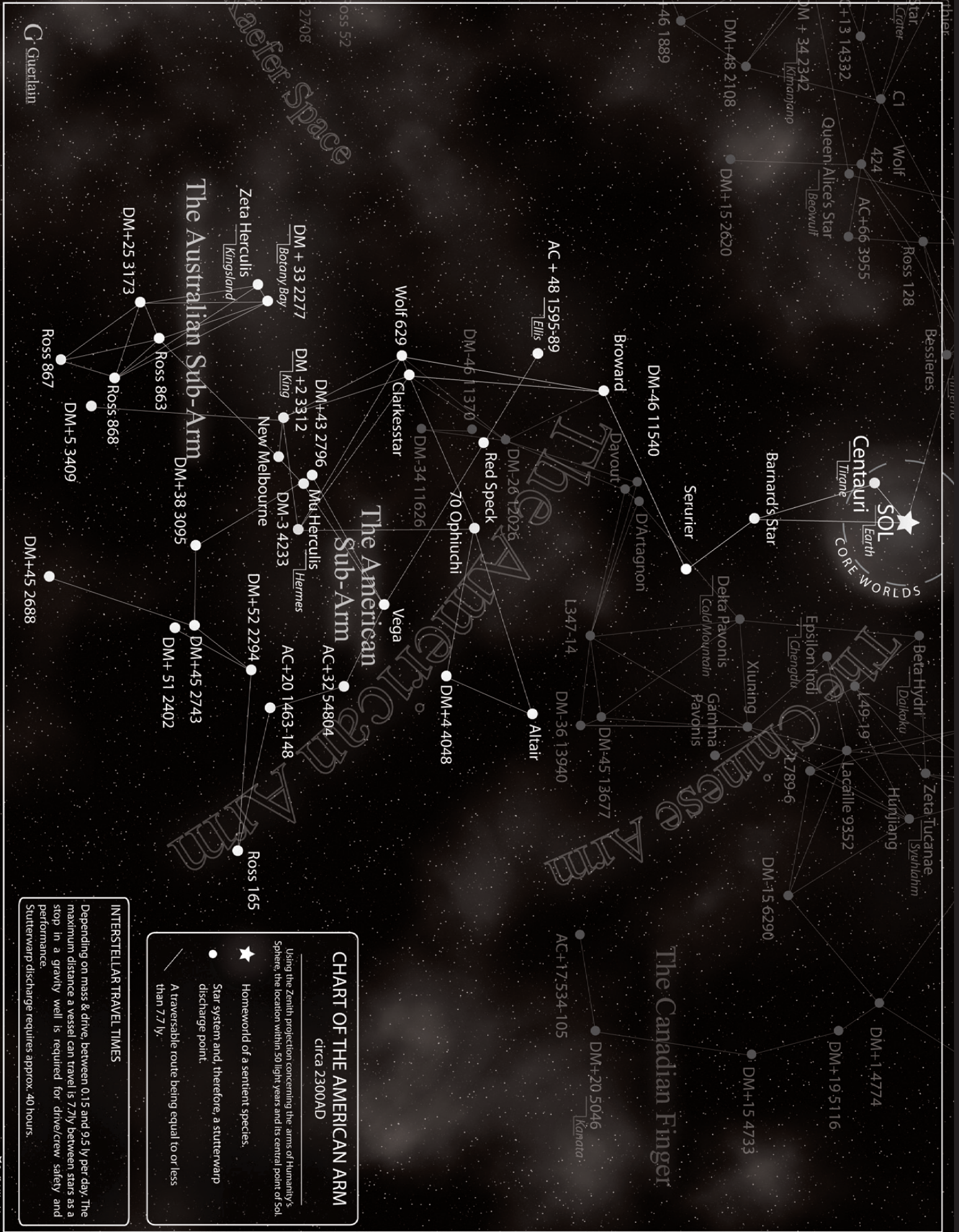

**INTERSTELLAR TRAVEL TIMES**

Depending on mass & drive, between 0.15 and 9.5 ly per day. The maximum distance a vessel can travel is 7.7ly between stars as a stop in a gravity well is required for drive/crew safety and performance. Stutterwarp discharge requires approx. 40 hours.

**CHART OF THE AMERICAN ARM**  
circa 2300AD

- ★ Using the Zenith projection concerning the arms of Humanity's Sphere, the location within 50 light years and its central point of Sol.
- Homeworld of a sentient species.
- Star system and, therefore, a stutterwarp discharge point.
- A traversable route being equal to or less than 7.7 ly.

# King

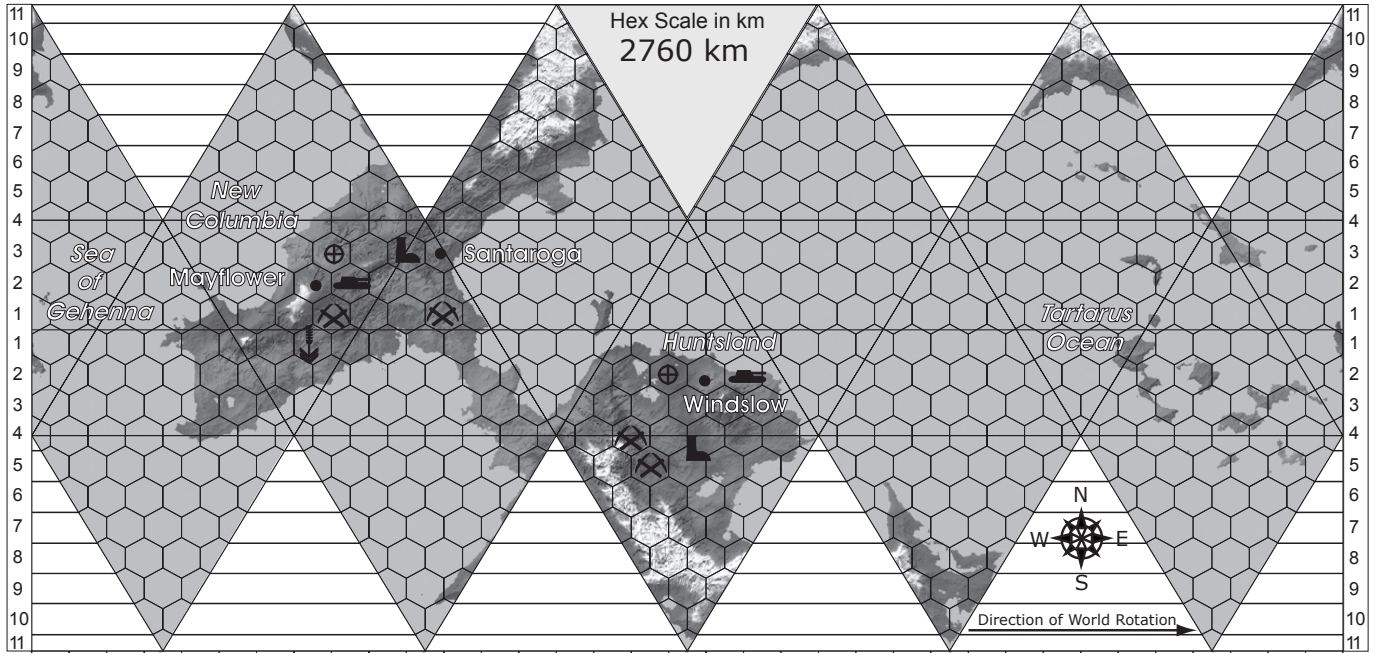

## Legend

- Major City
- ⊕ Spaceport
- ⊗ Mining
- ↓ Farming
- ⌚ Fusion Plant
- ▬ Military Base

*Character Notes:* Long-term residents of King must have either the King DNA modification or else have had surgical/cybernetic augmentation. In addition to the King modification, all residents of King also use the High G row of the Homeworld gravity table (page 89).

## HERMES

UWP: B668644-A

### SYSTEM DATA

Primary Name: Mu Herculis A

X, Y, Z Coordinates: -1.6, -23.3, 12.2

### HERMES COLONIAL DATA

UCP: B757644-A Ri In 6 0

Colony Name: Hermes

Nationality: American

With an average surface temperature of  $-33.6^{\circ}$  Centigrade, Hermes is one of the coldest inhabitable planets in human space.

**White Wing:** One of the more dangerous flying carnivores on Hermes, the White Wing can mass as much as 250 kilograms and vaguely resemble furry white pterodactyls. Hunting white wings is a popular tourist attraction although, on occasion, the hunters can become the hunted.

During the long, slow winters, the temperatures at the planet's poles can get cold enough to freeze out dry ice and are quickly fatal without advanced thermal protection. The equatorial sea, however, is ice-free in summer. The small continent bearing the American colony is similar to Alaska in climate and geography.

Originally settled as an agricultural colony, the cool temperatures made it less than successful. It is now home to the largest industrial concerns in the entire American Arm, supplying heavy equipment to most of the American and Australian colonies. Foremost among these is the Mule Corporation, a manufacturer of heavy equipment.

*Character Modifications:* Residents of Hermes usually have the Cold World DNA modification, although some choose the Fast Reaction modification instead. Hermes is a Low Gravity world.

## ELLIS

UWP: B861644-9 Ag, Ri

### SYSTEM DATA

Primary Name: AC + 48 1595-89

X, Y, Z Coordinates: -6.5, -14.3, 17.6

### COLONIAL DATA

UCP: B975646-A Ag, Ri 5 0

Colony Name: Ellis

Nationality: American

# Hermes

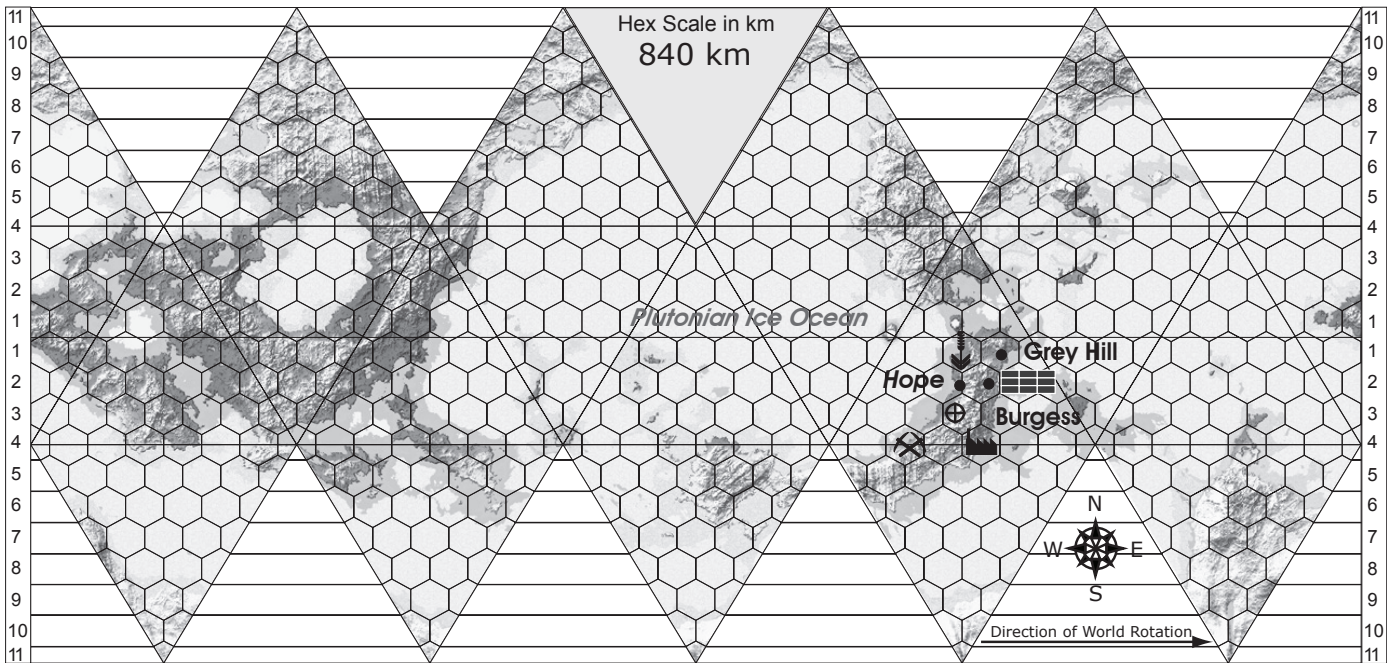

# Ellis

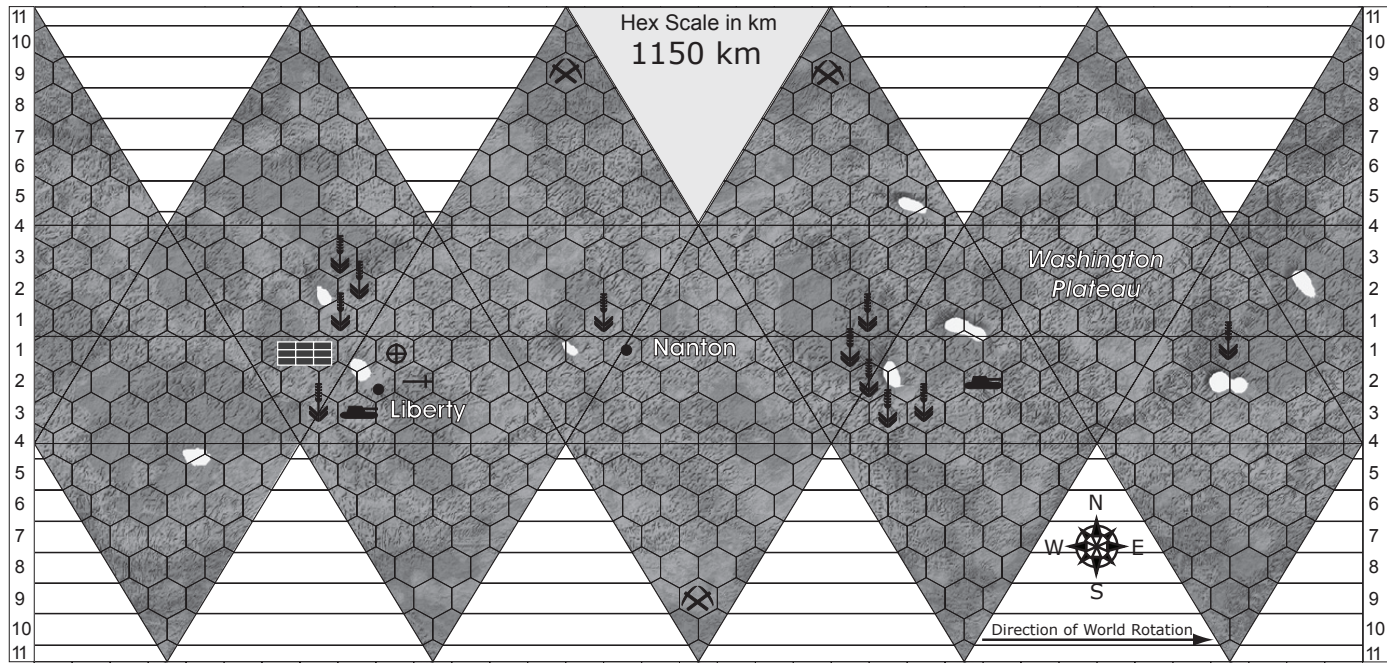

## Legend

- Major City
- ⊕ Spaceport
- + Catapult

- ⚡ Mining
- ↓ Farming
- 🏠 Military Base

- ⚡ Fusion Plant
- ☰ Solar Power Rectenna
- 🏭 Heavy Industry

There are few worlds as important to the daily survival of the American Arm colonies as Ellis. Once a fairly Earth-like world, Ellis has been in a constant spiral toward ecological ruin for thousands of years. The bold colonists who have chosen to settle there, however, are engaged in an effort to halt the ecological decline and restore the planet to some semblance of its former state. As the 24th Century dawns on humanity, this once barren world is now the pride of the United States, producing a great amount of food which is shipped across the entire American Arm.

Only seven percent of the surface of Ellis is covered with water, making most of the planet a dry wasteland. The efforts of colonists, however, are increasing the productivity of the lands around these scattered lake regions. Various efforts are underway to irrigate the wastelands and each year additional farmlands are opened up to homesteaders. There is a limit to how far these farmlands can expand, however, due to the extremely limited amount of water available.

*Character Modifications:* Most colonists of Ellis have received the Dry World DNA modification. Otherwise, Ellis is a Normal Gravity world.

### **BOTANY BAY**

*UWP:* C769664-9 Ri Ag 1 0

### **SYSTEM DATA**

Primary Name: DM+33 2777

X, Y, Z Coordinates: -8.6, -24.7, 17.3

Botany Bay presented the Australians with their first opportunity to colonise an entire world for their own purposes. Agreements with their American allies at the time allowed them exclusive rights to populate and explore the entire DM+33 2777 system. Naturally, their first garden world was named Botany Bay in a unanimous vote of the Australian legislature. The world is quite pleasant, with large numbers of airborne insects being the only local wildlife that cause any problems.

### **BOTANY BAY COLONY DATA**

*UCP:* C557664-9 1 0

*Colony Name:* Darwin Island

*Nationality:* Australian

The shallow, muddy seas of the planet are the source of much of the raw material used in the light industry, in particular paper and lumber, forming the backbone of Botany Bay's economy. The colony itself is concentrated on the shoreline of the largest island and spills off the coast for several kilometres becoming a merman colony as well.

### **NEW AMERICA**

In the years prior to the Twilight War, New America was an ultranationalist, ultra-right-wing organisation that included many survivalists, militia members and white supremacists. In the years following the war, they made a determined effort to create their vision of America and embroiled both the military and civilian governments of the time in a decades-long civil war. The movement was eventually defeated and driven underground but has started to resurface on several American colony worlds, in particular Ellis.

## Botany Bay

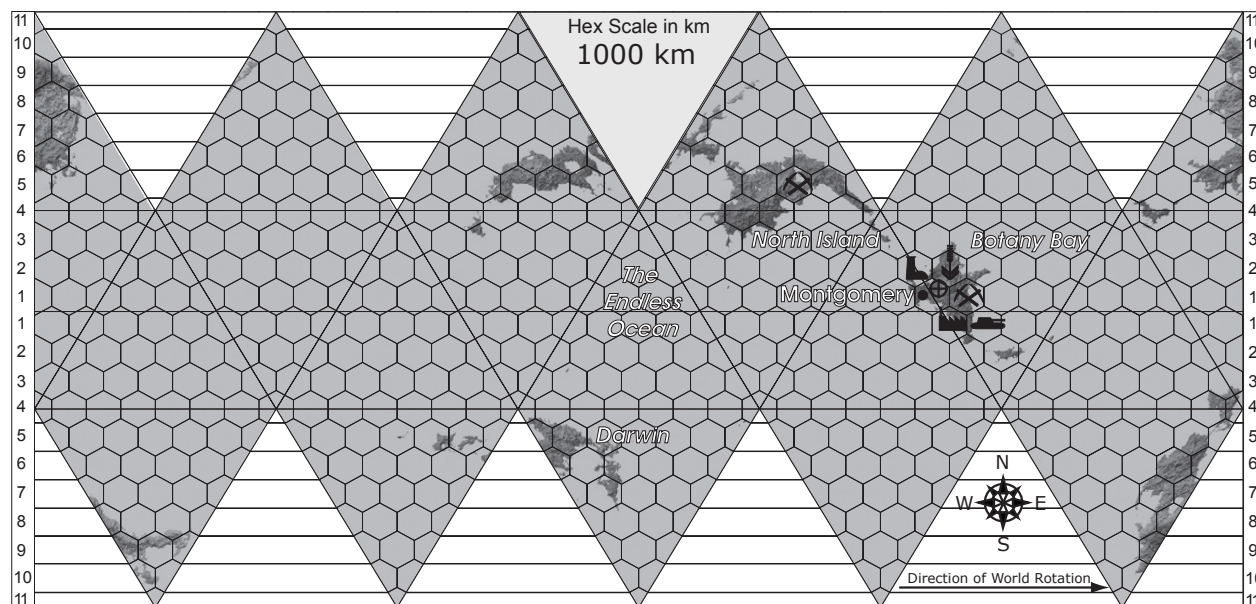



*Character Notes:* While most colonists on Botany Bay just have the Core Colonist DNA Modification, some elect to go with the Merman modification, given the importance of ocean industries to the world.

Botany Bay is a Normal Gravity World.

## **KINGSLAND**

*UWP:* D865545-8 4 0

### **SYSTEM DATA**

*Primary Name:* Zeta Herculis A

*X, Y, Z Coordinates:* -9.2, -25.1, 16.4

Kingsland is officially classified as a glacier world. However, since there is considerably less water available on the planet, the glaciers only cover the northern and southern sixths of the planet. Also, since Kingsland has almost no axial tilt, there is an area around the equator that is not only ice free but has lakes of freestanding water and its own weather patterns. These areas have spawned life and are quite hospitable. However, much of the surface of Kingsland is unusable and the geography is split into three distinct types – glacier, tundra and equatorial. The vast majority of the settlements are in the equatorial zone, with only a few hardy souls venturing into the tundra regions. The glacier regions are almost entirely unexplored, save for orbital photogrammetry.

### **KINGSLAND COLONY DATA**

*UCP:* D526545-8 Ag Lo 5 0

*Nationality:* Australian

Some mining has begun on Kingsland, with marginal success. There are deposits of iron, bauxite and tantalum on the planet. Eventually it is hoped that Kingsland will be able to support mining operations on Kingsland Prime as well but such efforts are confined merely to a couple of demonstration sites at this time.

*Character Notes:* Kingsland colonists receive the standard Colonist Core DNA Modification. Some may also have the Cold World modification. Kingsland has Normal Gravity.

## **EXPLORATORY WORLDS**

Due to the closed nature of the American Arm, there are few worlds left for further colonial expansion. However, recent activity and the end of one of the closed branches may herald new opportunities.

## **AVALON**

*UWP:* X76A310-8

### **SYSTEM DATA**

*Primary Name:* DM-34 11626 A

*X, Y, Z Coordinates:* -3.7, -18.8, -13.4

This world is the last remaining hospitable world on the American Arm and a likely target for colonisation in the near future. With its shallow seas and archipelagos, Avalon's ecology is fragmented, with each island chain having its own unique micro-ecology.

Avalon is a world of small islands and archipelagos, all heavily shrouded in cloud and fog. From space, Avalon is a mystery, with few breaks in the cloud cover. The depth of the oceans is quite unusual. Most of the seas are very shallow, less than 300 metres. However, at the north and south poles, the oceans are almost three times deeper than elsewhere on the planet. It is theorised that at one point in time the water level was much lower, giving the planet wide continents. Mechanisms for the increase in depth of the oceans are all speculative. The common theory runs that the world was once much colder, with extensive polar ice caps and some sort of climate shift warmed the world up, thus melting the ice caps.

*Character Notes:* Avalon cannot be a character homeworld. It is a Low gravity World.

## **FRENCH ARM**

The French Arm vies with the Chinese Arm as the most developed grouping of colony worlds. The Arm contains a total of 12 colony worlds, colonised mainly by France, Britain, Germany and Azania but with settlements by many other nations as well. Most of the worlds have colonies from multiple nations.

The long-settled nature of many of these worlds is a source of considerable acrimony and even conflict, between those worlds and the nations that colonised them. Many of these colonies are growing increasingly disenchanted with their role as adjuncts of national policy and are clamouring for increased home rule or even independence. The new nation of Elysia is eager to foment unrest among its former colonial brethren and the French government is tightening security all across the Arm.

The recent war of German Reunification on Earth has created tension between formerly peaceable neighbours on many worlds. There is also dissension from many of the former Bavarian colonies, the populations of which are uncertain about submitting to the rule of a new, reunited Germany, in which Bavaria plays a subordinate role.

Of the three arms, the French Arm is the most open, with vast numbers of stars awaiting exploration and possible colonisation. Several expeditions have ventured past Hochbaden into the Wolf cluster and there are fortunes to be made. Exploration beyond settled systems has brought contact with the Pentapods and the Kaefers; the possibility of new contacts is real and immediate. However, these contacts are viewed as possibilities for profit, knowledge or both and are eagerly sought by the governments and corporations moving out into unexplored space.

# Kingsland

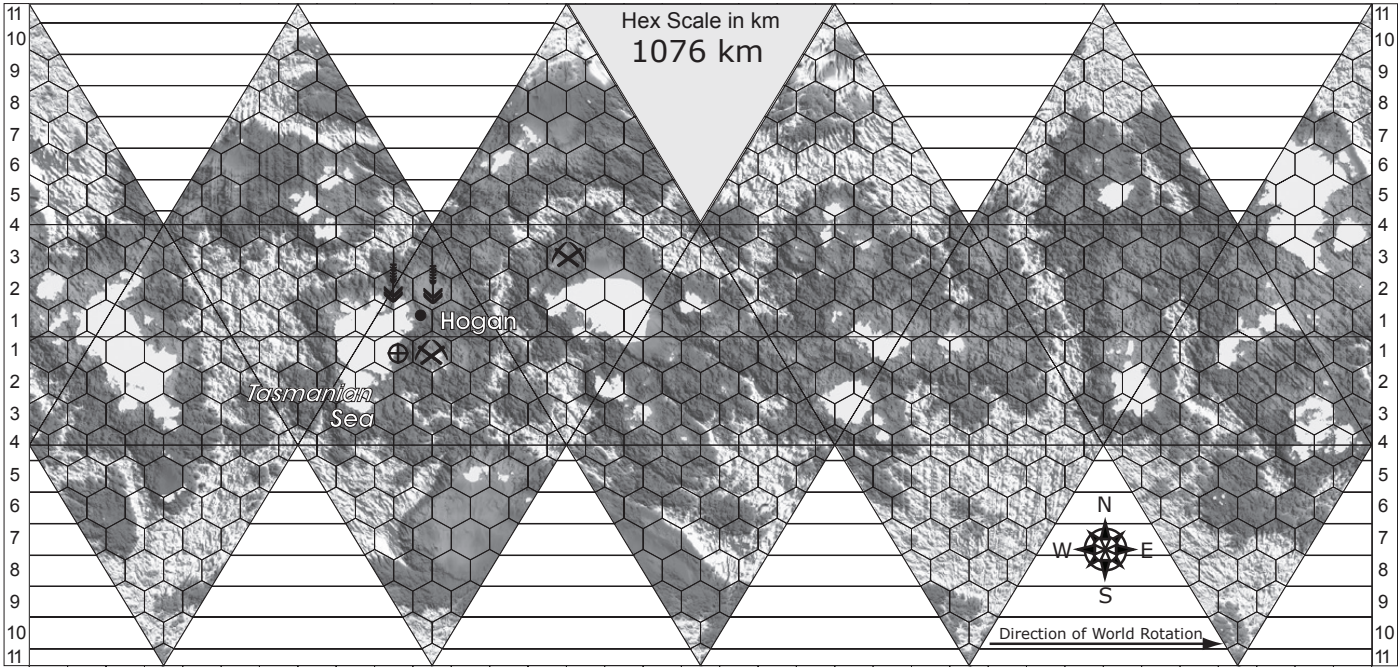

# Avalon

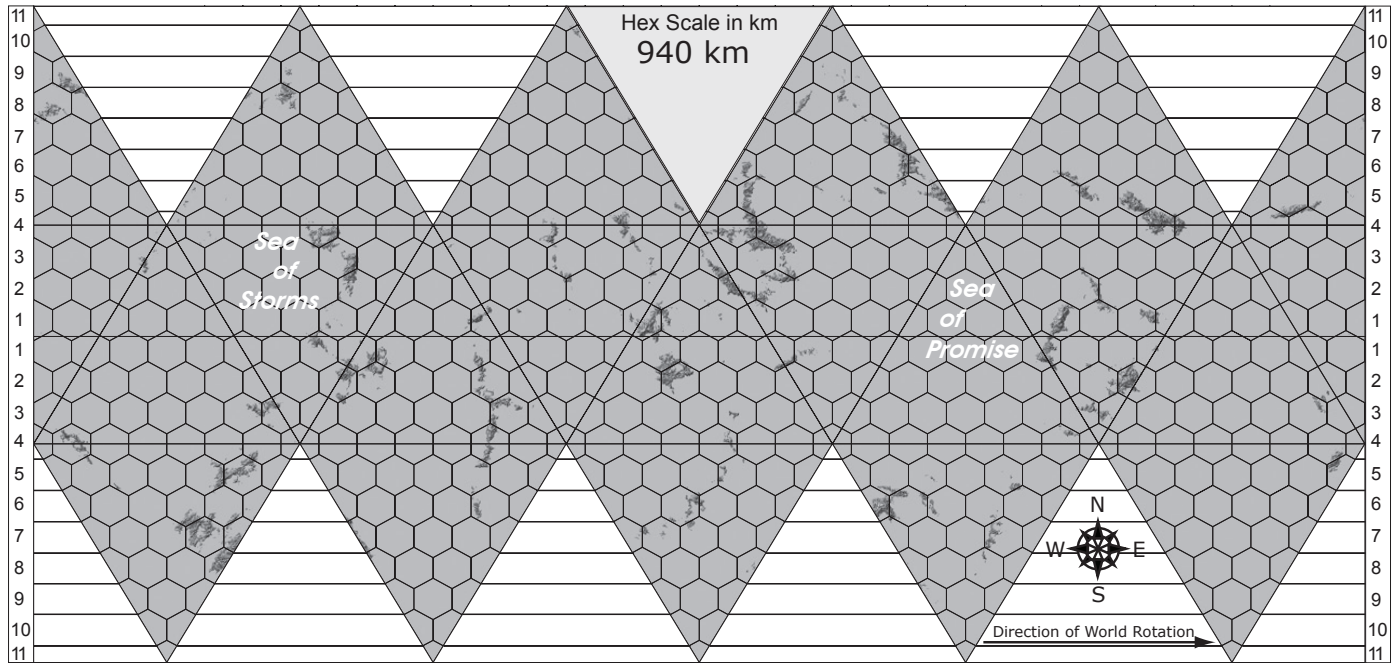

## Legend

- Major City
- ⊕ Spaceport
- Catapult

- ⚒ Mining
- ↓ Farming
- 🏰 Military Base

- ⚡ Fusion Plant
- ☀ Solar Power Rectenna
- 🏭 Heavy Industry

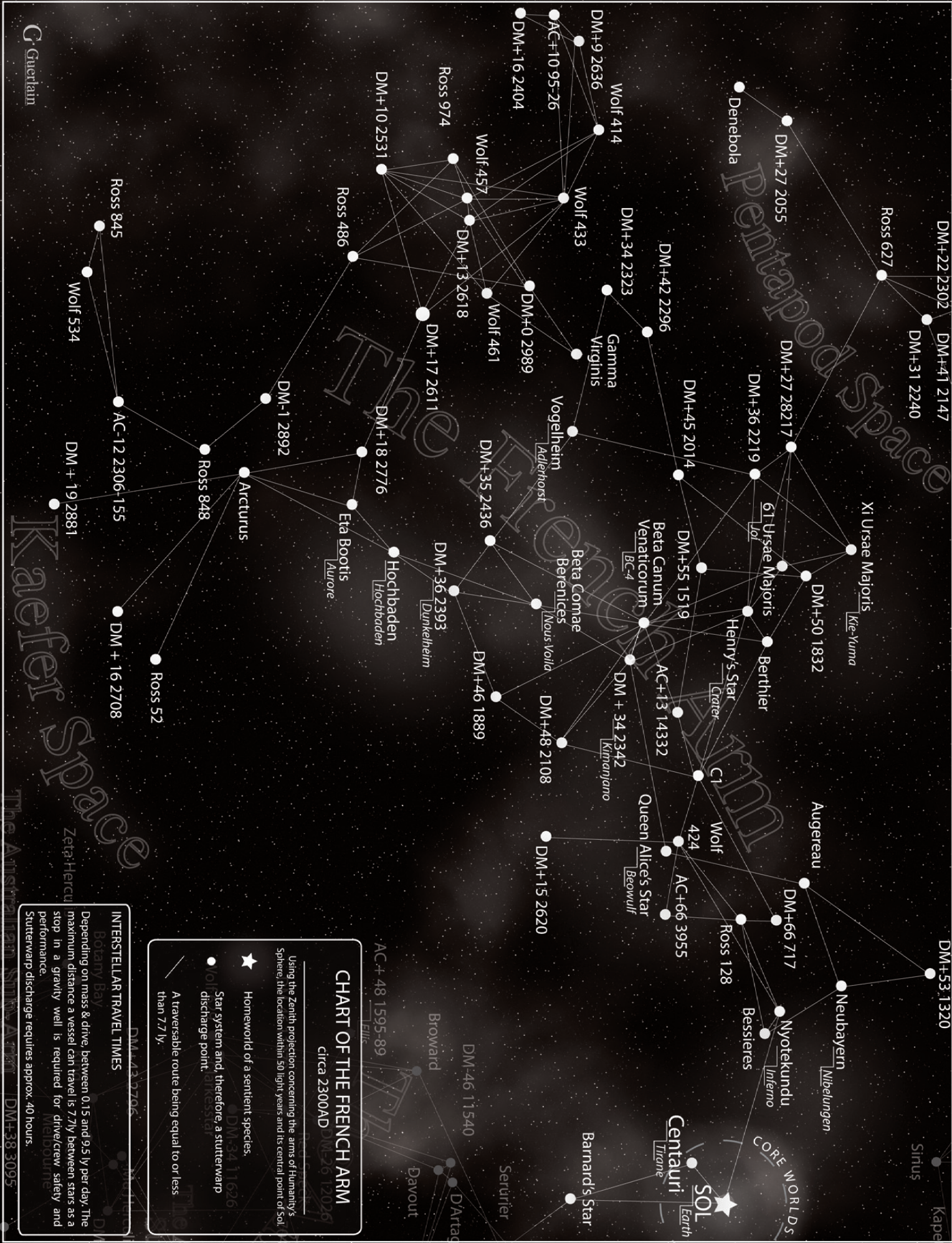

Not far past Hochbaden, however, lies the besieged system of Aurore, with the mysterious invaders coming from beyond Arcturus. While this war gets scant attention in the Core, human military leaders are growing increasingly anxious over the prospect of fighting a war with a civilisation that may well be more advanced than theirs.

## WORLDS OF THE FRENCH ARM

### NIBELUNGEN

UWP: B463844-B

#### SYSTEM DATA

Primary Name: Neubayern

X, Y, Z Coordinates: -8.4, 4.4, 11.1

Nibelungen is a tidally-locked world, with three distinct climatic zones. The most habitable regions of the planet are in the 'Twilight' region between the Hotside and the Coldsides. Nibelungen boasts a well-developed local biosphere with significant influxes of Terran species in the settled areas. Vitamin supplements are generally not required.

#### COLONY DATA

UCP: B864747-B Ri 9 0

Colony Name: Nibelungen

Nationality: German

Nibelungen, the only habitable world in the system, is the site of an extensive colonisation program, one of the most successful ever attempted, especially given the difficulties of colonising a tidally-locked world. Farms and tantalum mines are the world's most important resources, though they have recently begun to branch out into light industrial products, directly competing with the extensive industrial facilities of the Bessieres system.

### BEOWULF

UWP: B867775-B

#### SYSTEM DATA

Primary Name: Queen Alice's Star (DM+46 1797)

X, Y, Z Coordinates: -13.7, -2.1, 14.3

The climate of Beowulf is somewhat harsher and the terrain generally much more rugged than comparable Terran regions. Wildlife tends to be quite dangerous and shows no fear of humans. The various dracoforms are wily and vicious; their low-slung, multi-limbed bodies have little trouble getting around in Beowulf's rugged terrain. Also of note, Beowulf's 'day' is half a local year long and the seasons last less than two weeks each.

#### WATCH THE SKIES!

The most fearsome predator on Beowulf is the so-called Dragon-Bat, a huge nocturnal flier that is capable of killing an adult or carrying off a child. It is part of a large family of pseudo-reptiles called dracoforms for their resemblance to the dragons of Earth legends. Many of them can even spit venom or digestive acids.

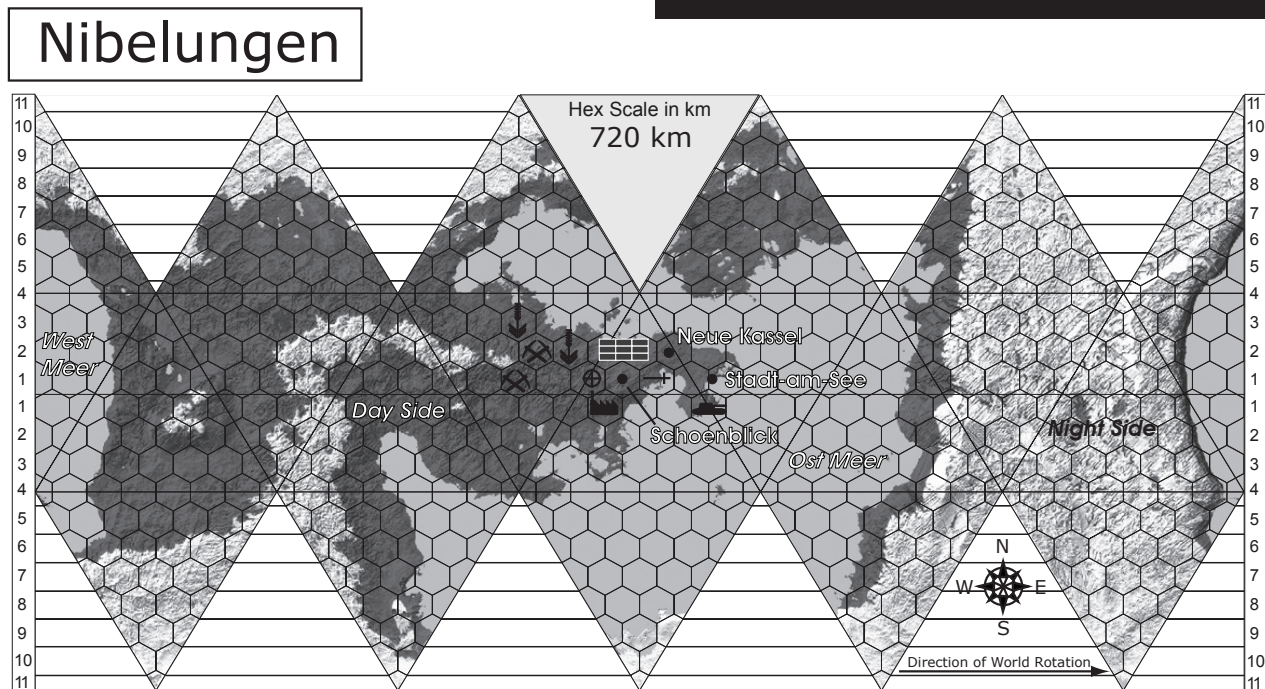

#### Legend

- Major City
- ⊕ Spaceport
- Catapult

- ⚒ Mining
- ⚒ Farming
- 🚀 Military Base

- ⌚ Fusion Plant
- 📶 Solar Power Rectenna
- 🏭 Heavy Industry

### THE BRITISH COLONY DATA

UCP: B747746 Ri Ag 2 0

Colony Name: Alicia

Nationality: British

British colonists were first to settle on Beowulf and they quite naturally chose to develop the best of the two continents when they arrived. They named the continent Alicia, in honour of the Queen at that time; the first large city (and capital until 2279 AD.) was Aliceport. Later a new capital, named Heorot after the grand hall where Beowulf battled Grendel, was built to house the colonial government.

### THE FRENCH COLONY DATA

UCP: B736746-B Ri Ag 1 0

Colony Name: Europe Neuve

Nationality: French

The French colonisation effort on Beowulf was far less intensive than that of the British on Alicia, more so because of the region they were forced to settle in, the smaller continent they named Europe Neuve, was of far less exploitable value. Like the British, the French are mostly found along the coast of the continent; the interior is untamed and largely unexplored. A large scientific facility has been established in the rugged hinterlands to investigate a number of interesting life forms and natural phenomena.

**Character Notes:** Colonists on Beowulf often take the Fast Reaction DNA modification, due to the constant threat of the various dracoforms.

Beowulf has Normal Gravity.

### KIMANJANO

UWP: B778676-B

### SYSTEM DATA

Primary Name: Kimanjano

X, Y, Z Coordinates: -20.8, -3.6, 14.3

Though Kimanjano has an oxygen-nitrogen atmosphere, it possesses no life as it is normally defined. The first expeditions discovered this anomaly and subsequent surveys found the source of the oxygen. The oceans of Kimanjano are an organic soup of chemicals, including many that are commercially valuable. Some of these pre-biotic materials react with the seawater to produce oxygen, while others utilise some of the oxygen in their chemical processes. Although there is no evidence of life, there are things that could almost pass as life-forms, free-floating globs of amino acids and organic chemicals. In addition to the near-life-forms, the oceans of Kimanjano hold a fortune in chemicals, capable of producing everything from construction synthetics to fine perfumes, with a variety of medical compounds thrown in for good measure.

### French Colony Colonial Data

UCP: B626667-C Na, Po 6 0

Colony Name: Fromme

Nationality: French

The carefully-planned French colony of Fromme was created as a port facility to service the platforms that harvest the biochemical wealth of this unusual world. The catapult makes delivery of cargo and materials into orbit easy and economical. Fromme includes seaport facilities, such as ship construction, maintenance yards, warehouses and L'Usine (The Works), an industrial processing facility the size of a small city.

## Beowulf

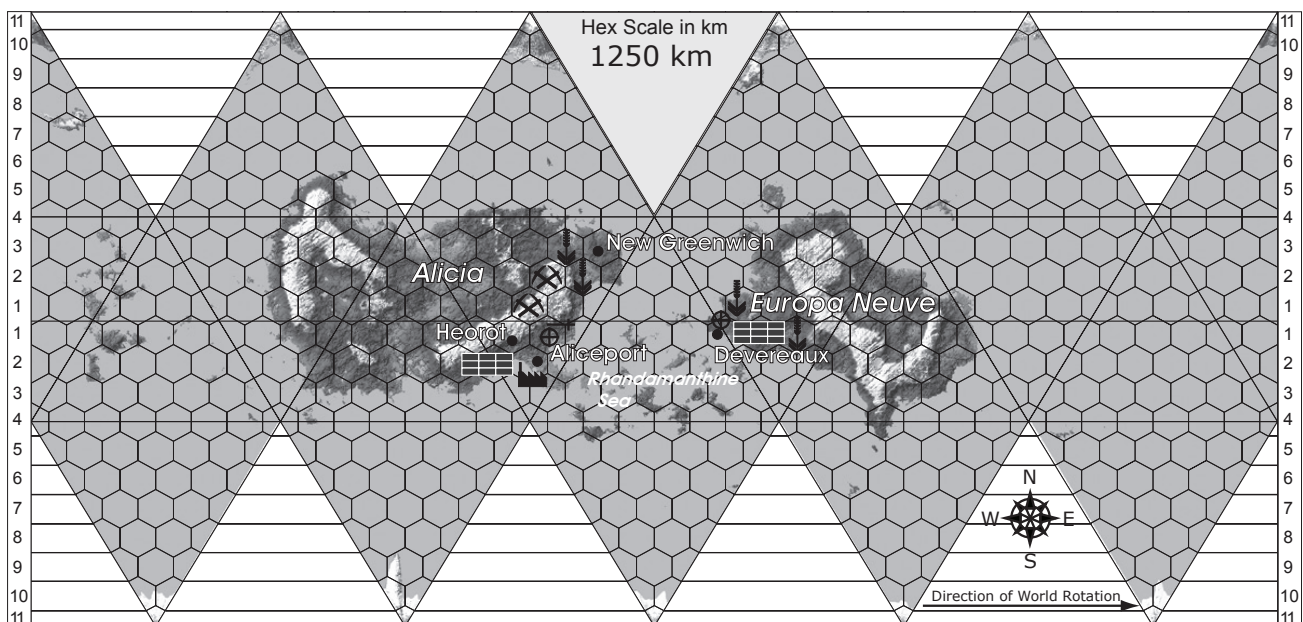

# Kimanjano

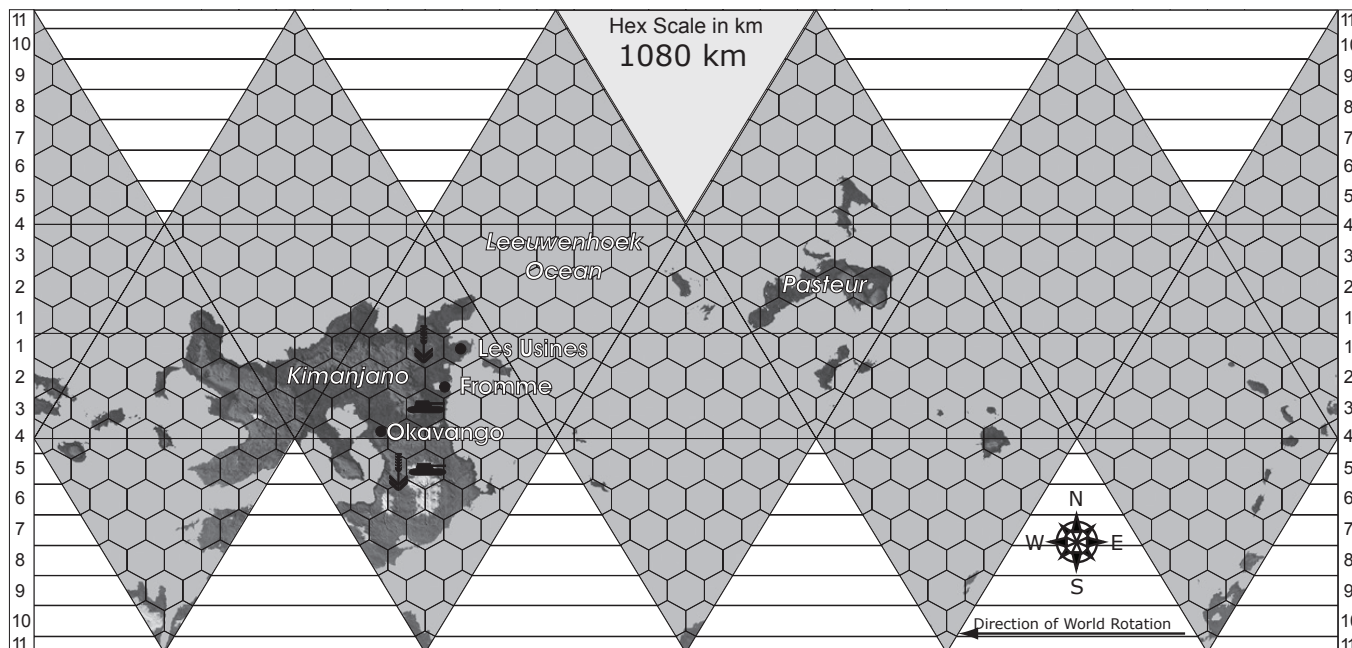

## Legend

- Major City
- ⊕ Spaceport
- Catapult
- ⚡ Mining
- ⬇ Farming
- 🏠 Military Base
- ⏏ Fusion Plant
- ☰ Solar Power Rectenna
- 🏭 Heavy Industry

## AZANIAN COLONY DATA

UCP: C673544-11 9 0  
 Colony Name: Okavango  
 Nationality: Azanian

In contrast to the French colony site, the Azanian site was a study in inspired anarchy. Very much the latecomers, the Azanians only settled in 2280. Their colony consists of standardised, commercially purchased modular units. These have been set down with apparently no order, scattered over a 20-square-mile region roughly surrounding a small bay. There is a landing strip just beside the bay. While the Azanians likewise exploit the rich pre-biotic soup of the planet, they also grow a significant portion of the world's food.

*Character Notes:* Colonists on Kimanjano typically go with the Standard Colonist DNA modification. However, many of them also get a symbiote that filters out some of the pseudo-biological components of the atmosphere.

Kimanjano has Normal Gravity.

## KIE-YUMA

UWP: BC97628-C

## SYSTEM DATA

Primary Name: Xi Ursae Majoris A  
 X, Y, Z Coordinates: -25.0, 4.9, 15.7

The atmosphere of Kie-Yuma is denser than that of Earth and often appears 'hazy' or 'murky' to the colonists on the surface. With an oxygen content well within human tolerances, Kie-Yuma's air is quite breathable (although a bit 'thick' and 'heavy' to breathe for those used to an Earth-normal pressure) except for a relatively small fraction of unsavoury gases and biological components present. Most of the world's animal life lives in the seas, while the land is home only to plants and primitive insect-like creatures.

## COLONIAL DATA

UCP: B679628-C Po Na 1 0  
 Colony Name: Kie-Yuma  
 Nationality: Corporate (Trilon)

---

## THE CIRCUS

The Amazing Interstellar Circus consists of three travelling shows, each based in one of the Arms of exploration. The Circus visits a new world each month and stays for about a week, providing shows and entertainment for the entire planet. Costs of the Circus are partly subsidised by the major governments and sponsoring corporations. There are rumours of something dark behind the Circus, although the story varies from Arm-to-Arm. In the Chinese Arm these stories are linked to ProVolution, in the American Arm to smugglers and slavers and in the French Arm either to Pentapods or Colonial Secessionists.

---

As a corporate colony, Kie-Yuma is unique in human space. First settled in 2260, Trilon has continued to expand the colony, making it the focus of their efforts on the French Arm. With the extensive orbital facilities, it is likely that Trilon will shift production for the colonial markets from Earth to Kie-yuma. All colonists on the surface of the world live in habitats, due to the trace poisons and plant spores that cause strong histamine reactions in most people.

The year 2261 saw the first of the atmospheric processors installed and construction started on the other three stations. Within five years, all four were completed and brought on-line. NARL had previously raised concerns about the effect of the atmosphere processors on the course of evolution on the planet but Trilon scientists dismissed the concerns of the environmental group.

*Facilities:* Due to the unsavoury elements in the planet's atmosphere, all of Kie-Yuma's colonists live and work in sealed habitats of some form. Air and water are pumped in from the planet's surface, although both must pass through extensive filtering units before being utilised by humans. The sealed habitats also serve to protect the colony's facilities from the severe thunderstorms that often develop on Kie-Yuma's surface.

*Character Notes:* Colonists on Kie-yuma often take the Colonist Core package, although many executives opt to not have any modifications at all, if they expect to be posted back to Earth. This has created a sort of two-tiered society, with the genetically-modified colonists considered second class.

Kie Yuma has Normal Gravity.

## BETA CANUM VENATICORUM

UWP: A766775-B

### SYSTEM DATA

*Primary Name:* Beta Canum Venaticorum

*X, Y, Z Coordinates:* -22.2, -3.1, 19.8

Beta Canum Venaticorum is a pleasant, earth-like world, despite the indigestibility of the local lifeforms, both plant and animal. However, since none of it is actively poisonous, it can be eaten simply to enjoy the flavours and textures, so long as care is taken to eat sufficient 'normal' food.

Beta Canum's abundant life utilises right-handed amino acids, rather than the terrestrial left-handed amino acids. Native life forms have no nutritional value for Terran life forms and vice-versa. However, transplanted Terran life does very well, as there are no pests to consume it.

The only exception to that rule was the Beta Grain Blight, a local fungal infestation that attacked human crops for two years before being brought under control by a Pentapod-engineered defence. Debate continues to this day as to the cause of the Blight, which some blame on the Pentapods.

Agriculture is still Beta Canum's most valuable industry, although tourism is regaining its importance as well.

## COLONIAL DATA

The Beta Canum Venaticorum system was first visited by human starships in 2181. These were French starships exploring under the auspices of the European Space Agency. From 2182 until 2202, detailed surveys of the system were performed by a research team from Das Astronomischen Rechen-Institut, concentrating on the garden world. The initial surveyors established their base of operations on the northernmost tip of Beta Canum's southern continent, now home to the largely abandoned city of Adrian.

Three nations established colonies on Beta Canum: France, Britain and Bavaria (now Germany), each laying claim to one of the major continents. The southern continent was held jointly as an ESA territory.

## FRENCH COLONY

UCP: A976744-C Ri Hi 3 0

*Colony Name:* French Continent

*Nationality:* France

The French colony on Beta Canum is a very pleasant place, with a patchwork of farms around every city and industrial regions kept far from the cities. This colony is the agricultural mainstay of the entire French Arm, using the beanstalk to cheaply export foodstuffs to many worlds.

*The Pentapod Enclave:* In 2261, the Pentapods made a request to build an enclave on the French Continent's western shore. That request was quickly approved by all ESA governments, in the desire to establish stronger ties with this strange race of bioengineers. Pentapods, being amphibians, are equally at home in all three environments encompassed by the enclave: underwater, dry

---

## THE BEANSTALK

The first operational Beanstalk in human space became operational on Beta Canum in 2291. Although marred by tragedy in 2293, when 40 capsules, including some passenger capsules, fell off, it has contributed greatly to the success of all the colonies, in particular the French colony.

---

# Kie-Yuma

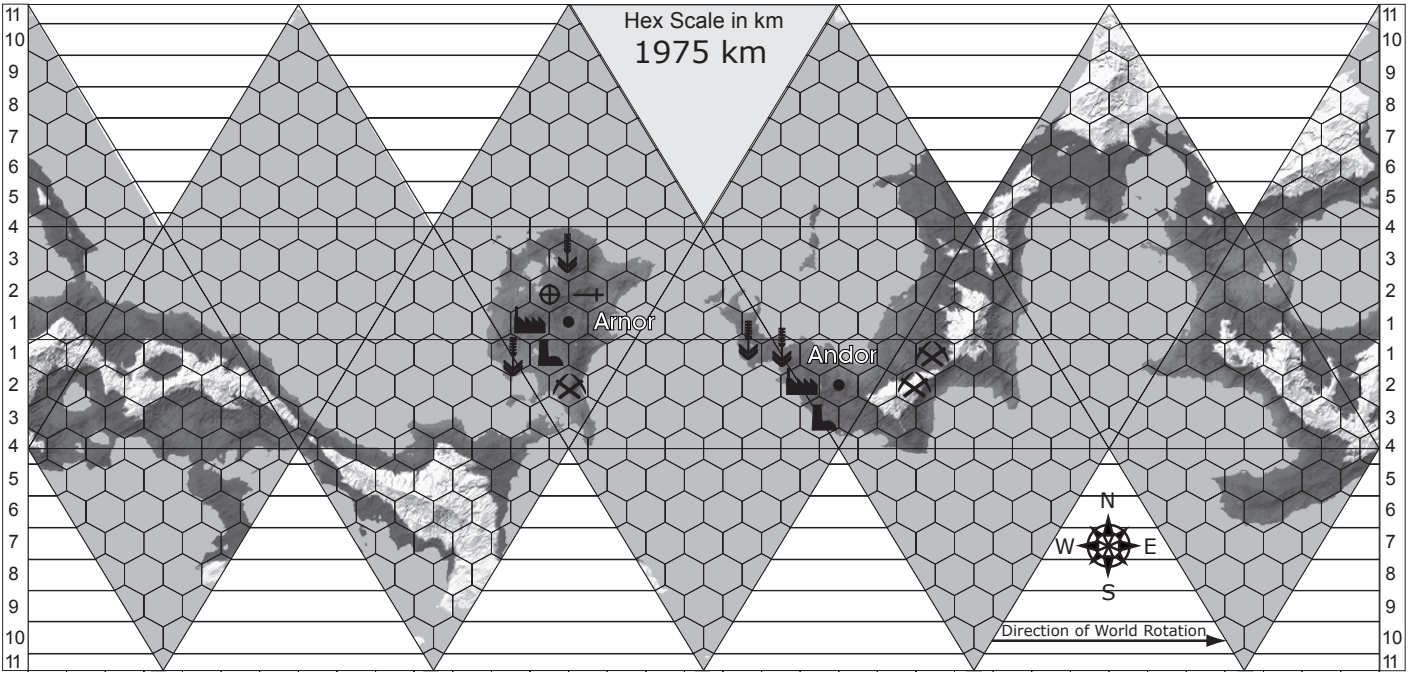

# Beta Canum

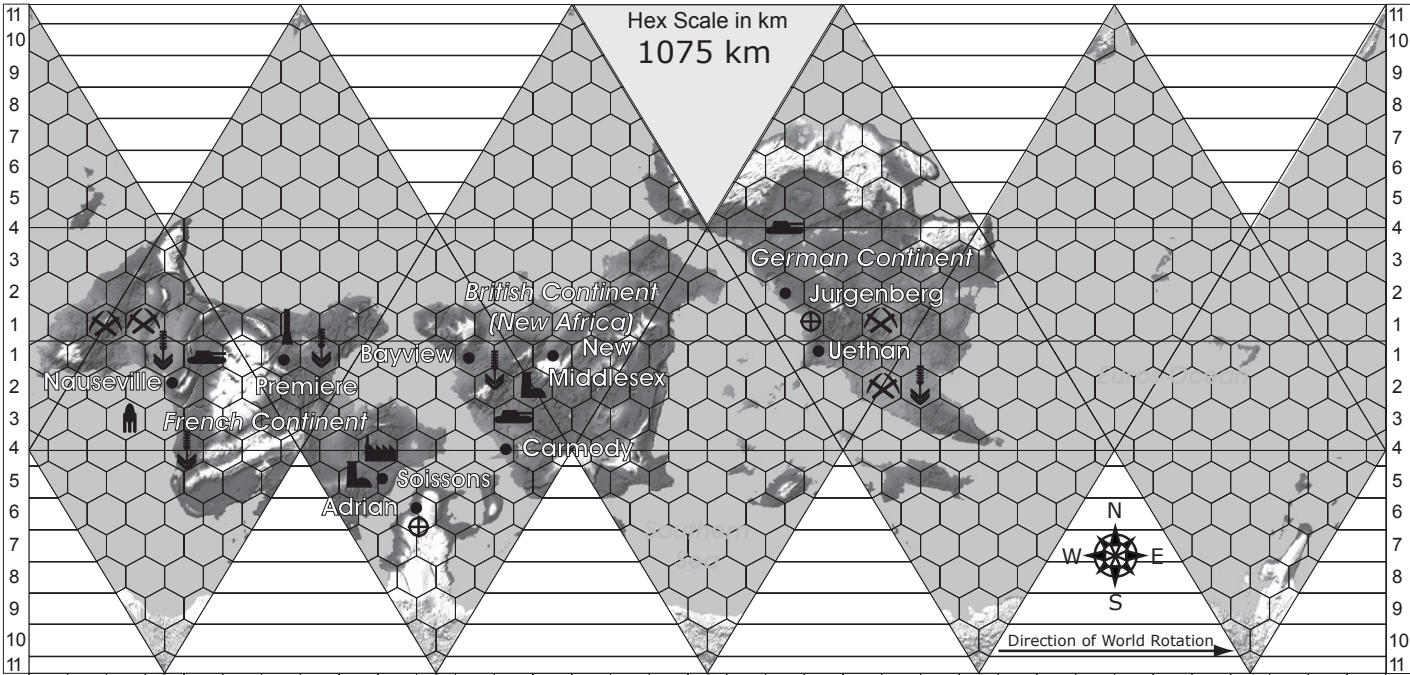

## Legend

- Major City
- ⊕ Spaceport
- + Catapult
- ⌄ Beanstalk
- ⚒ Mining
- 🌾 Farming
- 🏠 Military Base
- 👤 Pentapod Enclave
- ⌄ Fusion Plant
- ☰ Solar Power Rectenna
- 🏭 Heavy Industry



and mixed. Humans gain greater respect from the Pentapods by braving the wet rooms when dealing with the aliens.

### GERMAN COLONY

UCP: C857747-B Ri Hi 1 0

Colony Name: German (Bavarian) Continent

Nationality: German

Although largely equatorial, the German colony largely lies at a higher altitude than New Africa and so is cooler and more temperate. Mining is the principal industry of this colony, with enough agriculture to support the primary needs of the population, however, some products need to be imported from other colonies. Relations with the French colony are strained in the aftermath of the War of German Reunification.

### BRITISH COLONY

UCP: B887745-B Ri Hi 1 0

Colony Name: New Africa

Nationality: British

New Africa is still instrumental in shipping goods back and forth across the continent and on to markets in the German and French colonies. Tourism is the continent's most important industry, with agriculture a distant second. Lives here are pleasant and largely rural. New Africa straddles the equator and is the largest and most productive colony on the platform.

*Character Notes:* Colonists on Beta Canum usually receive the Core Colonist package.

It has Normal Gravity.

### JOI

UWP: C965675-9

### SYSTEM DATA

Primary Name: 61 Ursae Majoris

X, Y, Z Coordinates: -24.4, 2.2, 16.7

Joi, 61 Ursae Majoris III, is the single human-habitable planet in the star system. It is one of the most Earthlike of the colony planets settled to date. Native crops are considered suitable for human consumption but the colonists have found that the relatively less advanced ecosphere of Joi simply cannot compete with plants introduced from off-world. Although ecologists have issued dire warnings, there are two colonies – Azania's and Japan's – which have mounted large-scale importation of such crop seeds. Plans to do the same in Elysia were another factor for their break with the French government.

### COLONIAL DATA

Five different nations planted colonies on Joi. Each one has its own unique characteristics and each a distinct local identity that has led, on more than one occasion, to serious disputes among them.

# Joi

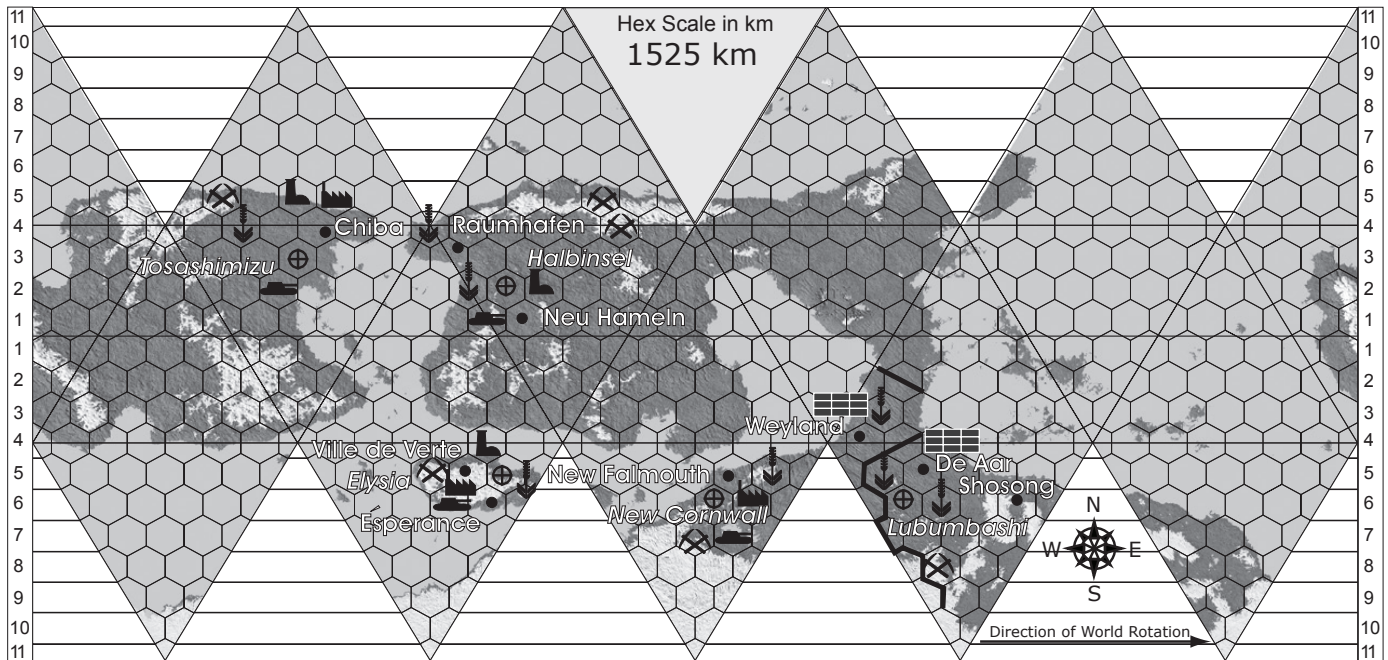

### Legend

- Major City
- ⊕ Spaceport
- Catapult
- ⚡ Mining
- 🌾 Farming
- 🏠 Military Base
- 🏭 Fusion Plant
- ☀️ Solar Power Rectenna
- 🏭 Heavy Industry

### **THE GERMAN COLONY**

*UCP:* C665668-9

*Colony Name:* Landeplatz-Friedrich der Grosse (Halbinsel)

*Nationality:* German

The French may have been the first to survey Joi but the Bavarians were the first to actually put in a colony.

The colonial government operates with a typically German efficiency. There is very little input from the colonists themselves; they answer to an Earth-appointed governor who has some very large – indeed sometimes totally impractical – quotas and schedules to meet. Although there has been grumbling about that, the colonists are also eager to show their support for the new unified German government.

### **THE EX-FRENCH COLONY**

*UCP:* D556645-9 Ag Ri 2 0

*Colony Name:* Elysia

*Nationality:* Independent

France arrived on Joi less than a decade after the Germans, settling on the large island (or small continent) of Elysia. In 2285, long-standing grievances between the colonists and the French government erupted into violence. An environmental demonstration turned ugly when a young French lieutenant panicked and ordered his troops to open fire. The casualties were light but the event incited the population into rebellion. Six years later, the rebels were in charge and France was in retreat.

To outsiders, Elysia always seems on the verge of collapse and indeed it still is not completely stable. This impression is certainly encouraged by French officials and news media, to the extent that few news agencies will report anything other than the French version of events in their former colony.

### **THE BRITISH COLONY**

*UCP:* C6786665-A Ag Ri 3 0

*Colony Name:* New Cornwall

*Nationality:* British

New Cornwall is the most advanced of the colonies on Joi. Britain committed to a slow, steady build up of this colony, through a series of carefully-planned stages. It remained neutral during the Elysian War of Independence, although Britain is a putative ally of France.

In addition to its agricultural imports, New Cornwall has started producing durable consumer goods, using spun glass and foamed orbital steel. These have been well-received across the French Arm and are even exported to Earth, despite the high colonial import taxes.

### **THE JAPANESE COLONY**

*UCP:* C647665-9 Ag Ri 2 0

*Colony Name:* Tosashimizu (Samurai Bay)

*Nationality:* Japanese

Japan settled a colony on Joi in 2257, shortly after the British arrived and, in contrast to the steady build-up of the British, chose to commit a massive effort to build up their colony as quickly as possible. Their expansion has been quite aggressive and they were the first to introduce Terran crops and livestock on a large scale. This caused uproar amongst environmental groups but the Japanese were undeterred.

During the Elysian War, the Japanese offered support to French forces but the offer was declined. To this day it is thought that the Japanese have territorial designs on the former French colony.

### **THE AZANIAN COLONY**

*UCP:* D632644-9 Ag Ri 3 0

*Colony Name:* Lubumbashi

*Nationality:* Azanian

Lubumbashi, the youngest of the Joi colonies, is an Azanian settlement founded in 2280. It has recently reached self-sufficiency in food production and a few luxury crops can be exported to other colonies on Joi or off-world. Like all Azanian colonies, the legal system is kept as minimal as possible, with little interference in peoples' lives, aside from the provision of some medical and social services. The various settlements are widely scattered, with transportation being largely by airship rather than an expensive ground-based infrastructure like roads or rail.

*Character Notes:* Colonists on Joi usually receive the Core Colonist package. Most of the citizens of Elysia, however, are unmodified. They get an extra roll on the Frontier Background Table (see page 90) instead.

Joi has Normal Gravity.

---

'Clever Dragon' One of the species of pseudo-reptiles on Joi has proven to be anything but slow and stupid. These 'Clever Dragons' are warm-blooded animals with high-metabolic rates and large brains. Studies have shown them to be at least as intelligent as terrestrial mountain gorillas and some suggest that they may even be sentient. Efforts to protect the region where the creatures are most numerous are being resisted by all the colonial governments, save Elysia, which rather predictably supports the move. The Elysians have even gone so far as to suggest withdrawing all human settlement from the continent in question.

---

## **CRATER**

*UWP: B751666-9*

The world's namesake is a massive 1,600 kilometre diameter impact crater in the southern hemisphere. Research suggests that the impact blasted away much of the world's atmosphere and wiped out nearly 90% of the plant and animal life on the world. The planetoid fragment that struck had an unusually high concentration of radioactivity and other heavy elements and so while the rest of the planet is largely worthless in terms of natural resources, the area of the impact crater is extremely rich. The bottom of the impact crater itself is covered with a network of lakes and swamps and is uncomfortably hot. The only comfortable area within the crater is the mountain at its centre, the result of upwellings after the initial impact.

### **COLONIAL DATA**

*UCP: B625664-9 Po 5 0*

*Colony Name: Crater*

*Nationality: British*

The majority of the colonists are concentrated in the small city of Rimview on the upper edge of the crater. Many alternatives were initially considered before this site was chosen; it represents a compromise between a number of different possible sources of discomfort. Most of the city's populace is employed in various light industries supporting mining or ranching. Notable features of the city include the large orbital catapult on the east edge of the city, the large elevator complex that allows a descent to the crater floor and the fusion plant located there and a network of underground flare shelters built into the crater wall below the city.

The colony on Crater is not an easy one to live in. Colonists living and working in the desert uplands must contend with a thin atmosphere, desert temperature extremes, a lack of potable water and other unpleasantness. Prolonged exertion is almost impossible in the uplands because of the low partial pressure of oxygen and the already thin atmosphere. As for temperature, the daytime temperature in the uplands can climb as high as 30°C and drop to near 0°C in darkness. These extremes are the result of the thin atmosphere, which has poor heat-retentive qualities.

The miners who work within the crater have a different set of problems to contend with. The atmospheric pressure within the crater climbs as one approaches the floor of the rim; at the lowest levels, it approaches Earth-normal pressure. However, decreased altitude also brings a significant increase in temperature. The floor of the crater consistently runs 10°–15°C higher than the upland temperatures. In full daylight, this is above the level of normal human tolerance and unmodified miners must wear protective clothing.

*Character Notes:* The upland farmers and ranchers on Crater usually get the ThinAir DNA modification. However, the miners will generally opt for the Hot Climate adaptation. While the two genetic communities are cordial, Crater does not have the

medical facilities in place to allow the sort of genetic intervention necessary for interbreeding between the two groups.

Crater has Low Gravity.

## **ADLERHORST**

*UWP: C986625-9*

### **SYSTEM DATA**

*Primary Name: Vogelheim*

*X, Y, Z Coordinates: -29.6, -5.9, 19.4*

Adlerhorst is a comfortable world towards the end of the French Arm, on a dead-end finger. This rugged planet supports a very diverse ecosystem, from the bottom of the oceans to the tops of the highest peaks. Most of this biological wealth is fully compatible with human dietary requirements. Unfortunately, humans are likewise eminently digestible to most of the world's predators.

One of the most unique features of Adlerhorst is the domination of the two pseudo-avian animal groups over the other animal types in the eco-system. Unlike the birds of Earth, the Tomavians (almost birds) and Xenoavians (strange birds) have largely kept their teeth and many have manipulator appendages at the carpal joints of their wing-like forelimbs.

### **GERMAN COLONIAL DATA**

*UCP: C546645-9 Ag 5 0*

*Colony Name: Adlerhorst*

*Nationality: German*

The Bavarians were the first to settle this rich world and made the most of their colony, despite the distance from Earth. It is primarily an agricultural settlement and much of the work is still done with animals and brute force methods. Nonetheless, it is a highly-productive colony and shipments of luxury foodstuffs and some wonderful beers, are commonly exported.

During the War of German reunification, tensions ran very high on this world. An unsuccessful attack on the world's sole

## **HUMMERS (PTERODEIMOS VAR.)**

A bipedal carnivore native to the uplands of Brunnquell similar to the now extinct Diatrema of the Oligocene epoch on Earth. Their distress call is a loud, low-pitched hum, hence the name commonly applied to them by the early colonists. Hummers have effectively lost their wings but they retain large, wickedly curved claws on their legs, which they use to bring down their prey. Hummers attack in family groups, usually of six or more individuals, chasing their prey to exhaustion and then moving in for the kill with great slashing leaps. These fierce hunters are now largely restricted to the sparsely settled north-western plains of Brunnquell. Hummers range from 100–400 kilograms in weight and one to two metres in height.

# Crater

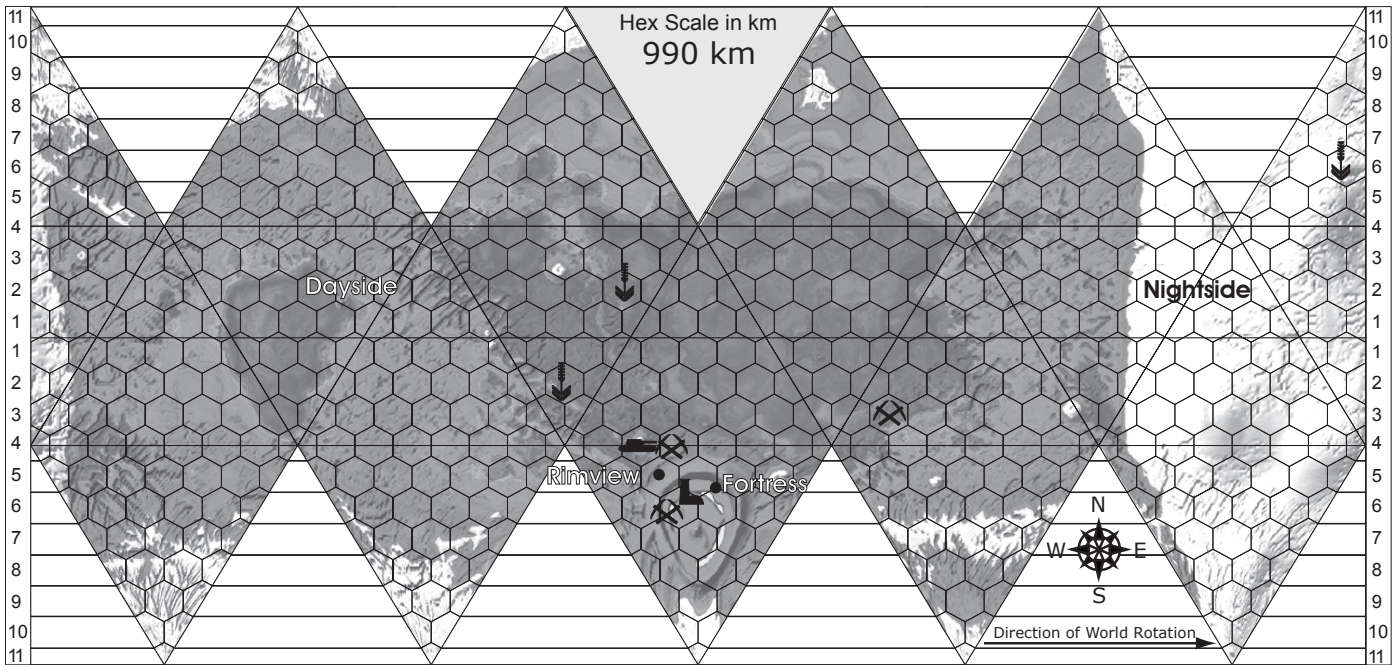

# Adlerhorst

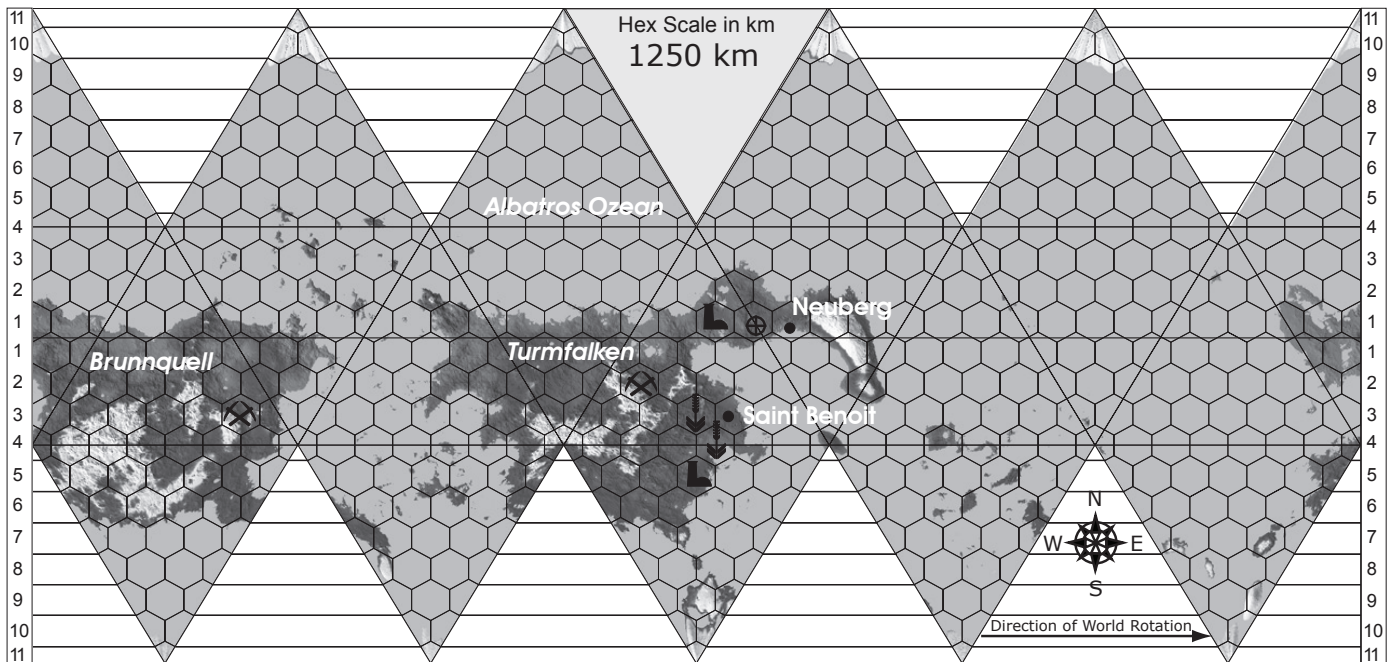

## Legend

- Major City
- ⊗ Mining
- ⌒ Fusion Plant
- ⊕ Spaceport
- ↓ Farming
- ▬ Solar Power Rectenna
- Catapult
- 🏠 Military Base
- 🏭 Heavy Industry

spaceport by German ultra-nationalists enflamed the passions into open warfare. By the end of the war on Earth, a multi-national peacekeeping force had intervened on Adlerhorst, restoring some semblance of peace to the planet. Tensions between the two colonies still run high.

## FRENCH COLONIAL DATA

*UCP:* D556645-9 Ag 4 0

*Colony Name:* Adlerhorst

*Nationality:* French

The French colony was settled well over a decade after the Bavarian colony but France poured more resources into the colony in an attempt to upstage the Bavarian effort. While the colony certainly has more industry than its rival and the farming efforts are much more advanced, it has yet to attain the sort of export success enjoyed by its neighbour.

The current tensions are exacerbated by a combination of a sense of betrayal, as until recently the French and Bavarians had been close allies and the sort of rage that comes from being beaten by an inferior opponent. French citizens are still smarting from the defeat experienced during the War of German Reunification and are not liable to soon forget it.

*Character Notes:* Most of the colonists on Alderhort have the common Colonial Core DNA modification. Some, however, have opted for the Fast Response modification, in order to deal with some of the more predatory Xenoavians.

Adlerhort has Normal Gravity.

## NOUS VOILÀ

*UWP:* DA65643-9

## SYSTEM DATA

*Primary Name:* Beta Comae Berenices

*X, Y, Z Coordinates:* -22.9, -7.2, 12.8

Nous Voilà's climate was not always as temperate as it is today. When explorers first discovered it, it had an adequate atmosphere but was cold, with ice caps covering most of the planet's surface and holding most of the available water. Native life was adapted to this temperature, with hardy plants and a few small sea creatures but no land animals.

Using a variety of techniques, France terraformed the world over the course of two decades, raising the world's climate from Cold to Temperate.

*Terraforming:* French scientists used a genetically-engineered micro-organism to make the planet inhabitable to man. The microbe was let loose on the planet's surface where over a period of 12 years it spread over the ice caps. The dark colour of the tiny creatures changed Nous Voilà, warming the planet and melting most of the ice caps and glaciers except at the poles.

Once the change was in effect, a second biological agent was released to kill the micro-organism. The world was quarantined for another six years to prevent the undesired contamination of other worlds before the micro-organisms were totally destroyed.

Human ingenuity had changed a frozen, barren world into a garden ready for planting. Nous Voilà's terrestrial biology is now almost entirely Terran, with some forms allowed to run free, notably mule deer, grey wolves and European bison.

## COLONIAL DATA

*UCP:* D656657-9 Ag Po 4 0

*Colony Name:* Nous Voilà

*Nationality:* French

Nous Voilà is a pleasant colony world characterised by scattered villages and productive farms. The first settlers were from French Africa, primarily Cameroon and Senegal. Later colonists followed from continental France, fleeing the latest round of government obtrusiveness and the tightening of the surveillance loop. Nouveau Amman is often characterised as being quite libertarian. Recently, colonists have been allowed to hunt the various terran animals released into the wild.

## DUNKELHEIM

*UWP:* B444544-A

## SYSTEM DATA

*Primary Name:* DM+36 2393

*X, Y, Z Coordinates:* -23.5, -10.4, 18.5

Dunkelheim is a near-desert world in the outer reaches of the French Arm. Agriculture is difficult at best but the world is a rich source of valuable ores. Much of the world's surface water is locked up in kamelinsekten hives, vast honeycombs of tiny chambers that soak up water like a rocky sponge. Due to some relatively recent environmental capacity, the kamelinsekten have no natural predators. They have a tendency to swarm whenever they leave a nest and a swarm can injure or even kill unprotected humans and their animals.

## COLONIAL DATA

*UCP:* B454644-A

*Colony Name:* Dunkelheim

*Nationality:* German

Dunkelheim is a fairly unpleasant world and served for a time as a Bavarian penal colony. At the time of colonisation, Bavaria and several of her terrestrial allies were having a problem with vice crime. The Bavarian treasury was strained by the effort of incarcerating these people but at the same time the Bavarians needed colonists for the relatively unpleasant world just opened up on the edge of the frontier: Dunkelheim. These two problems were solved in one stroke and convicts with useful skills were deported to Dunkelheim.

# Nous Voilà

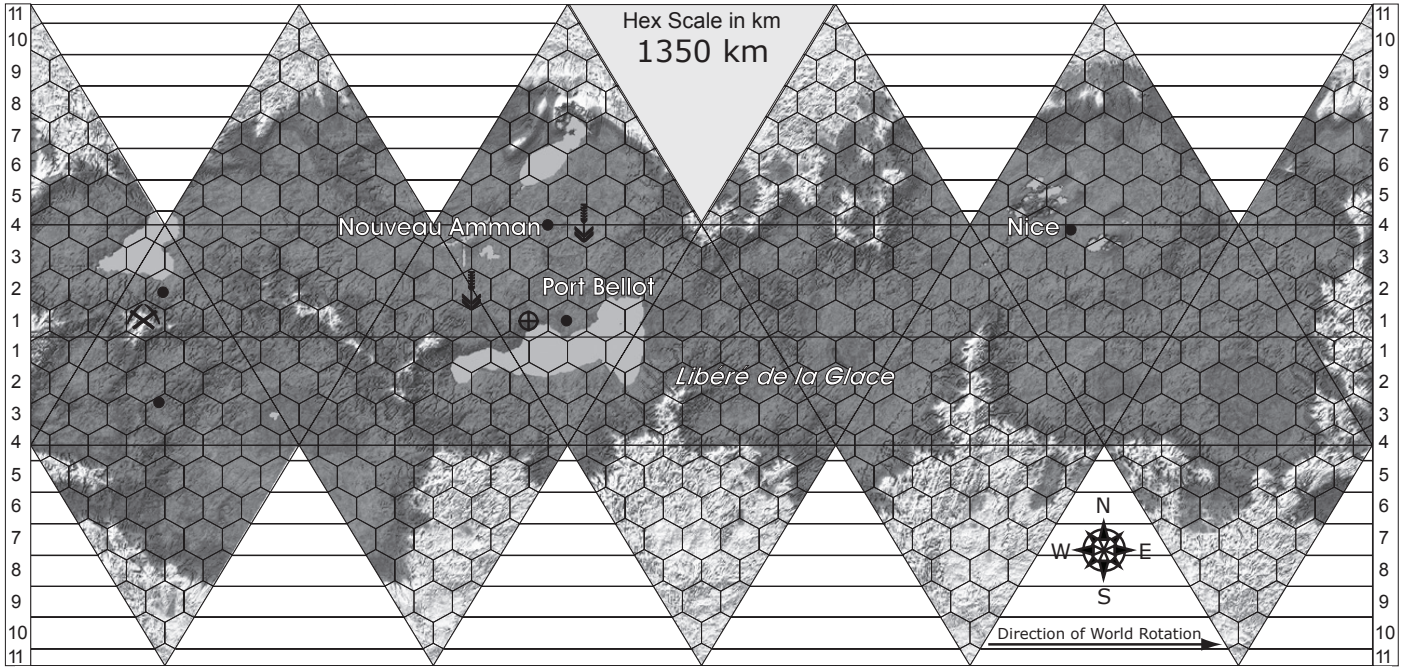

# Dunkelheim

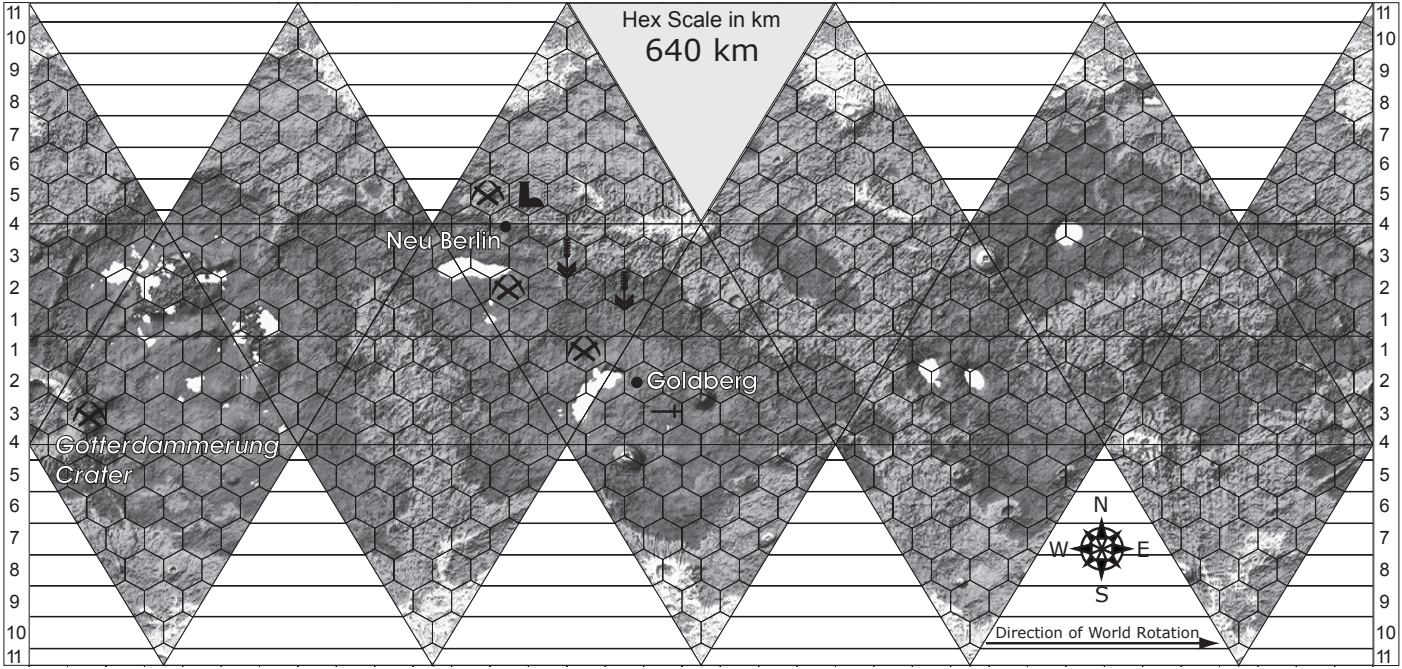

## Legend

- Major City
- ⊕ Spaceport
- Catapult
- ⊗ Mining
- ↓ Farming
- 🏠 Military Base
- ⌚ Fusion Plant
- ☰ Solar Power Rectenna
- 🏭 Heavy Industry

## WRITING WITH A DUNKELHEIM PEN

In 2286, political scandal rocked this colony, as it was found out that pens used by many of the government offices were transmitting both sound and penstrokes to the interstellar trading company of Hofstader. The resulting uproar shut the company down and nearly caused a change of government in the colony.

The current libertarian society celebrates this notorious past.

*Character Notes:* Most Dunkelheim citizens have the Dryworld DNA modification, though a significant number (~15%) have no DNA modification at all.

Dunkelheim has Low Gravity.

## Hochbaden

UWP: B400648-C

### STELLAR DATA

*Primary Name:* Hochbaden

*X, Y, Z Coordinates:* -24.9, -12.6, 14.3

*Planets:* Hochbaden, Stein, Sturmwelt, Hoffman

Hochbaden is defined as a desert world. It has a very thin atmosphere that can cause erosion and occasional dust storms but cannot support human life. Aside from some microorganisms found around the fringes of poles, Hochbaden is a world without life. Even these microbes are presumed to have been transplanted here by a meteor strike, since they probably could not have evolved under these conditions. Hochbaden has been likened to Mars in many scientific circles.

### COLONIAL DATA

UCP: B628648-C Va NI 6 0

*Colony Name:* Hochbaden

*Nationality:* German

Hochbaden is a collection of surface domes and space stations in an otherwise uninhabitable system. Mining on the surface is supported by extensive gardens and recreation facilities in orbit. Most of the current surface facilities are intended for temporary habitation but the current round of construction is aimed at creating extensive surface arcologies that blend in with the environment, yet allow comfortable human habitation. There are rumours that the German government is seeking to lift the moratorium on DNA modification research so that they can examine the possibility of engineering colonists to a better fit with Hochbaden's surface conditions. This would presumably be accompanied by some manner of terraforming to add oxygen to the thin atmosphere.

*Character Notes:* Most Hochbaden citizens have the Zero-Gee modification, although a few (>5%) have the ThinAir modification, which allows them to live and work in surface domes with a much lower pressure than is normal, reducing the risk of blowouts and other accidents.

Hochbaden has Low Gravity.

## AURORE

UWP: C666674-B

### SYSTEM DATA

*Primary Name:* Muphrid (Eta Bootis A)

*Magnitude:* 2.72

*X, Y, Z Coordinates:* -26.8, -14.3, 10.2

Most of the plants and animals on Aurore are actively poisonous and at best simply provide no nutritional value. Auroran life is based on right-handed amino acids and thus unusable. Many of the animals and the creatures of the anifungus regnum also secrete acid, which is usually more dangerous as a systemic poison than for any corrosive effects.

The human colonies on Aurore have been steadily replacing the native life in selected areas with imported Earth crops. Where terrestrial strains have grown wild in places, they have generally failed in competition with native Auroran forms and colony farms must be carefully and patiently worked to maintain the balance of their miniature and artificial terrestrial ecosystems. Auroran soil is incapable of supporting Terran life and must be carefully sterilised and cultured before human crops can be grown.

### COLONIAL DATA

#### FIRST COLONY

UCP: X625600-8 Po 2 0

*Colony Name:* Novoa Kiyev

*Nationality:* Ukrainian

The Ukrainians were the first settlers of this world and originally the entire planet was named Novoa Kiyev. However, the colony failed to perform as expected and they nearly defaulted on loans and guarantees provided by the ESA to support their colonisation attempt. They since managed to get caught up, only to suffer the full brunt of the alien invasion in 2298.

The colony was devastated and is currently occupied by tens of thousands of alien troops. Conditions within the colony are said to be critical but it is isolated on the far side of the planet from the other two colonies and no help is available.

#### SECOND COLONY

UCP: C735664-A Po 5 0

*Colony Name:* Aurore

*Nationality:* French

The French colony was started after the colonial administration of Novoya Kiyev failed to make good on mineral shipments and other supply contracts. France decided that it would be better to establish its own colony on this distant world. Like the other colonies, they suffered at the hands of the alien invasion force.

The French colony was the best prepared of the three colonies, having started reinforcing the local garrison after the abortive contact

# Hochbaden

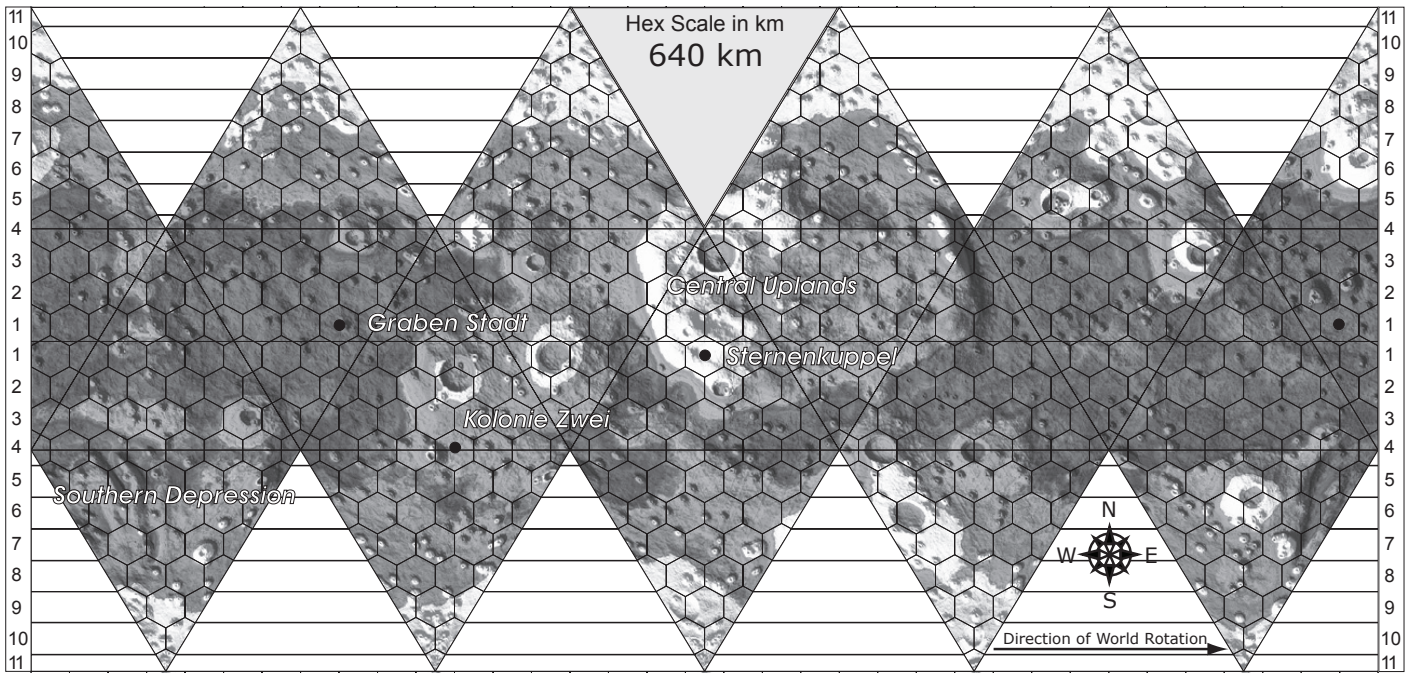

# Aurore

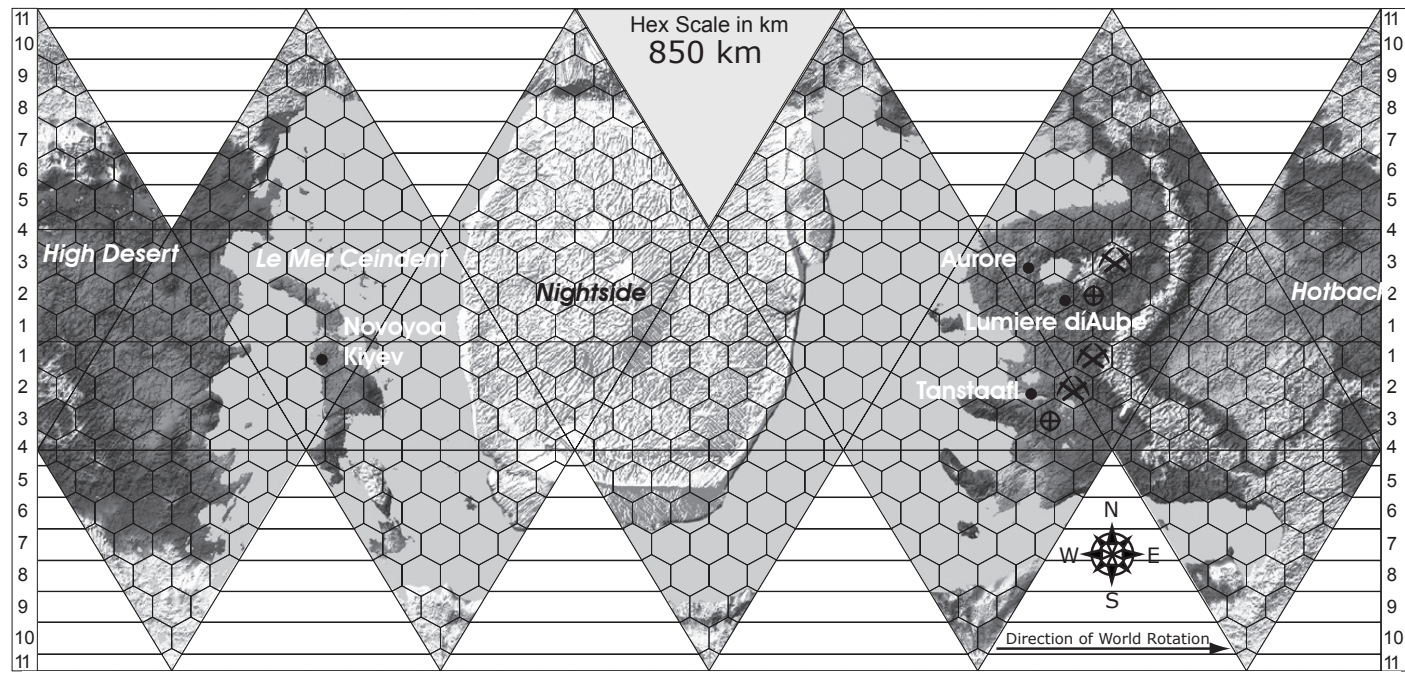

## Legend

- Major City
- ⊕ Spaceport
- Catapult
- ⚡ Mining
- 🌾 Farming
- 🏠 Military Base
- ⏏ Fusion Plant
- ☰ Solar Power Rectenna
- 🏭 Heavy Industry



---

## KAEFER ROT

During their invasion, the Kaefers introduced a fungal weapon that devastated Human crops. This weapon may be related to the fungus that consumes Kaefer bodies when they die.

---

attempt at Station Arcture in 2295. Even so, the colony took extensive damage and roving bands of Kaefers still attack outlying villages.

## THIRD COLONY

*UCP:* C636640-9 Po 5 0

*Colony Name:* Tanstaafl

*Nationality:* Independent

The youngest of the colonies on Aurore, Tanstaafl is also one of one a handful of off-world independent nations in human space. When the original cartel that settled Aurore defaulted and disbanded, the local settlers took matters into their own hands and declared independence in 2259.

When the alien Kaefers invaded, Tanstaafl had no military or defensive forces, aside from the Tanstaafl Rural Police. Initial losses were extremely high among the colonists and the police who struggled to save them. The local government immediately contacted a RebCo SAR factor in neighbouring Hochbaden, begging for mercenaries. Two months later, the core of what would become the Tanstaafl Free Legion arrived on planet, 12 hardened mercenaries from the Indian States, who formed the training cadre for the new force. Two months after that, equipped with surplus armoured vehicles from Adlerhorst, they began pushing the aliens back.

# EXPLORATORY AND UNDEVELOPED WORLDS

## SANS SOUCI

*UWP:* X766214-8

## STELLAR DATA

*Primary Name:* DM+36 2219

*X, Y, Z Coordinates:* -27.9, 1.2, 19.9

Sans Souci is a cold and barren world, similar in many ways to Beta Comae Berenices before it was terraformed. The scientists and engineers who inhabit the small outpost are convinced that with a little help, Sans Souci could be a welcoming world. However, French ambitions lie elsewhere and neither the

military junta nor the Empire that replaced it cared to lay out the resources required to turn Sans Souci into a full-fledged colony.

## Freiland

*UWP:* X6E200-0

## STELLAR DATA

*Primary Name:* DM+10 2531

*X, Y, Z Coordinates:* -39.6, -13.3, 7.1

The world of Freiland is a cool, mountainous world with extensive tectonic activity. The thin atmosphere is only breathable at very low altitudes and the 1,800 kilometre trench system of Grossartige Senke provides the lowest terrain on the planet, up to 4,500 metres below the surrounding terrain. Pressure is nearly normal at the bottom of the trench and almost all the world's water rests here. The trench system supports a well-developed biosphere, with some of the vaguely insectoid animals reaching lengths of 3–4 metres.

The bottom of the Grossartige Senke is in near-total darkness almost all of the time and the animal life has evolved to meet the challenge of these conditions. There are no plants, although something much like a fungus flourishes near the volcanic vents. The basis of the food-chain in the trench is not plants but large colonies of chemosynthetic bacteria that cluster around the many volcanic vents and geysers that line the floor of the canyon. As a by-product of their metabolism, they produce large amounts of oxygen.

Both Freihafen, who surveyed the world and Neubayern are looking at Friedland as a possible colony world. It has exploitable resources and would establish both nations/colonies as serious players on the international and interstellar scale.

## THE CHINESE ARM

The Chinese Arm begins at Delta Pavonis and extends in two directions. One reaches to Beta Hydri, Zeta Tucanae, Rho Eridani and 82 Eridani, all prime colonisation territory. The other reaches through two red dwarf systems (Xiuning and Hunjiang) to the garden worlds of Tau Ceti, Epsilon Eridani and Omicron2 Eridani.

Exploration and settlement of the arm proceeded smoothly until the establishment of an outpost at DM+1 4774 in 2247. Shortly thereafter, a Manchurian exploratory mission was sent to DM+4 123 and returned with the electrifying news that the star system was inhabited by an indigenous intelligent race, the first to be encountered by humanity. Most nations of the Earth hastened

# Sans Souci

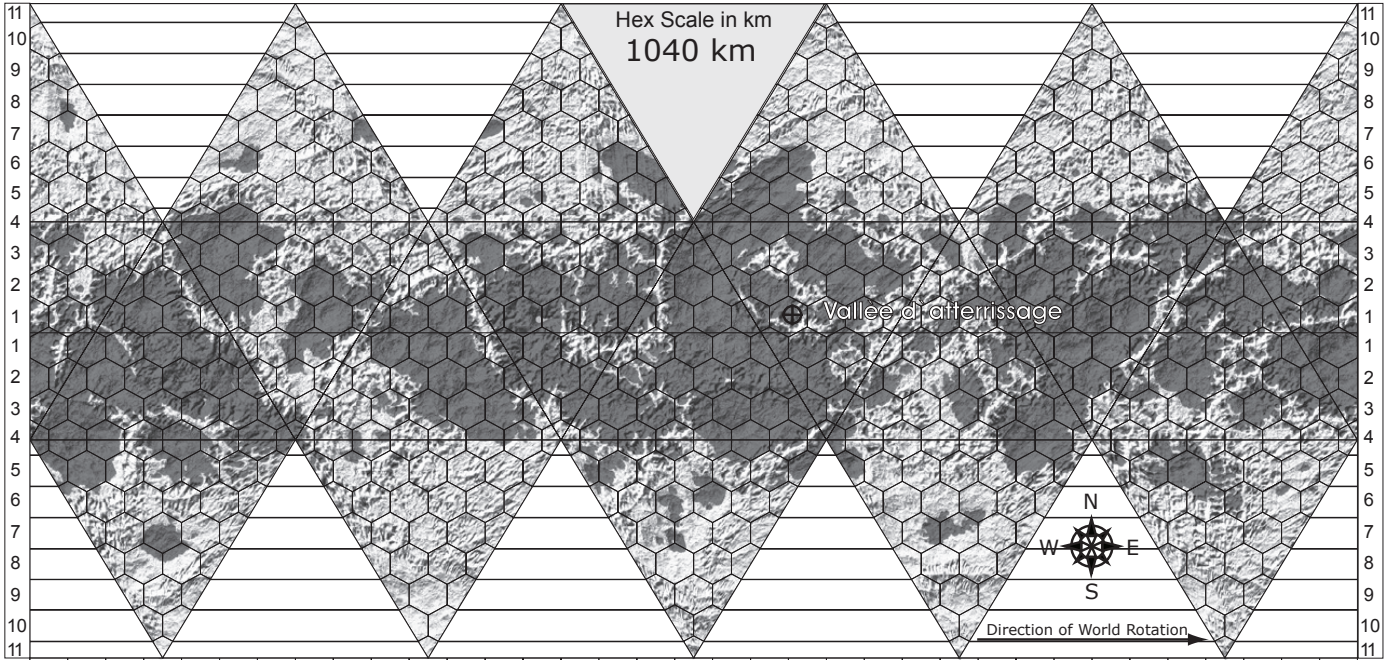

# DM+10 2531 (Freiland)

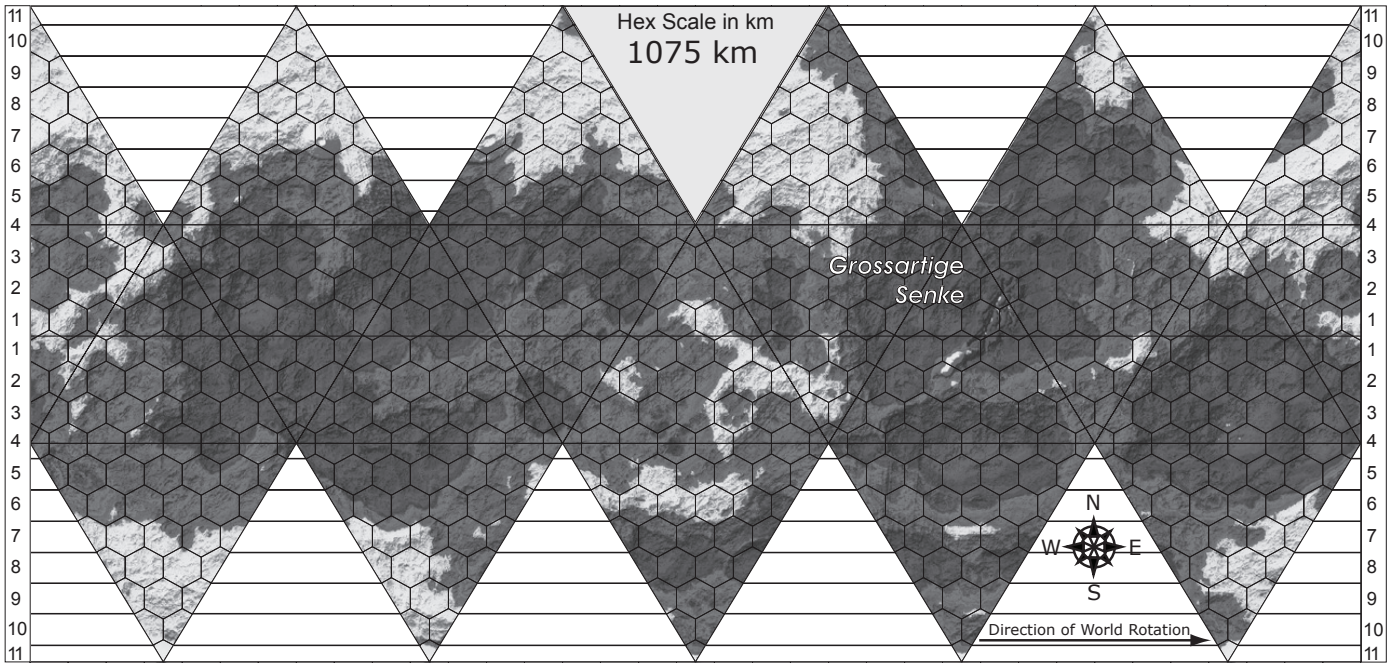

## Legend

- Major City
- ⊕ Spaceport
- Catapult

- ⚡ Mining
- 🌾 Farming
- 🏠 Military Base

- ⚡ Fusion Plant
- ☀️ Solar Power Rectenna
- 🏭 Heavy Industry

to open a variety of diplomatic and cultural contacts with the race the Manchurians named the Sung (in common with all intelligent races encountered by humanity, their own name for themselves, Ak-char'al-woon, translates roughly as 'thinking being'). The discovery of another intelligent race in the Stark system, enslaved by the Sung, led directly to the Slaver War, where Manchurian and Canadian forces decimated the Sung fleet and freed the peaceful garden moon.

During this same period (the mid 23rd Century), explorers and colonists in the Beta Hydri branch of the Chinese Arm discovered the ruins of a colony established some 4,000 years previous. Another ruined colony was found at Rho Eridani shortly after that.

A few years later, an exploratory mission of the United Arab Republic visited 82 Eridani and discovered the Ebers. Considerably less advanced than humankind, the Ebers were nevertheless open to limited contact. Since then, two major colonial enclaves have been established on Kormoran, the Eber homeworld.

Colonisation of the Chinese Arm has, overall, been very successful and there are plenty of systems that have yet to be explored and colonised. Terrorist actions have long been a problem on the Chinese Arm, with a wide variety of groups claiming responsibility, from the universal scapegoat of ProVolution to such fringe groups as the Daughters of Mao. These attacks tend to be small and localised, although there are indications that something big is going to happen soon. Of course, people have been saying that for 20 years.

Life on the worlds of the Chinese Arm tends to be rougher than the other Arms. The longer distances involved in the twisting routes of this Arm mean fewer trips, with priority going more to colonists and animals than to heavy equipment and infrastructure. There is much more reliance on animal power on the worlds of the Chinese Arm, especially the Manchurian colony worlds, which see the lowest level of infrastructure support and are expected to succeed under primitive conditions with little aid from the mother country. The Inca Republic is in largely the same situation, without even the limited resources available to the Manchurians. Their success is largely due to their tendency to piggy-back on Texan colonies.

### **The Canadian Finger**

Canadian explorers were the first to chart the system of DM+20 5046 (Kanata), a distant but attractive system. In order to support a colonisation effort, Canada found it necessary to establish a series of outposts (DM+19 5116 and DM+15 4733) to service ships travelling there. The series of systems is called the Canadian Finger. The finger also leads to Eriksson, a relatively pleasant planet at AC+17 534105. Canada, the Scandinavian Union and an alliance of five major Sung nations are looking at colonising efforts on this world.

### **The Latin Finger**

Extending from Epsilon Eridani is a finite branch reaching as far as Procyon before dead-ending. Paradoxically, the route to

Procyon (so very close to Earth) is one of the longest in general use. The expedition to colonise Omicron2 Eridani was jointly funded and supported by Mexico and Argentina and the world is a gateway to the Latin worlds: DM-3 1123 (the Inca Republic, Texas and the Life Foundation) and Procyon (Brazil).

## **WORLDS OF THE CHINESE ARM**

### **COLD MOUNTAIN**

*UWP:* C6D6766-8

#### **SYSTEM DATA**

*Primary Name:* Delta Pavonis

*X, Y, Z Coordinates:* -3.79, -6.50, -17.10

Technically, Cold Mountain is a garden world but its human inhabitants would hardly agree.

Due to an excess of oxygen in the atmosphere (39 percent), settlements are impossible below 3,000 metres elevation. This excess poses a direct health risk and puts strict limits on the type of equipment that will function below this altitude. Excess oxygen has, over time, led to an acidification of the atmosphere, the water table, the seas and the soil. Metals corrode and oxidise rapidly at sea level, often within hours. The oxygen problem leads to another, perhaps more dangerous problem. A fire on Cold Mountain is never a trivial event. Lightning, volcanic activity and other natural forms of ignition create firestorms that spread rapidly over the surface of the planet. Some of these firestorms are large enough to be visible from the orbit. At any given time, some part of the planet will be burning out of control. At higher altitudes, these conflagrations lose force and burn with the intensity of terrestrial forest fires.

#### **PROPER COLD MOUNTAIN ATTIRE**

Normal outdoor clothing on Cold Mountain is a relatively lightweight but fairly thick suit with metal reinforcement at vulnerable areas. Headwear is a padded hood, along with a large, conical metal hat, to protect the head and shoulders from attack by blinds or razor flies. A fine mesh made of metal links hangs down from the hat to drape across the shoulders as further protection. All footwear has metal inserts in the sole of the boot, rendering them somewhat inflexible but immune to sandworms and screwworms.

*Nation:* Cold Mountain

*Weight:* 5 kg

*Protection:* 3 (full protection against Demon attacks and other bladed weapons.)

*Price:* Lv75

All citizens over the age of 10 are encouraged to carry the local long sword or long-bladed spear.

# Cold Mountain

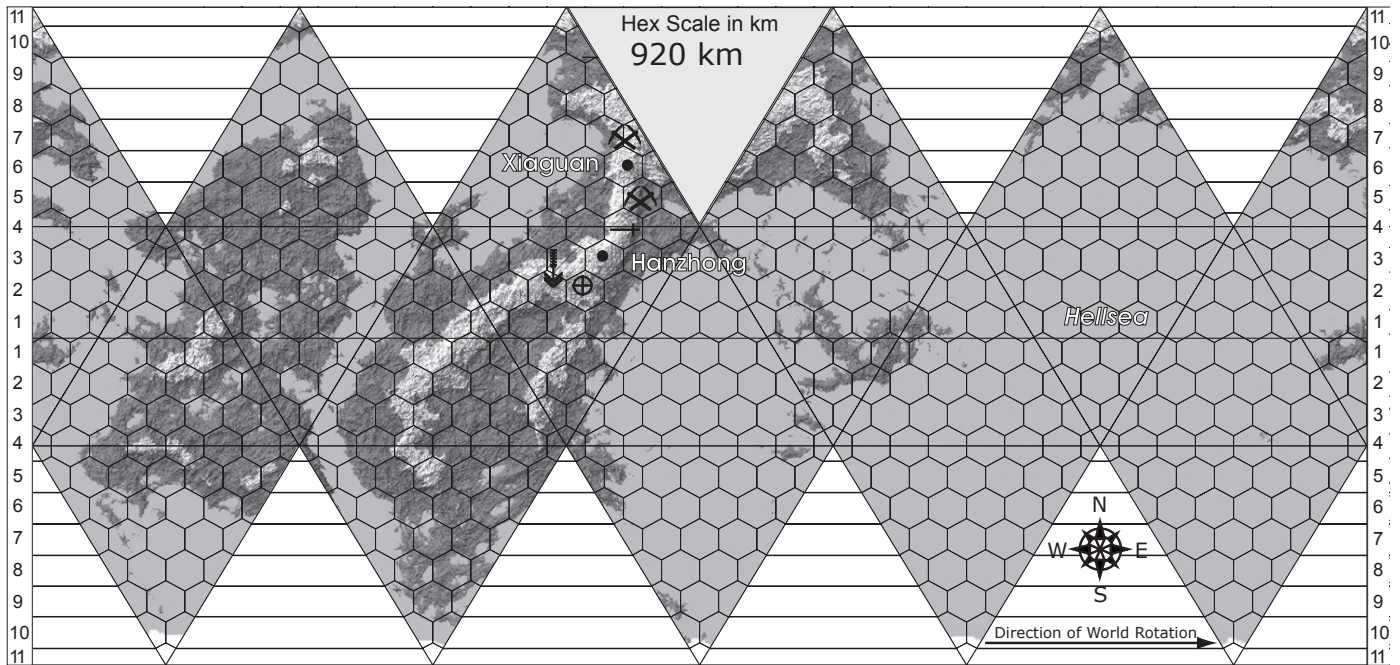

## Legend

- Major City
- ⚡ Mining
- ⌚ Fusion Plant
- ⊕ Spaceport
- ⬇ Farming
- ☰ Solar Power Rectenna
- ➔ Catapult
- 🏠 Military Base
- 🏭 Heavy Industry

As hostile as these conditions are, however, they pale in comparison to the hostility and lethality of the world's animal life. Although relatively primitive, the animal life of Cold Mountain drifts through the air or scurries along the ground on multiple blade-legs or burrows through the ground to attack from below. Cold Mountain animals always attack and, given their speed and near-invisibility, they often succeed. Only the ice caps and mountains above 8,000 metres are relatively free from the creatures the locals call Demons.

## COLONIAL DATA

UCP: B653746-8 Po 1 0

Colony Name: Han Shan (Cold Mountain)

Nationality: Manchurian

Colonisation of Cold Mountain was costly. Over half of the original 12,000 settlers were lost to local dangers. But this was Manchuria's first colony world and every effort was made to make certain it survived, even at a severe cost to the Manchurian homeland. New colonists were sent to replace those killed and to broaden the population base. To this day, Manchuria supports a strong emigration policy to Cold Mountain. The prospects are tempting enough for would-be colonists to ignore the inherent dangers. This strategy has prevented the development of local

dialects, while strengthening planet-wide gratitude toward and honouring of Manchuria.

To protect themselves and their valuable terrestrial imports, the settlers used locally mined stone to erect walls separating the lower elevations from the higher. The walls were strung with wire nets to keep out the flying blinds and the large razorflies. Out of necessity, colonists still perform 'watch duty' on the walls, armed with polearms, swords and other bladed weapons. Being selected for guard duty is considered a great honour, despite the hazards.

## DEMONS

The adversarial relationship the colonists of Cold Mountain have with their new home is highlighted by the animal life of this planet. Highly dangerous, hard to see and even harder to kill, they have become more than animals in the minds of the settlers and have transcended to the status of demons. Practically all colonists know someone who was killed by a demon and many colonists suffer scars from chance encounters. Firearms are largely useless against many of them and the colonists have fostered a strong martial tradition based around swords and long-bladed polearms.

# CHART OF THE CHINESE ARM

circa 2300AD

Using the Zenith projection concerning the arms of Humanity's Sphere, the location within 50 light years and its central point of Sol.

- ★ Homeworld of a sentient species.
- Star system and, therefore, a stuttwarp discharge point.
- A traversable route being equal to or less than 7.7 ly.

## INTERSTELLAR TRAVEL TIMES

Depending on mass & drive, between 0.15 and 9.5 ly per day. The maximum distance a vessel can travel is 7.7 ly between stars as a stop in a gravity well is required for driver/crew safety and performance. Stuttwarp discharge requires approx. 40 hours.

## Sung Space

★ DM+4 123

Stark  
Motherhome

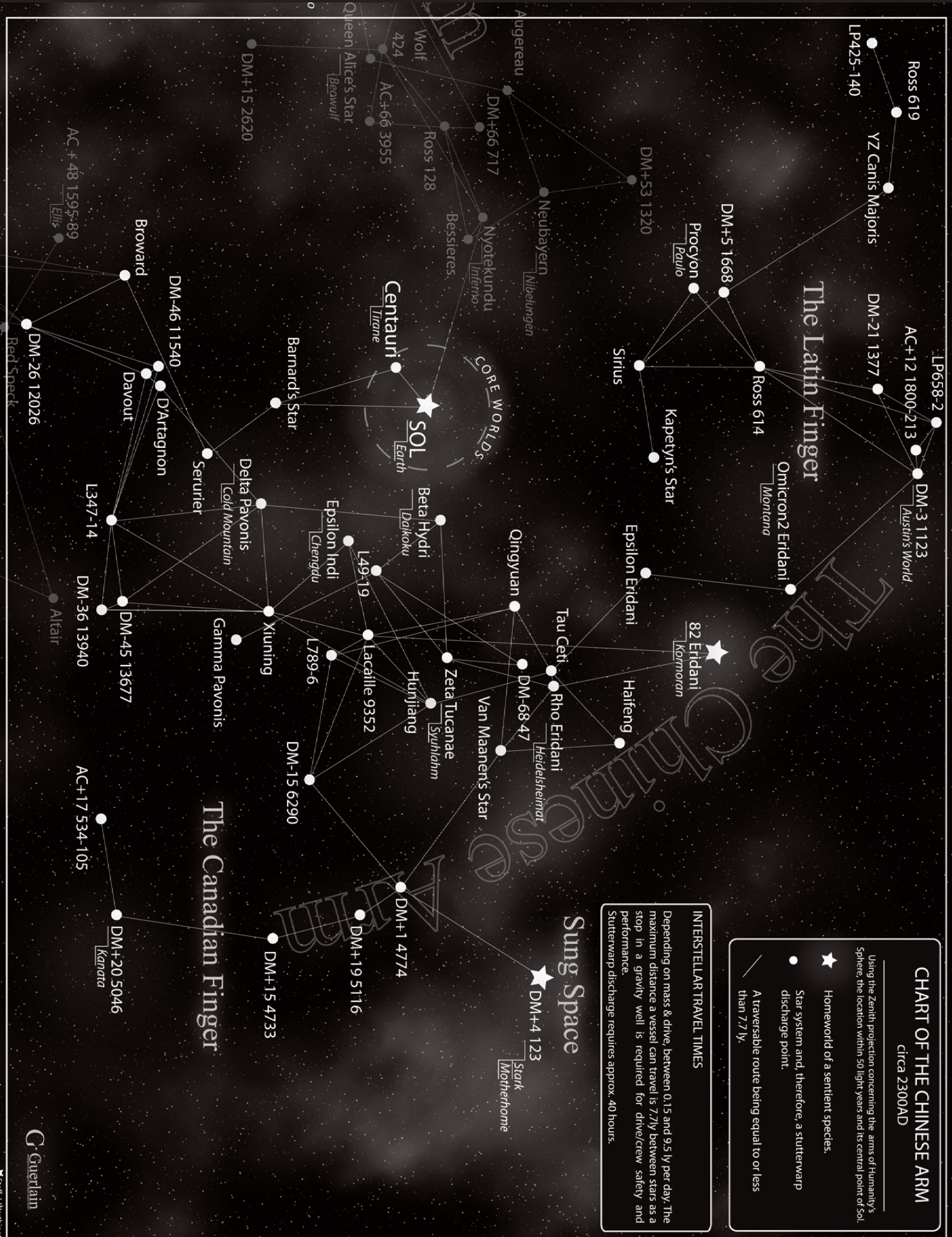

Colonists usually undergo some sort of rigid martial training involving primitive and modern weapons adapted to better defeat local animals. Their padded clothing is often armoured against sudden attacks.

*Character Notes:* A significant number (50%) of Cold Mountain citizens do not have any sort of DNA modification. Those who do, overwhelmingly have the Rapid Response modification. However, any second generation or later colonist will have the Fast Advantage, regardless of any DNA modification. On this world, only the fast survive. All Cold Mountain residents will have Melee 1 as part of their background skills. All colonists on Cold Mountain have an additional -1 to their survival checks and new colonists have a -2 for their first term only. For second and subsequent terms, they have the same -1 penalty as everyone else on Cold Mountain.

Cold Mountain has Normal Gravity.

## **DAIKOKU**

*UWP:* B654777-B

### **SYSTEM DATA**

*Primary Name:* Beta Hydri

*X, Y, Z Coordinates:* 4.4, 0.4, -20.1

In 2249, the ruins of an ancient technological culture was discovered near the Arabian colony. This was evidence for a second interstellar civilisation, although the ruins had been abandoned for at least a few thousand years.

Further evidence for this civilisation was found on Heidelshiemat in 2253 and in 2256 the Ebers, who had colonised those worlds thousands of years ago, were first contacted on a planet orbiting 82-Eridani.

Study of the ruins is ongoing and even with live Ebers to study on Kormoran, new discoveries are being made at both ruins sites on Beta Hydri.

### **COLONIAL DATA**

*Colony Name:* Daikoku

*UCP:* B667745-B Ri Hi 1 0

*Nationality:* Japanese

The Japanese colony on Daikoku is essentially self-sufficient, with most of the population living comfortably (only a very few could be said to be living affluently). Most colonists work for companies, rather than being self-employed. These companies vary greatly in size, from small companies based exclusively in Daikoku to large corporations, which may have headquarters off-world. Employees of these companies are hardworking and fiercely loyal to their employers. There is an emphasis on tradi-

tional cultural values in the colony, with concepts like personal honour being taken very seriously.

*Colony Name:* Far Riyadh

*UCP:* C564664-8 Ri, Ag

*Nationality:* Arabian

Since its founding 75 years ago, the Arabian colony on Daikoku has done well for itself. Also essentially self-sufficient, the Arabian colony engages in trade both off-world and with the Japanese on-world, dealing mostly in textiles, handcrafts, petroleum products (notably synthetic materials) and perfumes. Culturally, the Arabian colony follows a fundamentalist version of Islam, which requires both genders to completely cover themselves when out of the house. A similar strict equality applies in all facets of their daily life.

*Character Notes:* While the Japanese citizens of Daikoku are happy to have the Hot Climate DNA modification, the Arab colonists of Far Riyadh are not permitted to have DNA modifications due to the strictures of their particular brand of fundamentalist Islam. They instead receive Survival 1 in addition to any other background skill and Traits.

Daikoku is a Low Gravity World.

## **SYUHLAHM**

*UWP:* B867665-A

### **SYSTEM DATA**

*Primary Name:* Amah

*X, Y, Z Coordinates:* 9.7, 0.7, -21.2

Syuhlahm proves that an Earth-like world need not have an Earth-like biosphere. The biological mechanisms of this world are very different from those encountered elsewhere. All of Syuhlahm's higher organisms are advanced symbiotes based on a limited number of common parts: limbs, leaves, sensors and organs. These join in various combinations to form wholes. Serious damage to one of these multi-part creatures will often cause the various constituent creatures to release from the main body and scurry off into the undergrowth. There have been recorded cases of humans being parasitised by these creatures, with no advantage to the human.

### **COLONIAL DATA**

*UCP:* B755665-A Ri In 5 0

*Colony Name:* Chyuantii

*Nationality:* Manchurian

Chyuantii was Manchuria's third extra-solar colony and has seen rapid industrial development since it was founded. It is one of

# Daikoku

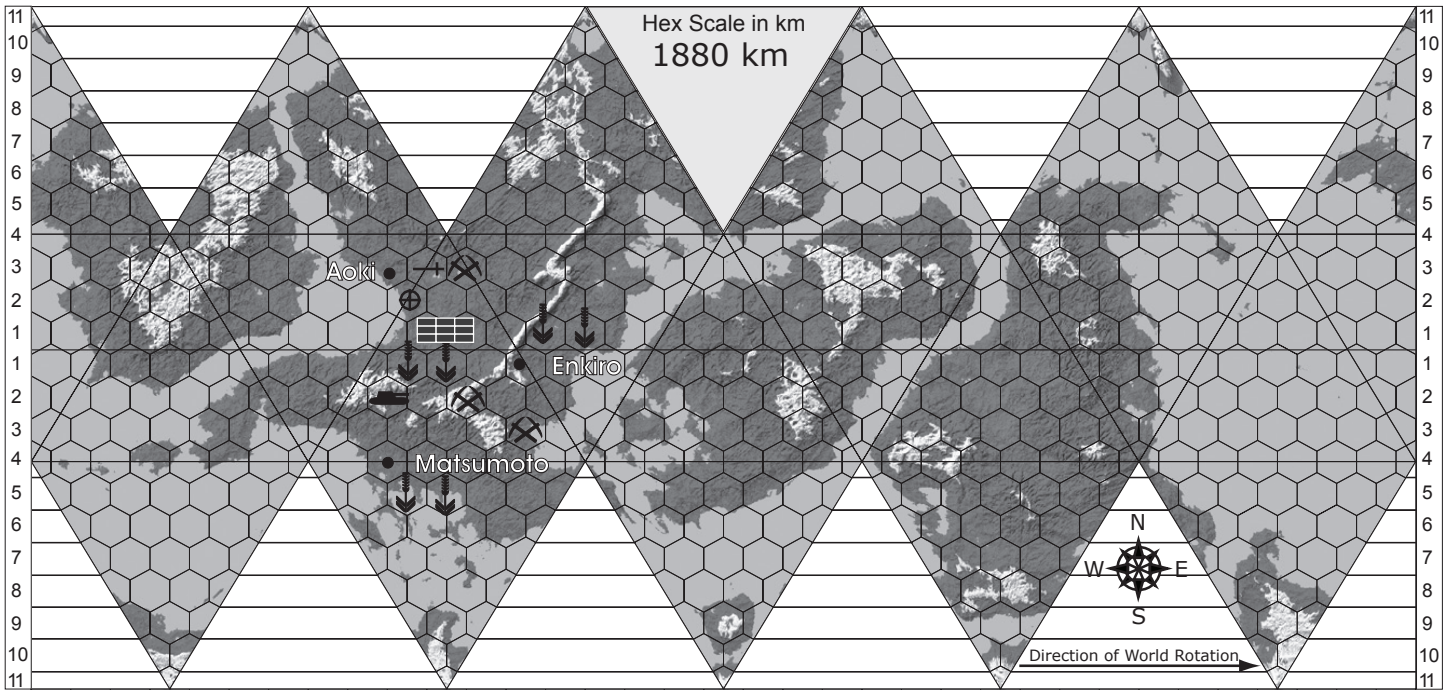

# Syuhlam

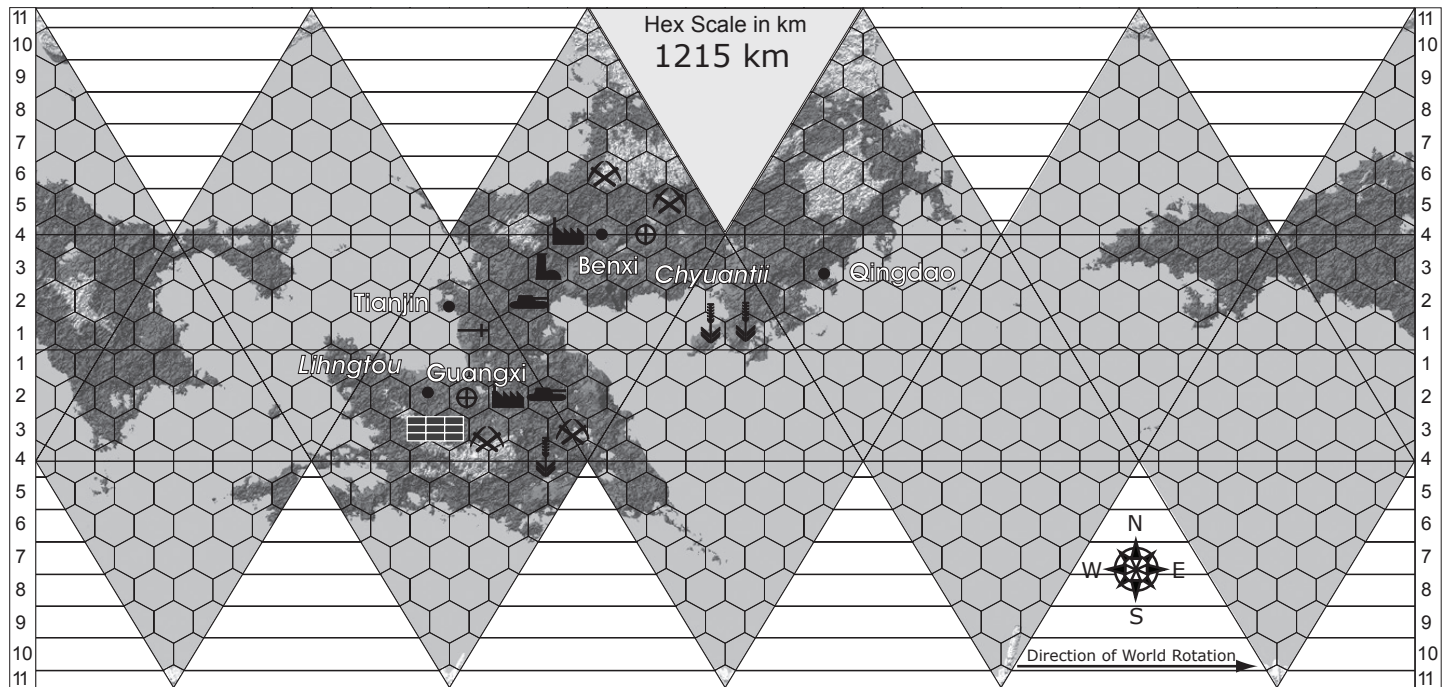

## Legend

- Major City
- ⊕ Spaceport
- Catapult

- ⚒ Mining
- ↓ Farming
- 🏰 Military Base

- ⚡ Fusion Plant
- ☄ Solar Power Rectenna
- 🏭 Heavy Industry

the most advanced Manchurian colonies and its industrial output makes it a major economic player on the Chinese Arm. Ironically, one of its biggest customers is its sometime rival, Lihngtou. Life in Chyuantii is good, with a high demand for both skilled and unskilled labour.

**LIHNGTOU**

UCP: C732662-9 Ag, 7 0

Colony Name: Lihngtou

Nationality: Cantonese

Canton negotiated with Manchuria between 2240 and 2255 to arrange placement of a colony during a period when the two nations had relatively friendly relations. Since Manchuria would be unable to prevent the placement of a Cantonese colony on Syuhlahm, it was to their advantage to participate in the planning of a new colony, regardless of who placed it.

Chyuantii and Lihngtou have a long-standing rivalry, which dates from the first establishment of Lihngtou. Although both colonies depend on each other economically, culturally they are great rivals and occasional enemies.

Syuhlam is a major producer of combat walker systems, which, along with customised animals, forms the major exports for this world.

**HEIDELSHEIMAT**

UWP: B867778-C

**SYSTEM DATA**

Primary Name: Rho Eridani

X, Y, Z Coordinates: 10.7, 4.8, -17.8

With an axial tilt of 13.3°, seasonal variation of the hours of daylight on Heidelshemat is not as great as on Earth. The differences in temperature between winter and summer on Heidelshemat are also less pronounced than on Earth, giving rise to a more temperate climate in general at the middle latitudes.

*Native Life:* Life on Heidelshemat has evolved to levels of complexity comparable to those on Earth. Much of the land-based life takes advantage of Heidelshemat's low gravity and comparatively dense atmosphere and are either gliders or true flyers. Some of the gliders, like the Sky Jumper, leap from a height, either a tree or cliff, while others, like the bush bunnies, leap three or four metres into the air and glide from there. Although Terran and Heidelshematian biologies are incompatible, some of the local wildlife has been known to gorge on Human crops, only to die of starvation with their bellies full.

The Heidelshematian plant life has a number of interesting adaptations, most of which are simply annoying to the colonists. Umbrella trees release large, parachute-like seeds that can drift for many kilometres, occasionally coming to rest on some of the carefully planted terrestrial plants. Others shoot their seed in

**Heidelsheimat**

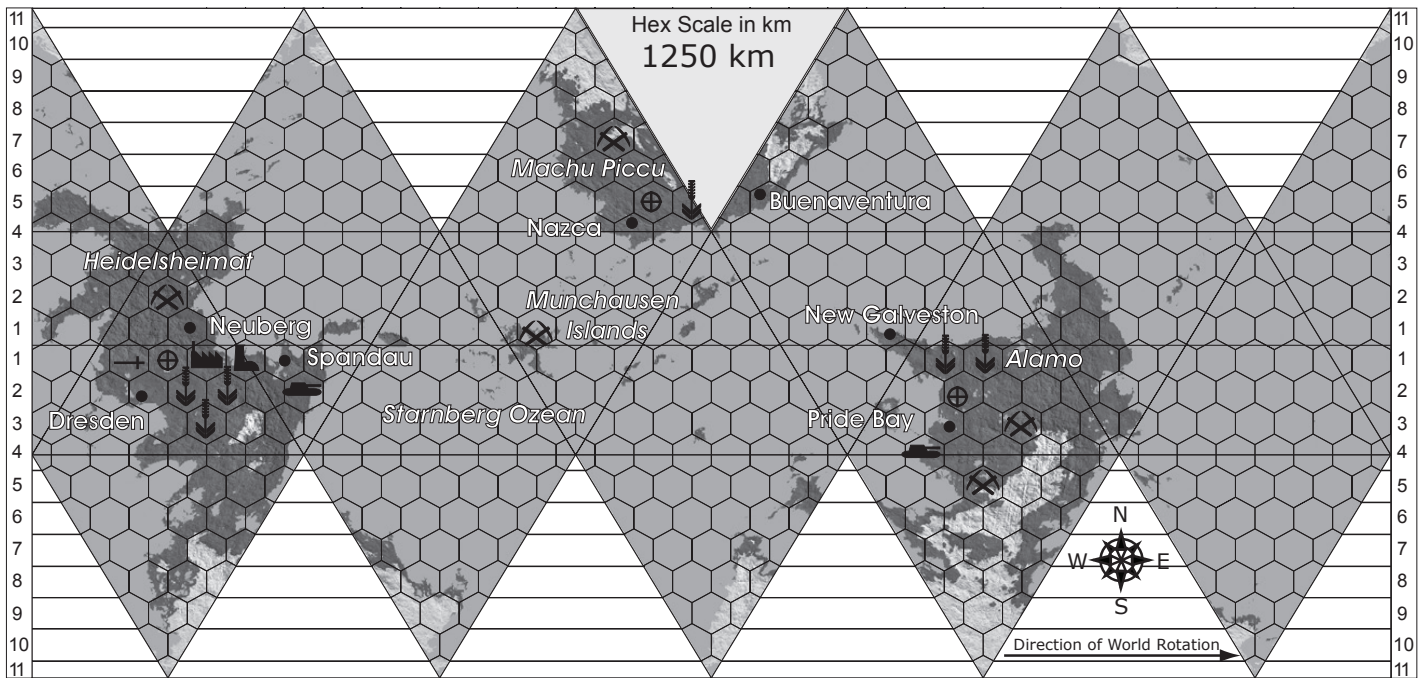



response to external stimuli, like being stepped on, while many others have sticky/hooked seeds that can be difficult to remove from clothes, vehicles and buildings.

## THE GERMAN COLONY

UCP: B676745-B Ri, Hi 1 1

*Colony Name:* Heidelshemat

*Nationality:* German

The Heidelshemat colony settled and controls the mining outpost of Geroellblock at DM-56 328, making it one of the only colonies with a colony of its own. The combination of the two settlements has produced a very powerful colony, one with the resources it needs and a pleasant world to work with. Food for both is imported from the Japanese at Beta Hydri but the government is looking to end its dependence on foreign sources.

Since the War of German Reunification, the Bavarians of Heidelshemat have been wrestling with the issue of whether or not to join the other Bavarian colonies and accept German control. There is also the increasing friction with the Texan colony over control of the resource-rich islands between the two colonies.

## THE TEXAN COLONY

UCP: C564623-9 Ri 3 0

*Colony Name:* Alamo

*Nationality:* Texan

The year 2244 saw the arrival of a Texan expedition and the establishment of a Texan outpost on a continent well away from the one that the Bavarians settled on. Intending the outpost to be a stepping stone to the 82 Eridani System (still unexplored), the Texans moved in without giving the Bavarians much advanced notice, nor even really asking their permission. Although the Bavarians had no legitimate reason for trying to keep the Texans off Heidelshemat, the fact of the Texans moving in so blithely without consulting the Bavarians left a bad feeling in the minds of many of the Bavarian colonists. Consequently, the Bavarian colony does its best to keep contact with the Texans to the barest minimum.

## THE INCAN COLONY

UCP: C552658-8 Ri 1 0

*Colony Name:* Machu Picchu

*Nationality:* Incan

The first Incan pre-colonisation expedition arrived in 2280. Ill-equipped to perform much in the way of useful surveys, the Incas found that they had to call on the Texans for equipment and aid. The Texans provided both on the condition that such assistance was temporary. The Incas set about selecting a site

## EBER RUINS

In 2253, a group of Texan explorers scouting out the region to the south of their outpost discovered what appeared to be ruins of a sentient culture. Although the remains on the ground were little more than rubble orbital surveys showed recognisably artificial foundation patterns. Further research and comparison with the ruins on Daikoku, showed the Rho Eridani ruins to have been built by the same culture: the Eber.

Although the ruins were demonstrably Eber, there are marked differences between the Daikou and Rho Eridani sites, most notably in the layout and the artefacts so far discovered. The current hypothesis is that the two worlds were settled by different Eber groups, perhaps different nations

for their colony (in an area well to the north of the Texan colony) and, by 2285, they had begun work on some facilities for it. In building their colony, which was formally established in 2289 (even though at this time, it was little more than an outpost with a large spaceport), the Incas relied heavily on the Texans for technical support. The Texans grudgingly acquiesced, although the common sentiment was that the Incas should be able to do the work themselves. The Incas felt betrayed by this sentiment, as Texas had originally offered support to the fledgling Incan program. This engendered hard feelings in both camps, leading to a state of hostility between the two colonies today. The Incas are leaning towards the Heidelshematians for support, which the German colony is happy to provide.

*Character Notes:* The Thin air DNA modification is standard for both the German and Texan colonies. The Incans, however, are better acclimatised to higher altitudes and so most of them simply have the Standard Colonist DNA modification.

Heidelshemat is a Low Gravity World.

## CHENGDU

UWP: B897745-B

## SYSTEM DATA

*Primary Name:* Epsilon Indi

*X, Y, Z Coordinates:* 5.2, -3.1, -9.4

Chengdu is similar to Earth in many ways, however the land is more rugged and the weather is more temperate. Although the world has a somewhat higher gravity than Earth and is somewhat cooler, it has a great deal of potential as a colony and a provider of resources for the sponsoring nations and foundations. The presence of free organic radicals in the atmosphere constitutes a minor taint but one that is easily handled by Filtration Symbiotes or filter masks.

## COLONY DATA

UCP: B775745-B Ri, In 2 0

Colony Name: Chengdu

Nationality: Manchuria, Canada, Nigeria, Life Foundation

Colonisation of Chengdu occurred in two phases. The first phase, centred on what is now the city of Anyou, was dedicated to resource exploitation and at first did not include industry or farming. The second phase, centred on the city of Shaoguan, was jointly sponsored by the Manchurian government and the Life Foundation, along with participation by both Canada and Nigeria. It took longer to organise and it was not until 2241 that the first settlement ships arrived. This second phase of the colonisation effort was aimed at providing the more tangible elements of a successful community, such as a university, along with manufacturing and farming.

After 112 years, the colony is fully self-sufficient and has an economy equal to most Tier 3 nations. There is a large independence movement, which has led to large demonstrations on several occasions. However, Manchuria is not about to let go of its most successful colony and only the presence of Canadian and Nigerian nationals has prevented the Manchurian colonial government from cracking down harshly on the independence movement. Even so, there are numerous stories of pro-inde-

pendence people 'disappearing' or being arrested by Manchurian authorities.

Despite the occasional heavy-handedness of the Manchurians, the colonies are known for their relatively open governments, particularly when compared to other Manchurian colonies.

**Character Notes:** The Standard Colonist DNA modification is typical for most of Chengdu's inhabitants.

Chengdu is a Normal Gravity World.

## KANATA

UWP: D848545-8

## SYSTEM DATA

Primary Name: DM+20 5046 (Doris)

X, Y, Z Coordinates: 19.6, -12.1, 8.8

The Nereids ring system is a dense, stony ring, with an anomalous origin, as it is outside the Roche limit for Kanata. The largest object in the ring is a two kilometre juggernaut named Ellesmere. This rock serves as Kanata's orbital terminal.

Planetary old age, coupled with the lack of any significant tidal stresses, has left Kanata's core in a solid state. Danger to the colonists arises from this condition, as Kanata cannot generate

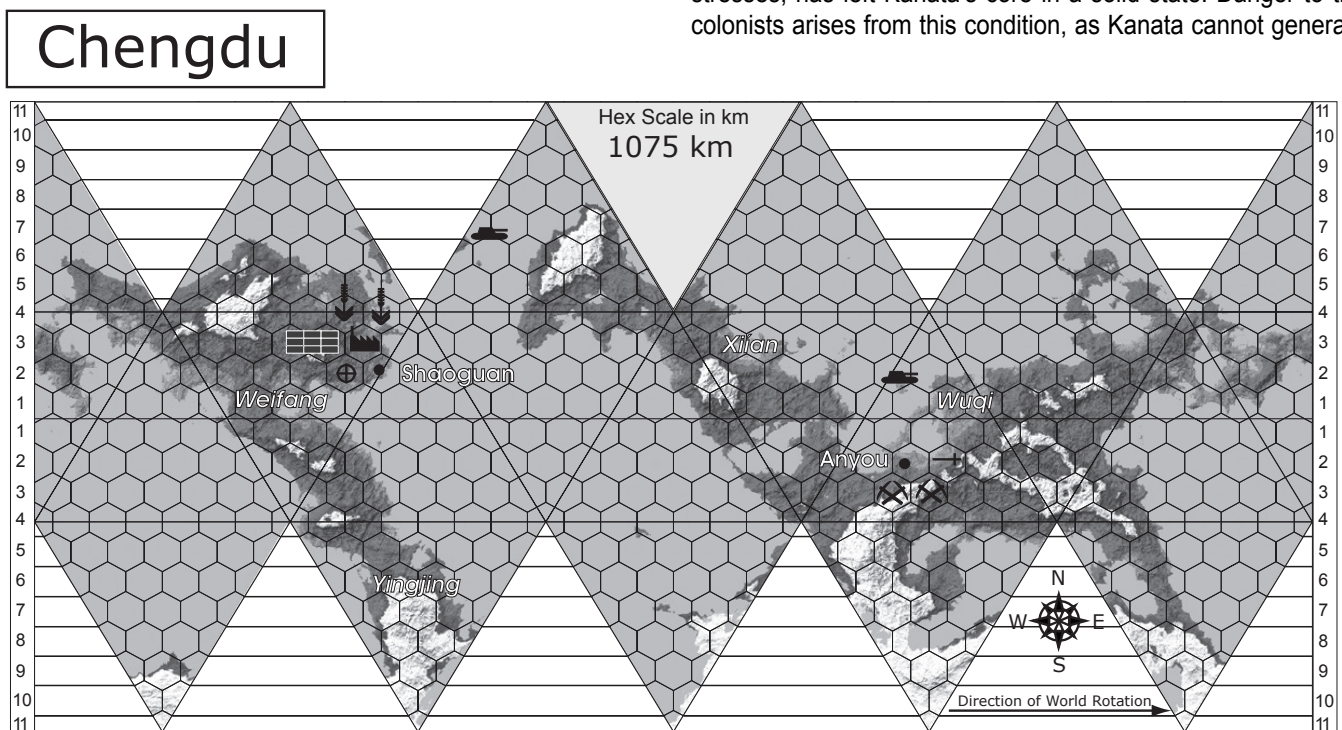

### Legend

- Major City
- ⊕ Spaceport
- Catapult
- ⚡ Mining
- 🌾 Farming
- 🚒 Military Base
- ⚡ Fusion Plant
- ☀️ Solar Power Rectenna
- 🏭 Heavy Industry

a magnetic field to trap outbursts of high-energy particles given off by stellar flares. In the 27 years since colonisation, there have been six major stellar flares. The radiation levels rise dangerously on such occasions.

In addition to the complex coastline biosystem, with its mats of vegetation that gradually transition from deep-water to shoreline, Kanata presents a Terra-like complexity of variety of environments inland. Some 20 percent of its land surface is covered by the desert and tundra of the equatorial regions. These areas are characterized by a large number of impact craters spread across the surface. Many of these have become lakes but others have become remarkable havens for a wide variety of life. With spring-fed pools at their bottoms and their walls covered with a mat of intertwined vegetation, they are like little jungles in the tundra. A two-man team has been lost to unknown hazards in one such 'crater garden'. There are indications that these gardens are the product of some ancient intelligence, left to run rampant.

### COLONY DATA

UCP: D446545-8 Ri 4 0

Colony Name: Kanata

Nationality: Canadian

The Canadian colony at Kanata has brought the nation the respect and prestige it was looking for and the resources available on this distant world suggest that the investment will also pay off economically.

Kanata's resources have been the source of the only unrest in the colonies, as independent prospectors and the major corporations square off against each other. This has usually resulted in victory for the independents, although there is some pressure being brought to bear on the government in Ottawa to relax restrictions on the corporations.

*Character Notes:* The Kanata DNA modification is required for anyone spending any amount of time on this world.

Kanata is a Normal Gravity World

### KWANTUNG

UWP: B667775-B

### SYSTEM DATA

Primary Name: Tau Ceti

X, Y, Z Coordinates: 10.1, 4.8, -3.3

Kwantung is a wealthy planet with abundant mineral reserves. Agriculture is difficult, however, due to a micro-organism that fixes nitrogen into a form that is unusable by Terran plants. Thus farming got off to a slow start until plant-life could be engineered to deal with conditions on this distant world. One of the side-effects of this problem is that there are no diseases or parasites on this world that attack humans or their animals, although the engineered plants are susceptible.

### MANCHURIAN COLONY DATA

UCP: B655745-B Ri In 2 0

Colony Name: Kwantung

Nationality: Manchurian

# Kwangtung

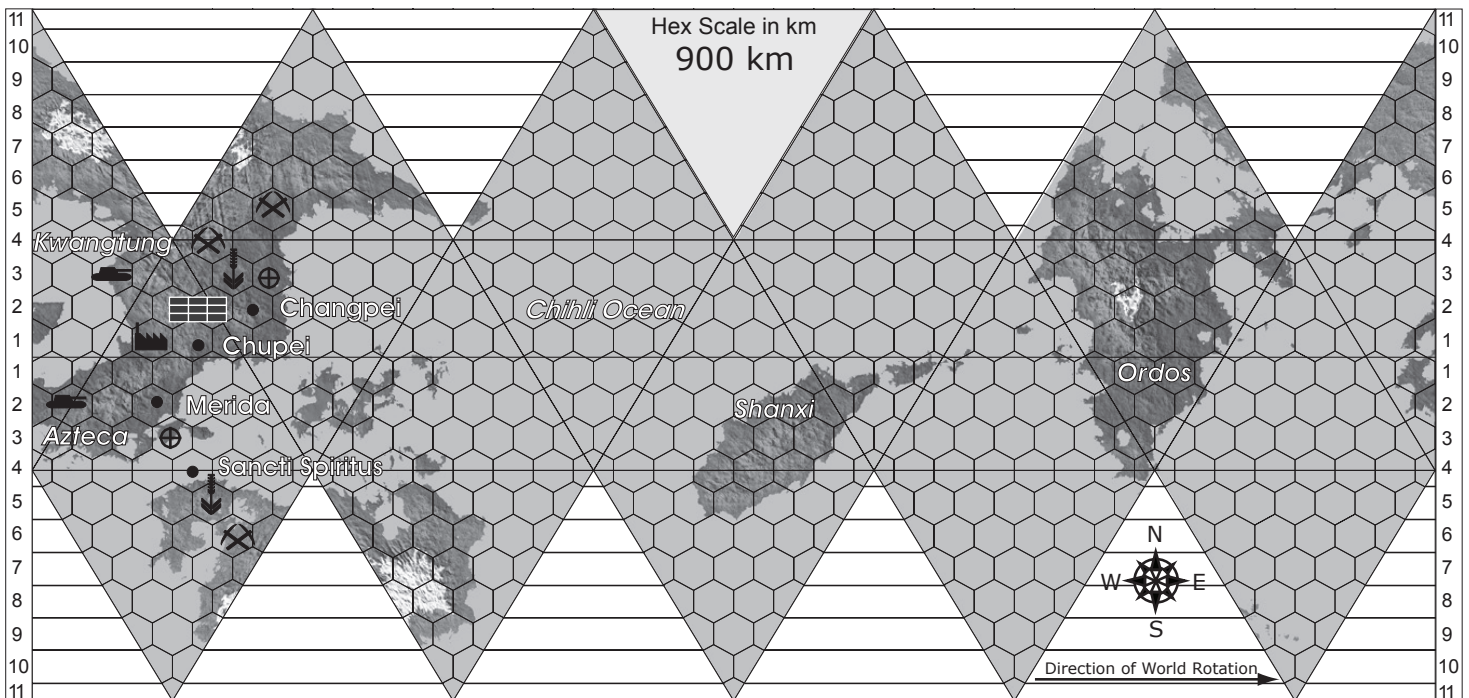

Kwantung is fully self-supporting and exports many items to younger colonies in the Chinese Arm. Metals and machinery are the single largest export items, with rum, art objects and clothing making up another large portion.

Kwantung was first settled by the Manchurians, whose policy of using drafted convicts for labour led to a serious crisis within the young colony. The outcome of the crisis led to the colony being granted an unusual degree of autonomy and democratic government, matched only by Chengdu amongst Manchurian colonies. In fact, the local council has to be consulted on all matters relating to the colony and even has the ability to stall or block Manchurian plans and proposals.

**MEXICAN COLONY DATA**

UCP: C674645-A Ri 3 0

Colony Name: Azteca

Nationality: Mexico

Population: 3.5 million

In 2258, when Mexico approached the Manchurians about setting up a colony on Kwantung, the local council intervened, saying they wanted only an agricultural colony to share the world with them, as the world's unusual agricultural conditions and the Manchurian's emphasis on mining had made the need for more agricultural production quite acute. Mexico, however, wanted a mining colony, as minerals were what they needed, not produce. Eventually, a compromise was reached, allowing the Mexicans to settle on the condition that 20% of the colony's output be agricultural. Mexico agreed and set up a colony in 2263.

At first, there was considerable wariness between the 'old' colonists and the Mexican colonists. To a large extent, this was due to the differences between Manchu Chinese and Mexican cultures. The newcomers soon proved themselves to be a hard-working and helpful addition to the planetary economy. The additional effort in agriculture soon turned the planet from a net food importing planet to an exporting planet.

*Character Notes:* Kwangtung is a pleasant enough world that DNA modifications are not required. However, the Standard colonist DNAm package is very common, especially with the Mexicans.

Kwangtung is a Normal Gravity World

**DUKOU**

UWP: BA8A51A-8

**SYSTEM DATA**

Primary Name: Epsilon Eridani

X, Y, Z Coordinates: 6.4, 8.4, -1.9

The first planet of Epsilon Eridani, although inhabitable, is only marginal and would never have been settled were it not for an incredible discovery beneath the thick mantle of ice that sheathes the world. Pai-leng, a pseudo-fungus, was found to have remarkable antibiotic properties, more potent than any of the Terran-derived varieties in use. Otherwise, it is a bleak and frozen place.

**Dukou**

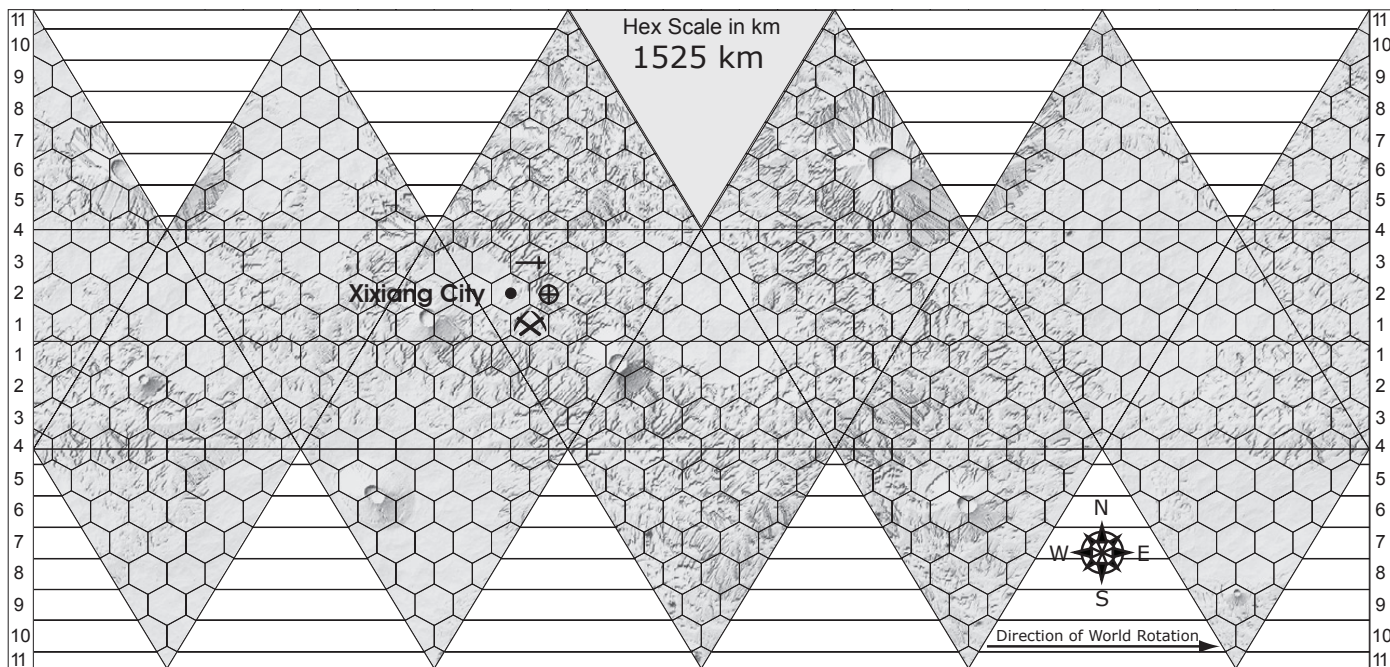

## A STRANGE SORT OF FROG

Quite possibly one of the oddest-looking creatures on any colony world, *el alto rana* (tall frog) is a vaguely frog-like beast more massive than an African elephant, with a tall, thin neck that can reach over 15 metres. Its name comes from the batrachian look of its wide-mouthed, pop-eyed head.

## COLONY DATA

UCP: B42751A-8 Po NAg

Colony Name: Xixiang

Nationality: Manchurian

Originally settled as a penal colony to exploit the pai-leng, Xixiang is no longer accepting convicts to work the mines and the high pay attracts many workers from off-world. The bitter cold, the endless expanses of ice and snow and the oppressive gravity make this world truly unpleasant. Dukou has one of the highest suicide rates in human space.

The colony itself is made up of a series of buildings all connected by tubular passageways. The passages are included to avoid constant exposure to the harsh temperature. The exceptions to this rule are some of the newer pai-leng mine installations, which are located too far away from the original facility to make these connections practical. Workers commute to and from these installations on winter-adapted trains.

**Character Notes:** Dukou is a cold, unpleasant world. The original convict labour was not given any sort of DNA modification, although their descendants and the more recent colonists almost always go with the Cold Weather DNA modification.

Dukou is a High Gravity World

## MONTANA

UWP: C769643-9

## SYSTEM DATA

Primary Name: Omicron 2 Eridani

X, Y, Z Coordinates: 7.0, 14.0, -2.2

**Native Life:** The majority of native animals are small and cold-blooded, diurnal in habits and hibernating in cold weather. A few large carnivores can be dangerous to humans if disturbed but none will hunt humans by choice. Although the local animal life is digestible, it is unpalatable to most and Terran livestock is the preferred food source.

Montana is a rugged, tectonically-active world. The land masses, such as they are, are the peaks of submerged mountains jutting out from the vast ocean, thus the world's name. Flat areas are rare and tend to only occur in river valleys and flood plains. The location of the colony is a plateau on the northern part of the largest continent-island. Ironically, given that Montana is practically a water world, the colony is entirely land-locked.

## COLONIAL DATA

UCP: C565643-9 NI, Ag

Nationality: Mexican, Argentinean

The dynamics of colonisation on Montana created a situation where men outnumber women by about three to one. The situation is beginning to even out as the colony matures, however, the problem still exists and has led to an unusual solution: polyandry or multiple husbands for one wife. This has some additional benefits, like being able to bring more hands to bear on work and ensures that children will not be orphaned by a sudden accident. This solution flies in the face of the normal

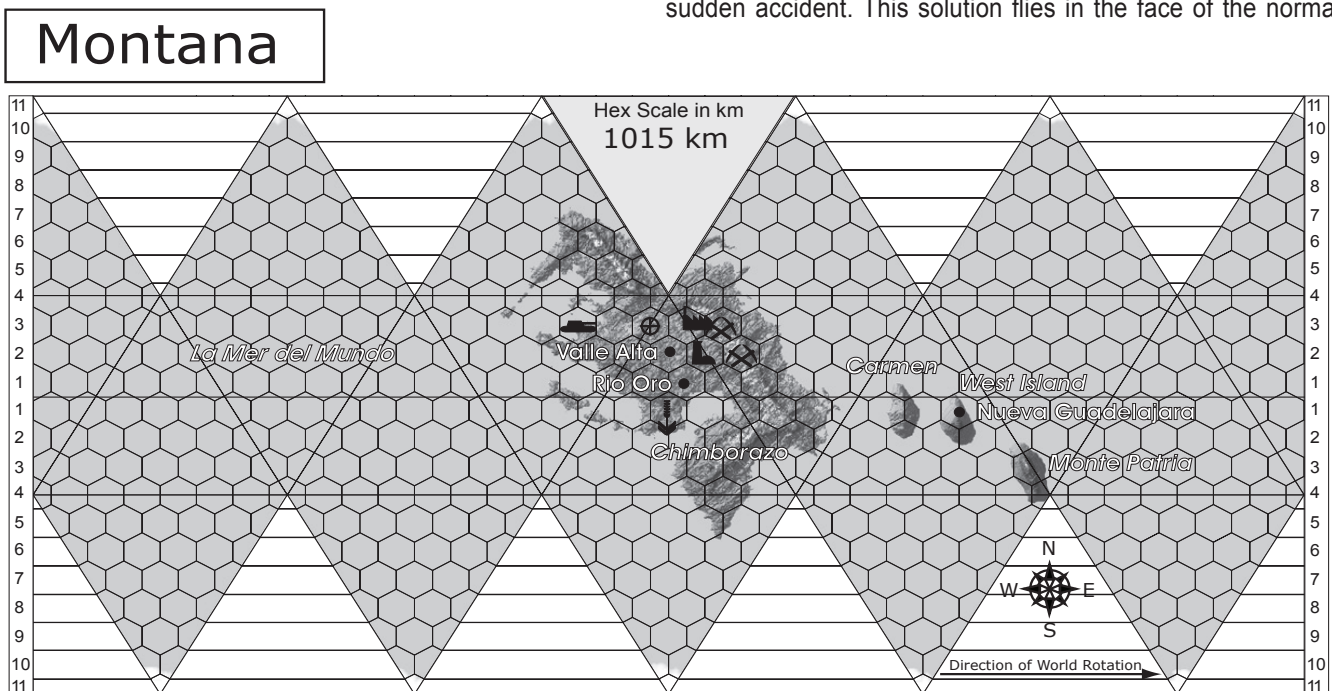

colonial conservatism but was the only choice for the first-generation colonists. The current generation, often brought up in these homes, is starting to lean towards group marriages, which have all the benefits of polyandry for a more even gender distribution. Needless to say, the Church is horrified by these trends but can do little to stop them.

While Argentina and Mexico originally placed two separate colonies within cooperating distance of each other, the distinctions have long since vanished. Even newcomers to the colony sense that planetary – and not merely colonial – attitudes prevail. Three major cities have grown up: two near the fusion plant, in the area of the original colonies and one on West Island, where a university has been started by the Life Foundation.

*Character Notes:* The Standard colonist package is in widespread use on Montana. Interestingly, in recent years the gender change DNA modification has been used by some to narrow the gender gap, although with the disapproval of the Church.

Montana is a Normal Gravity World

## AUSTIN'S WORLD

UWP: C989674-8

### SYSTEM DATA

Primary Name: DM-3 1123

Spectral Class: M1 V

X, Y, Z Coordinates: 2.5, 18.9, -1.3

### RELIGION IN THE COLONIES

On many colony worlds, religion serves a two-fold purpose. One is the purely religious but the other and often more important, purpose is social. In many small communities, the church has once again become the social centre, with dinners, dances and socials providing a means for neighbours to get to know one another. Religion in remote areas tends to more ecumenical also, with the question of denomination or even faith, seldom coming up.

Austin's World has an extreme axial tilt of almost 90°. This has the planet passing from pointing one pole at the sun for several days at a time, as it swings around to point the other pole at the sun. The uneven heating of the opposite poles produces violent winds that shift directions approximately every 20 days, with frequent heavy rains. The slightly thick atmosphere packs a lot of kinetic energy and can flatten transplanted Terran crops or trees in unprotected areas.

All forms of Austinian sea life are edible by humans, although some are scarcely palatable. The aforementioned seaweed is the tastiest of the vegetables and visitors to the world have spoken highly of one of the bottom-feeders. Colonists, especially of the Life Foundation, have learned to relish most of the possible foods from the sea. However, the only source of vitamin C is Earth fruits.

Most agriculture is carried out in heavily-built greenhouses and utilises soil that has been enriched with Terran bacteria. Orchards are shielded by rock walls in all directions, so the landscape from the air looks like a set of postal cubbyholes. Grains and other grasses have been engineered to have shorter, stronger stems to survive the occasional cold spells and high winds.

# Austin's World

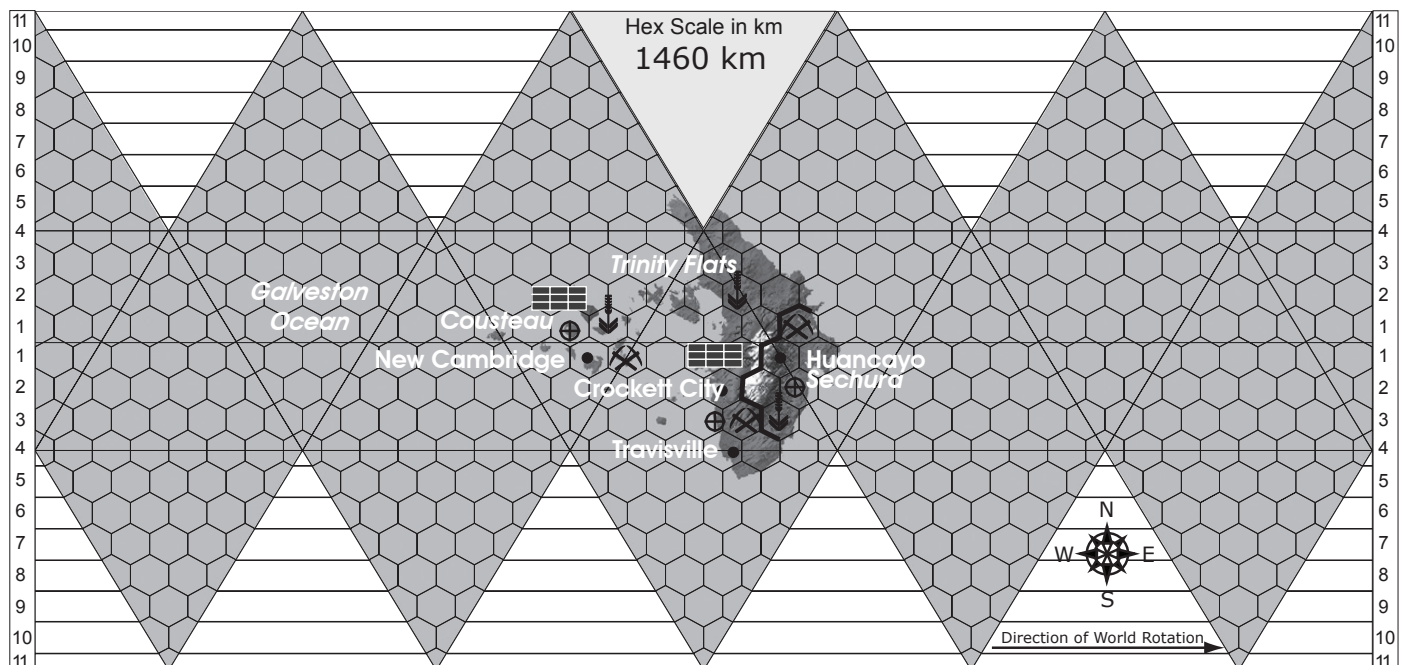

---

## DAY OR NIGHT

The day/night cycle on Austin's World is quite variable and it is extremely difficult for people to adapt their circadian rhythms to this world. As a result, the colonists use a great deal of artificial light and create their own schedules, often around a 28 hour cycle.

---

## THE LIFE FOUNDATION COLONY

UCP: D479520-9 Ri

Colony Name: Cousteau

Nationality: Life Foundation

The Life Foundation Colony is located in the islands off the coast of New Travis, several hundred kilometres from the Texan and Incan colonies. It is the first full colony constructed by the Life Foundation, although they have several outposts and enclaves across human space. It was constructed as an experiment in ocean living and farming techniques and is currently involved in trials for new technologies and methods for the Haifeng outpost, which is slated for expansion in the next few years.

One of the most interesting experiments being conducted at Cousteau is the use of a Demarchist form of government. Demarchism is an absolute electronic democracy. A large segment of the population, known as the Planning Group, has been outfitted with neural implants that allow them to instantly access and vote, on all decisions affecting the colony. Major issues are put to all of the colony's citizens over the age of 15.

The Foundation services the entire planet's population from its powersat, transmitting to an island rectenna. They are on amicable terms with everyone and try to stay strictly out of politics, whether based on Earth prejudices or colonial problems. They regard the entire ocean as their domain, which is a lot of territory but they will allow equal access to it if conservation rules are observed. They would resist any effort of one colony to deny another colony use of the ocean and its products.

In 2295, 75 uplifted dolphins arrived from Earth and were settled into a sheltered bay near Cousteau. Since then, the u-fins have been learning how to adapt to their new home.

## THE TEXAS COLONY

UCP: B764643-8 Ri

Colony Name: Trinity Flats

Nationality: Texan

Texan colonists are spread along the western coastal plain of the world's one continent. Two major population centres, Travisville and Crockett City, house heavy industry and orbital interface facilities. Much of this industry relies on imported equipment since there are few metals suitable for making factory machinery on Austin's World. A power network distributes electricity from the Lifers' powersat and from several small hydroelectric

dams. The orbital catapult lies directly on the equator. A sizeable ground terminal has been built to accommodate freight awaiting shipment. Treaties with the Incan Republic and the Life Foundation guarantee access to the orbital facilities.

Trinity Flats is known for its growing beef exports to other worlds along the Chinese Arm.

## THE INCAN COLONY

UCP: D63345A-6 Ag,NI

Colony Name: Sechura

Nationality: Inca Republic

The Incans inhabit the highlands and valleys in the centre of New Tarrant. Snow and ice are not unknown here. Roads to connect the valleys have been constructed and a power net, with huge arrays of solar cells, supplies some of the power, the rest being purchased from the powersat. The major trade items produced here are minerals for fertiliser and the chemical industries, along with light element ores, used for export to Earth as well as being an on-planet trade item. Like many new colonies, the Incans make extensive use of animal power, which exist alongside Link phones and hydrogen-power heavy machinery.

*Character Notes:* The majority of the colonists on Austin's World have the Standard Colonial modification. However, about 15% of the Life Foundation colonists have the Merman modification, while nearly 40% of the Incan colonists have no modifications at all.

Austin's World is a High Gravity world

## PAULO

UWP: C967645-8

## SYSTEM DATA

Primary Name: Procyon A

X, Y, Z Coordinates: -4.7, 10.3, 1.0

*Notable Planets:* Paulo is actually part of a double-planet system, with it and its partner Pedro orbiting each other. Pedro is nearly equal to Paulo in mass, yet lacks any sort of appreciable atmosphere.

## PLANETARY DATA

The double-planet system of Pedro and Paulo orbit their common centre of mass with a 42-day period, which the colonists of Paulo have adopted as their equivalent of a month. Each month, therefore, the twin planets take turns blanketing each other with an eclipse of considerable duration. Pedro appears about as large as Luna from Terra and, at 3.5 AU, it covers almost twice a much sky as Procyon A.

Life on Paulo evolved utilising dextro amino acids, thus leaving it of no nutritional value to any Earth-born entity. The planet's environs hold analogues to both terrestrial plant and animal life, in environs ranging from the deepest oceans, to the polar tundras and the tropical peaks. Life forms such as the notorious *gattinhos de seva*, a cunning predator that makes its home in the temperate forests and mountains, running down its prey in shifts from their large peaks, to the famous *andeadores*, the talking trees that can uproot themselves and slowly stalk across the forest floor, end over end, until they find better soil.

Paulo is a rich, vital world, which stands it in direct contrast to the other half of the twin planet system, Pedro, a barren, lifeless rockball. Brazil had hoped that Pedro would find a use as a mining location but the country has not yet had the resources to follow-up on that idea.

**COLONIAL DATA**

UCP: D864645-8 Ag 1 0

Colony Name: Paulo

Nationality: Brazil

The citizens of the Brazilian colony of Paulo are taught to be extremely loyal to their mother country. Everywhere one looks, the Brazilian flag is flown and children are taught national songs in school. The new, elected planetary government operates on guidelines from Earth, with a constitution that is a virtual carbon copy of Brazil's. Paulo's government is represented in the Congress on Earth and was granted statehood in 2299 when the population exceeded a million people. Brazil hopes to avoid

the difficulties other nations have experienced with colonies making a bid for autonomy. However, human nature may be expected to interfere with this carefully developed plan after a few generations.

Despite the head tax paid to Brazil and some onerous trade restrictions, life on Paulo is quite satisfying for most of the colonists. A few, however, have recently begun illegal trading with Libertine trader captains, selling the more exotic foods and biologicals in exchange for off-world luxuries. This illegal trade has come to the attention of pirates and raiders, who are manoeuvring to get a share of the lucrative cargos.

*Character Notes:* Due the possible dangers from wildlife and Pedro-caused quakes, the Brazilian government made an extra investment in the Paulo colonists and ensured that everyone received the Rapid Response DNA modification. All characters native to Paulo must spend their first term as a Colonist. After that, they can switch to a different career.

Paulo is a Normal Gravity World

**ENCLAVES**

Two of the three alien homeworlds in the Chinese Arm have small human populations, while the third, the Xiang moon, is retained as a preserve, without a permanent human population.

**KORMORAN**

Both the Texans and the United Arab Republic have enclaves on Kormoran.

**Paulo**

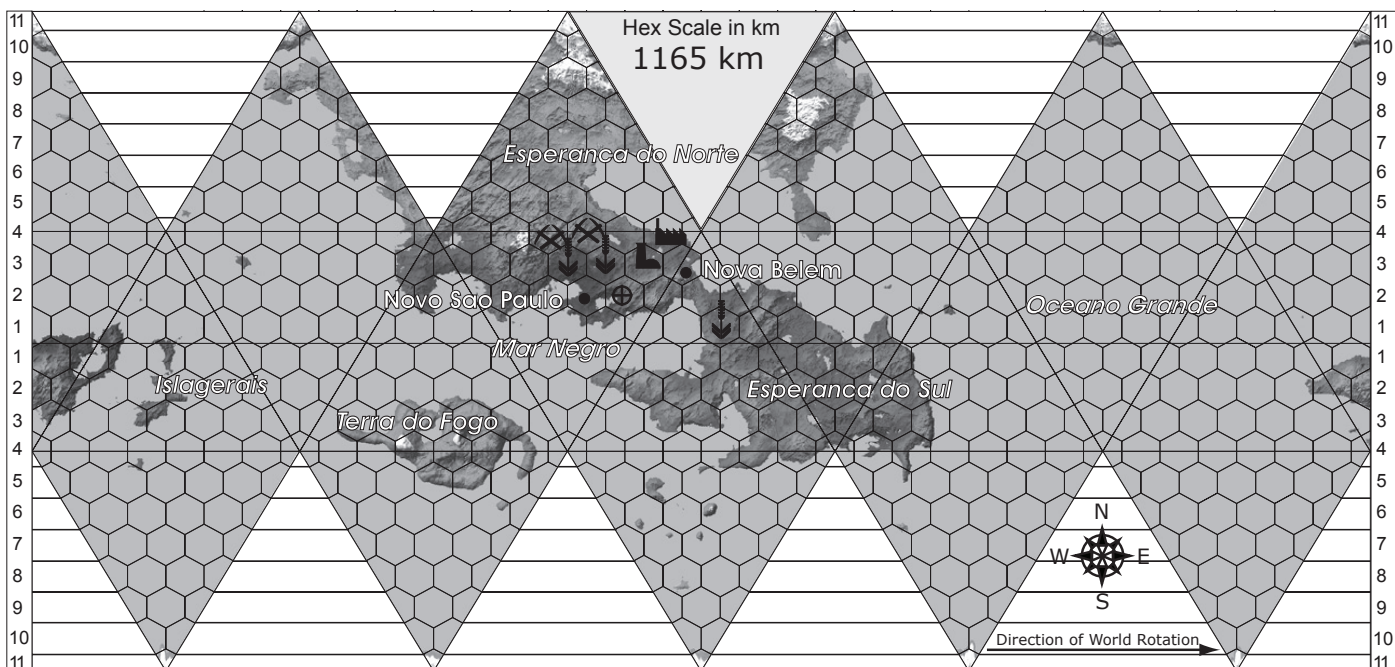



## UNITED ARAB REPUBLIC ENCLAVE

UCP: C129365-8 6 0

The UAR enclave is a trade delegation in the midst of Kormoran's largest city, called F-flat-C by the Eber and el-Madina el-Adima (Old City) by the UAR delegates.

The 6,000 or so traders and governmental representatives have the ears of the local civilised Ebers and some relatively simple technology transfers have greatly bolstered their position. They resent the Texan presence on the world, however, despite the success of their venture.

## THE TEXAN ENCLAVE

UCP: X523443-9 8 0 Ag

Colony Name: New Austin

The Texans view their holdings on Kormoran as more of a colony and are developing it that way. Although stuck out in the desert by the UAR and their Manchurian allies, they have persevered and even prospered. They have agreements and treaties with several of the nomadic Eber tribes close to their settlement and there is a brisk trade between humans and Ebers.

The Texan enclave currently boasts a population of over 80,000. Despite the settlement being deep in the desert, Texan deep wells and directed irrigation make the land the most productive on the planet, with Texan agricultural products becoming much sought after on the tables of Kormoran's Eber elite.

## STARK

Stark is the homeworld of the Sung and is heavily urbanised to support the large Sung population. As part of the reparations after the Slaver War, the Sung Akcheetoon nation provided land and material for the Canadian and Manchurian victors of the war.

## THE CANADIAN ENCLAVE

UCP: X099466-C 1

The Canadians decided to put their enclave in the middle of the Akcheetoon capital city, Sosorra. Five of the Sung super-sky-scrapers serve as home and office to the Canadian diplomats and scientists, housing the 7,000 members with room to spare. The largest of the buildings is a full 500 stories tall, with the floors sized for a human.

A full company of troops provide security for the enclave but there has been very little trouble since the conquest of the Akcheetoons. The Canadian Parliament is discussing replacing these troops with conventional RCMP forces but that decision is still months away.

Sosorra is in a temperate climate, on a sea coast with mountains inland and is a very popular diplomatic posting.

On the whole, the Canadian Enclave enjoys very good relations with the Sung, although there is low-level but growing, unrest with the pace of technology transfers between the humans and the Sung. Sos'soon'atkachar demands that the uplifting of the losers by the winners takes place in a timely fashion. It has been over 40 years since the Slaver War and the Sung still cannot build their own star ships.

# Kormoran

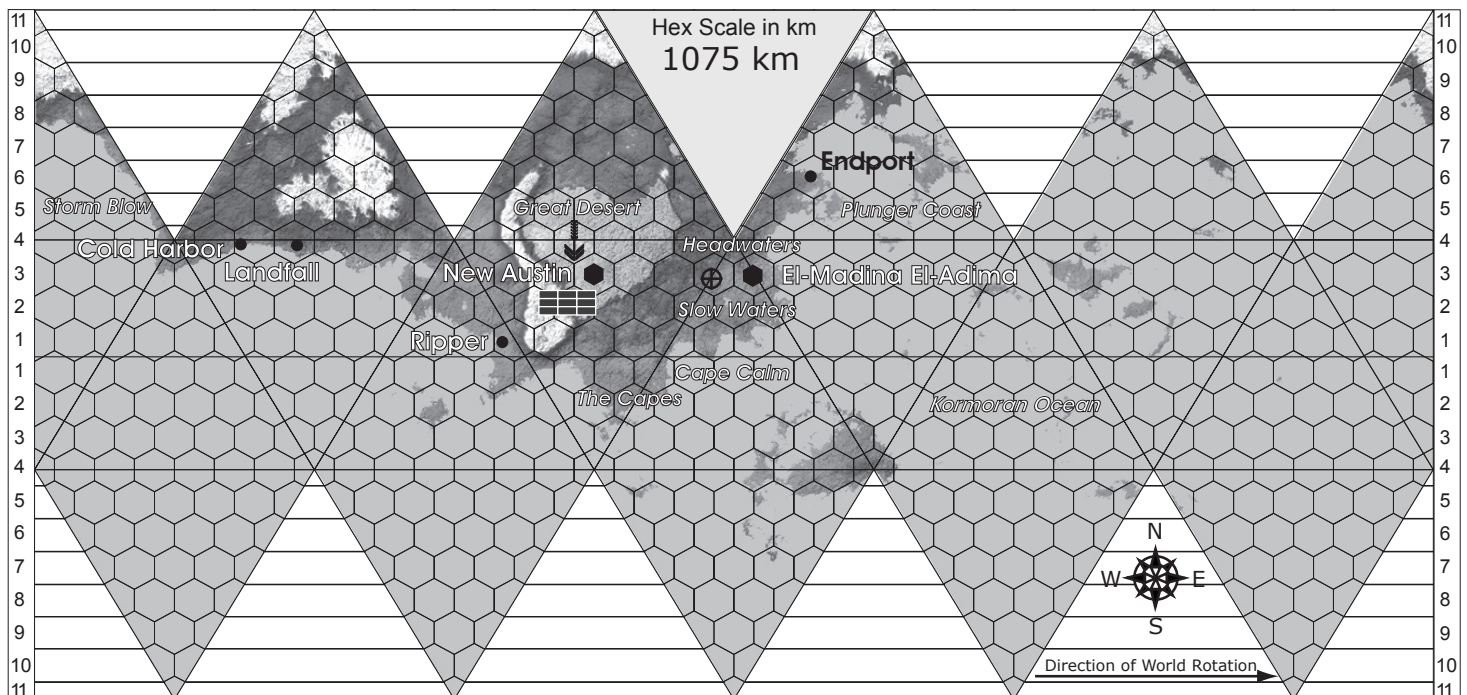

## THE MANCHURIAN ENCLAVE

UCP: C099467-C 2

The Manchurian Enclave, on the other hand, is in the middle of a wilderness area and is constructed more like a fort than an embassy. The Manchurians maintain their own spaceport facilities on the grounds of the enclave and keep at least two companies of troops as security. There have been a few incidents at the Manchurian enclave, mostly arising out of environmental protests at the Manchurian's choice of location, in the middle of what is effectively a national park.

The Manchurians seem to be less of a focus for resentment over Sos'soon'atkachar payments than the Canadian enclave, possibly due to its more remote location, far from any major city or even any substantial town. Additionally, the Manchurian approach of demanding payments for any technology transfer is more in line with Sung cultural expectations under Sos'soon'atkachar.

## EXPLORATORY WORLDS

### **Eriksson**

UWP: X745100-0

#### STELLAR DATA

Primary Name: AC +17 534-105

X, Y, Z Coordinates: 15.9, -12.6, 6.3

### **ECONOMIC HEARTBREAK**

With rumours coming in of a possible closure of the Texan settlement, the local population is considering trying to go it alone as an independent colony. This may be possible but would entail great hardship for the settlers.

Eriksson is a pleasant world, if a little cooler than Kanata. Much of the world's water is locked up in the large darkside icecap. This small world is tidally-locked to its primary and orbits quite closely. This makes it susceptible to flare activity but the red dwarf star it orbits seems to be unusually stable. The planet's magnetic field would help attenuate any radiation but being on the surface during a flare would be dangerous.

Of particular interest on Eriksson is a colossal patch of melted and scorched rock close to the centre of the dayside. The origin of this 1,200 kilometre diameter scar is unknown but most theories involve it being left by a particularly energetic flare. If the research is correct, then that event likely came close to exterminating all life on this small world.

### **Haifeng**

UWP: X76A000-0

Almost entirely covered by water, this world has baffled Manchurian planners for decades. There are resources there but exploiting them would require a different approach than on any other Manchurian colony.

#### STELLAR DATA

Primary Name: L 1159-16

X, Y, Z Coordinates: 13.0, 7.3, 3.3

## Eriksson

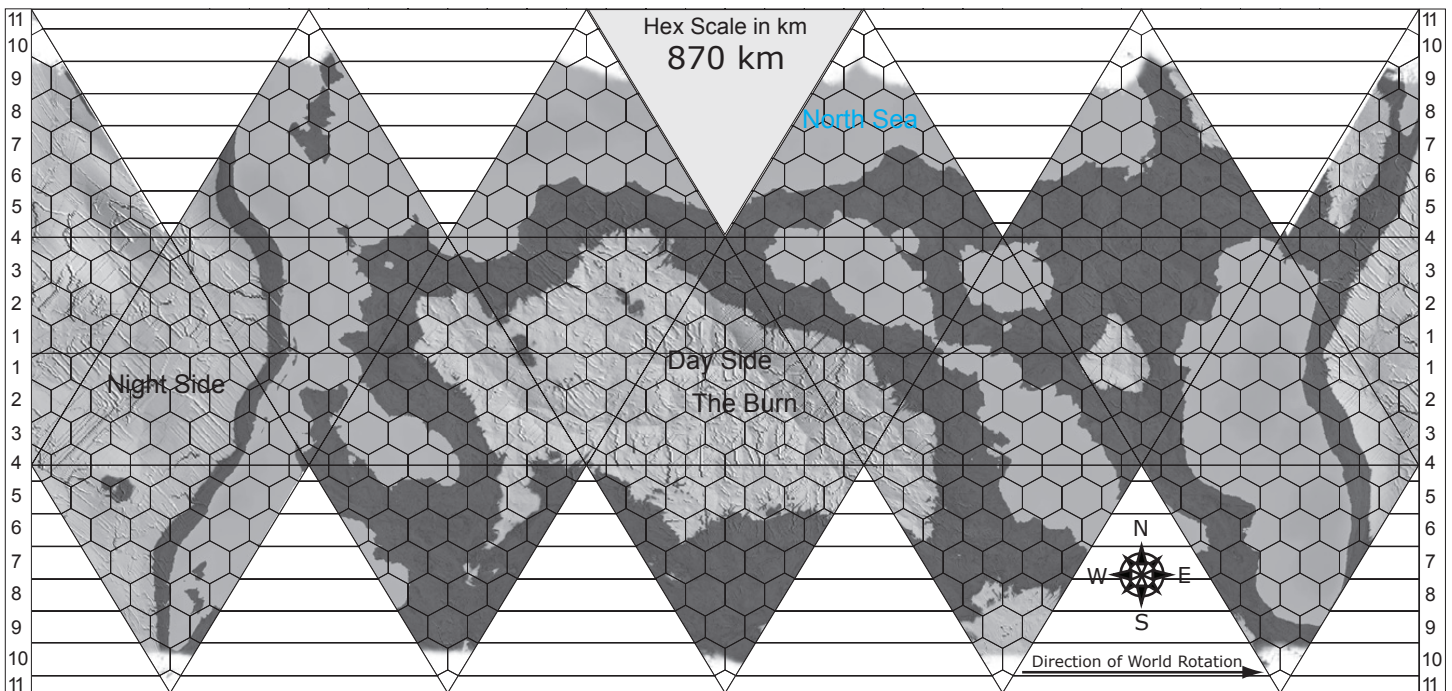

Haifeng is almost completely covered by deep oceans, which range down to 30 kilometres in depth in places. The few scattered islands are all volcanic in origin, with the largest group being scarcely larger than the Hawaiian Island chain on Earth. Many of the volcanoes are still active. This tidally-locked world orbits close to its primary and the temperature differential between the hot and cold sides of the planet keep a steady stream of hurricane-sized storms blowing across the equatorial regions from the cold side to the hot side. The polar latitudes are relatively free of such major storms, although they do get a few per year. The high atmospheric pressure is partly responsible for the world's surface temperature, despite the anaemic star it orbits. The dense atmosphere also provides some flare protection.

The waters of Haifeng are fresh enough to drink and indeed one of the major problems with colonisation on this world would be a lack of some of the critical salts needed to sustain terrestrial life. The plant and animal life is quite edible, although in addition to the mineral supplements some vitamin supplements are required. The native life is equally capable of eating terrestrial life and, in the case of some of the larger ocean predators, is fully capable of eating the ship that life happens to be sitting on.

# Haifeng

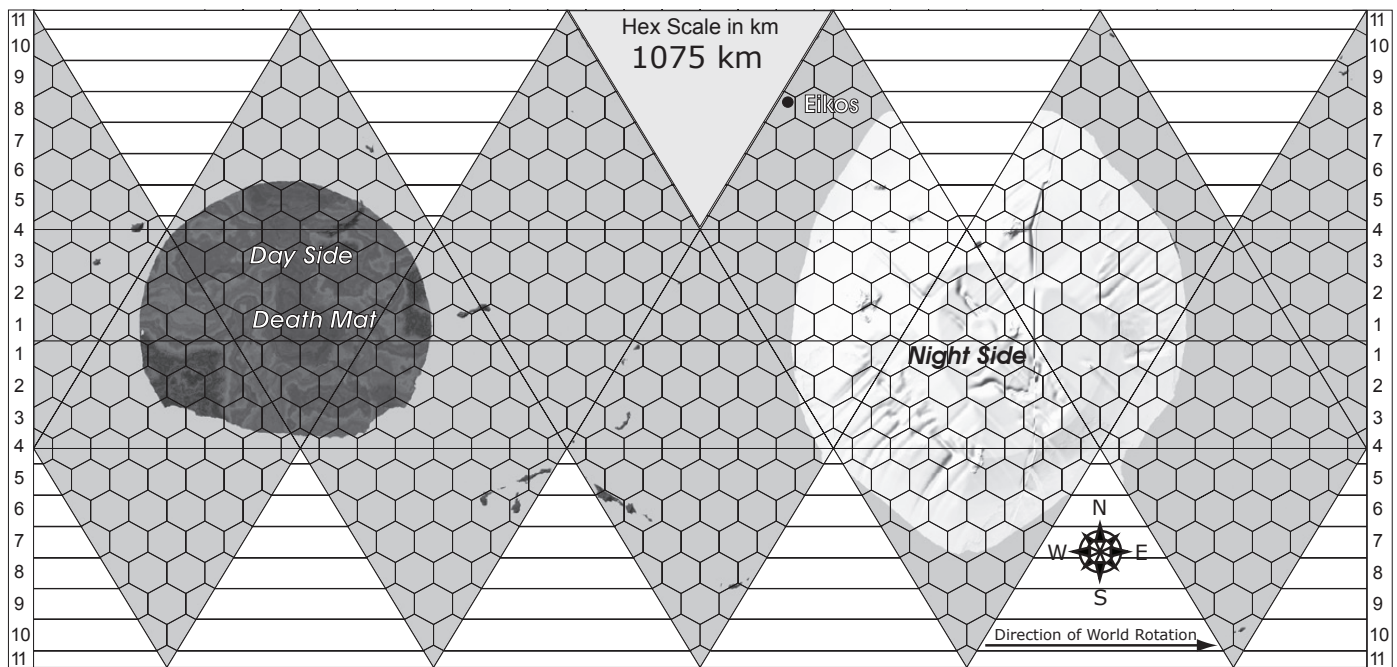

## Legend

- Major City
- ⊕ Spaceport
- Catapult
- ⚡ Mining
- ⬇ Farming
- 🏠 Military Base
- 🏭 Fusion Plant
- ☀️ Solar Power Rectenna
- 🏭 Heavy Industry

# FOUNDATIONS, CORPORATIONS AND TERRORISTS

## FOUNDATIONS

The Foundations are not governments, yet they fulfil governmental responsibilities in some places and for some people. They are independent and well-financed, yet rely on public support and public opinion to perform their role. Foundations are rigorously administered to ensure that they perform their tasks correctly and their finances are a matter of public record. Public trust for the Foundations is high, as even those with agendas have obvious and popular ones.

Some Foundations support research, while other supports colonisation efforts. Some are public service organisations, while others have clearly stated nationalist goals.

## THE MAJOR FOUNDATIONS

Foundations and their activities cover the entire spectrum of human activity. The background, interests and motivations of each foundation vary greatly.

### **ASTRONOMISCHEN RECHEN-INSTITUT**

*Headquarters:* Heidelberg, Germany, Earth, Sol, Core.

*Mission Statement:* The pursuit of pure research into stars, planets and astronomical processes.

*Products/Services:* Knowledge, colonial surveys, starship design.

*Language(s):* English, French, German.

*Culture:* Open, similar to a university.

*Staff Levels:* 42,000 + students and interns (50,000+).

*Scope of Operations:* Primarily the French Arm, along with distant expeditions

The Bavarian *Astronomischen Rechen-Institut* was originally part of the University of Heidelberg. Endowed by Azania with tantulum and funding to support a squadron of interstellar scouts, the ARI is a foundation pursuing pure research into the nature of stars and their planetary systems.

The ARI sponsors exploratory missions to strange star systems and phenomena. Most of these are directed at the immediate Frontier systems but there are several expeditions operating beyond 50 light-years from Sol, some of which are not expected to return for more than a decade. One of these, the *Swabia* is feared lost after it ventured past Arcturus in 2294.

Missions for the *Astronomischen Rechen-Institut* will usually be purely exploratory. This might be anything from a voyage to an interesting stellar body to the search for and exploration of, colonisable planets. First priority in these missions is the acquisition of new knowledge, although often with an eye to exploiting that knowledge for the benefit of the ARI.

## COPYRIGHT AND PATENT RIGHTS

The Foundations and Corporations are vitally concerned with the issue of copyrights and patents, as this is what their fortunes are made from. Most governments enforce limits on copyrights and patents, however, with copyrights expiring after 20 years and patents after 10. The governments' reasoning is that these times are sufficient to accrue a reasonable profit and pay for development costs, without stifling further innovation. Some nations, like Indonesia and the Inca Republic, do not recognise international copyright and patent law at all.

### **The Life Foundation**

*Headquarters:* Isle of Summer, Wellon, Tirane, Alpha Centauri, Core.

*Mission Statement:* To promote colonisation efforts.

*Products/Services:* Colony planning, infrastructure design, transportation.

*Language(s):* Esperanto, English, Spanish.

*Culture:* Open, forward-thinking, idealistic.

*Staff Levels:* 8,000 at headquarters, another 17,000 throughout human space, plus personnel at the colony on Austin's World.

*Scope of Operations:* All of human space but concentrated on the Latin Finger of the Chinese Arm.

Devoted to colonisation and increasingly to humanitarian efforts, the Life Foundation has its beginnings in the initial colonisation efforts on Alpha Centauri. Grants are provided to willing and talented individuals who wish to colonise other worlds but who might otherwise not have been able to do so due to national or economic considerations. In its beginning years, the Life Foundation was at the service of nations seeking particular individuals and skills that might have been in short supply. From that base, the Life Foundation has become its own entity, promoting colonisation throughout human space.

---

## OTHER FOUNDATIONS

*Academia Del Lincei:* Based out of Rome, the Academia is focused on the quest for antiquity, its artefacts, its ideals and its knowledge, making it an almost totally Earth-centred foundation. It has a reputation for eccentricity.

*AECA:* The American Extrasolar Colonisation Administration supports American exploration and colonisation efforts throughout the American Arm and the Beta Aquilae sector. A well-meaning, if somewhat ponderous, bureaucracy.

*Alberta Farmers' Cooperative:* Based out of Calgary, Canada, the AFC has a major role in the exploitation of newfound worlds along the Canadian branch of the Manchurian Arm, along with the provision of genetically-engineered seed stock and grain supplies to many worlds throughout Human space.

*Foundation For Practical Knowledge:* With its headquarters in the Wellon city of Swansea, on Tirane, the Foundation for Practical Knowledge focuses on pure research; anything from ground-based laboratory studies on genetics to the maintenance of a data collection facility in an asteroid belt.

*L'Institut Des Etudes Xenologiques:* The IEX, an academic institution funded by the French government, is the foremost organisation on Earth dedicated to studying the diversity of alien life forms, including intelligent life.

*Instituto Nacional De Astronomia Practica:* INAP is a joint venture by the governments of Argentina and Mexico and its activities focus mainly on the exploration of the Montana-Procyon branch of the Chinese Arm. There are rumours of INAP involvement in more clandestine operations.

*Paix Avec les Xenos:* PAX is a new organisation that insists all the problems humanity has had with the Kaefers are simply the result of a misunderstanding or even Human aggression. PAX is extremely unpopular on the French Arm and sees most of its support from the Core, mostly Earth.

*The Royal Society:* Chief catalyst in British interstellar activities, the Royal Society has the Royal Family's blessing and the parliamentary government's tolerance, along with endowments and popular support from all of Britain to promote all sorts of colonial and exploratory expeditions on the Frontier.

*The Transhuman League:* Just as the terrorist group ProVolution supports the cause of directed human evolution through violence and revolution, the Transhuman League advances it through political action and protest. The chief aim of the League is to restart research in DNA modifications and to make the technology legally available everywhere.

There are numerous smaller, less well-known organisations performing similar functions to the listed Foundations and organisations.

---

The Life Foundation's greatest achievement has been its colonisation effort on DM-3 1123 (Austin's World) on the route from Montana (Omicron2 Eridani) to Procyon (far along the Chinese Arm) – an effort accomplished using solely the Foundation's assets.

Their current major project is the construction of two deep-space stations to create a bridge between Earth and the further reaches of the Chinese Arm. Built in cooperation with the governments of Texas and Brazil, these stations are being built with first generation stutterwarp tuning systems, allowing tug operations between Earth and the further reaches of the Chinese Arm. The stations, located between Earth and the outpost at Qingyuan (UV Ceti B) are expected to come online within the next five years and could cut months off transit time from Earth to the Latin Finger, not to mention many other worlds deep in the Chinese Arm. This route is the most advantageous for all colonies along the Chinese Arm and so furthers the Foundation's goal most effectively. However, many outposts and the Manchurian colony at Cold Mountain stand to lose considerable trade if the shortcut proves viable.

Missions for the Life Foundation will focus on new colonisation efforts. This does not always mean new worlds, however. Often, it is as difficult a job to begin a colony on a new continent as on a new planet.

## NORTH AMERICAN RESEARCH LEAGUE

*Headquarters:* Vancouver, Canada, Earth, Sol, Core.

*Mission Statement:* To prevent the ravaging of any ecosystem and to promote peaceful interactions between nations, cultures and species.

*Products/Services:* Environmental assessment, alternative technologies.

*Language(s):* English, French, many others.

*Culture:* Open but somewhat paranoid at the same time, very sceptical of government and, in particular, of large corporations.

*Staff Levels:* 10,000+ throughout human space, along with millions of supporters, mostly in the Core.

*Scope of Operations:* Throughout human space.

The name 'North American' was derived from the chief source of charitable support for the organisation at its conception. Today the League enjoys interstellar support of its activities to keep planetary ecologies safe from overexploitation and the mediation of national disputes. Despite employing unorthodox tactics at times, the League and its far-flung membership can be found pursuing peaceful solutions to critical situations in all corners of human space. Most of their support, however, comes from the Core Worlds and it is there that the Foundation's policies are decided. Their most notable operation until recently was their successful mobilisation of world opinion to free the Xiang slaves from the Sung.

Missions for NARL are usually begun by whatever local personnel discover the problem, augmented by hired troubleshooters. For this reason, the organisation keeps a file of expert agents for

hire, all of whom can be trusted to travel to the location and solve the problem in a manner approved by NARL headquarters. These agents often face personal danger but they reap the rewards of travel to exotic places, as well as having large expense accounts.

## **ZAPAMOGA**

*Headquarters:* Gdansk, Poland, Earth, Sol, Core.

*Mission Statement:* To provide opportunities for those who lack them to resettle on new worlds in an atmosphere of hope and prosperity.

*Products/Services:* Food certification, health services, Colony planning and support, emergency services and aid.

*Language(s):* Chinese English, French, Polish, Russian.

*Culture:* Dedicated, driven orderly.

*Staff Levels:* 110,000 throughout Human space.

*Scope of Operations:* Throughout Human space.

*Zapamoga* was formed in the chaos that followed the Twilight War, providing succour to refugees in and around Poland. *Zapamoga's* mission gradually changed as the organisation transported Europeans to settlements in Africa, Asia and South America and later carried people from Earth to colonies on distant worlds.

Missions for *Zapamoga* will usually involve the transportation of people or goods to a colony site or as part of a larger effort to provide support and aid in the event of a disaster.

## **TRANSNATIONAL CORPORATIONS**

The Transnational Corporations or Transnats, exist in a peculiar grey zone. They are nominally based out of one country but the scope of their operations covers many worlds. In these situations, there is a delicate balance between loyalty to nation and loyalty to corporation. As the Transnats expand and offer greater services and rewards to their employees, this loyalty shifts away from the nation. Some of the Transnats are powerful enough to have colonies and Trilon has even laid claim to an entire world.

## **REBCO SAR**

*Headquarters:* Lansdowne, Wellon, Tirane, Alpha Centauri, Core

*Mission Statement:* To provide the best and most appropriate human resource to tackle any problem, anywhere.

*Products/Services:* Employment services, troubleshooting, security and mercenaries.

*Language(s):* English, French, Urdu.

*Culture:* Free-wheeling but at the same time very cautious. All operations must be above-board.

*Staff Levels:* 125,000 throughout Human space, including contractors.

*Scope of Operations:* Human space, Kaefer homeworld.

In the year 2244, two financial institutions on Earth, the Rawal Pindi Trading Company of Pakistan and the National Express Bank of America, merged to become Rebcos.

The majority of Rebcos's business involved financial services on Earth but in 2257, after developing a large internal security force, the corporation created a splinter group dedicated to providing short-term security forces to organisations on colony worlds. This began with uniformed guards for corporations and over time ranged up to include mercenary troops for small colonial governments and even rescue operations. Rebcos relocated their new organisation's offices to the colony of Wellon, on Tirane and they called it 'Rebcos Search and Rescue,' or, more succinctly, 'Rebcos SAR'. Since then, Rebcos SAR has expanded from providing security forces to matching persons seeking employment with employers looking for experienced personnel.

Missions for Rebcos SAR can involve anything. If there is money to be made, Rebcos SAR will most likely be willing to get involved, although its coordinators pride themselves upon their honest reputation and will avoid overtly criminal activities.

## **TRILON**

*Headquarters:* Portland Oregon, United States, Earth, Core.

*Mission Statement:* Providing the best quality products and services, at a reasonable price, with an appropriate rate of return.

*Products/Services:* Consumer products, computers, starships.

*Language:* English.

*Culture:* Guarded, somewhat conservative, security-conscious.

*Staff Levels:* 720,000, mostly on Earth and Kie Yuma.

*Scope of Operations:* Core, American Arm, French Arm.

Founded in 2167 in the wake of the settlement of Alpha Centauri, Trilon has grown from a starship maintenance company to the largest private starship construction firm in Human space.

Trilon is now one of the largest corporations in Human space, with extensive Earthside and colonial holdings. In addition to its starship business, Trilon also has a large consumer product division and Trilon products can be found in virtually every home.

In the mid 2200's they began settling the French Arm world of Kie-Yuma, using their resources to terraform the planet into habitability. Forty years along, the project is expected to produce a breathable atmosphere within 20 years.

## **AmeriCo**

*Headquarters:* New York, America, Earth, Sol, Core.

*Mission Statement:* 'Our mission is to be the premier consumer products company in Human Space, focused on convenience foods, beverages and personal grooming products. We seek to produce healthy financial rewards to investors as we provide opportunities for growth and enrichment to our employees, our business partners and the communities in which we operate.'

*Products/Services:* Carbonated beverages, snack foods, personal grooming products, smuggling.

*Language(s):* English, French, Mandarin.

*Culture:* Profit is paramount.

*Staff Levels:* 650,000.

*Scope of Operations:* Core, American Arm.

---

## OTHER LARGE CORPORATIONS AND TRANSNATIONALS

*Aberdeen Mineral Exploitation Company (AMEC):* Mining, investments.

*Aerotech SA:* Aerospace Manufacturing.

*Aquitaine Corporation:* Sensor Drones.

*Arno:* Small Arms.

*Bridgeport-Swift:* Vehicles.

*British Exospace:* Space drones, missiles and small starships.

*Darlan Optophysique:* Energy weapons and fusion systems.

*DunArmCo:* Armament Systems.

*General Service Transport:* Large-scale transport.

*Gorman Systems Ltd:* Heavy industrial products.

*Hundeman Industries:* Sensor Drones.

*Hyde Dynamics:* Spacecraft, missiles, drones.

*Kaskaskia Arms:* Military small arms.

*Leyland-Armstrong:* Reaction-drive spacecraft.

*Microtechnica Computers:* Hardware and software.

*Mineria Resurcas de Argentina (MRA):* Mining and mineral processing.

*Momotaro Technologies:* Japanese consumer electronics firm with military ties.

*Niyazawa International Bank:* One of the largest investment banks in Human space.

*Sortech Enterprises:* Robotics and Drones.

*Sumatro-Fabrique:* Heavy Industry, including weapons systems.

*Tiranefabrik:* Heavy industry, especially large vehicles and hovercraft.

*Vannoccio:* Luxury vehicles.

---

AmeriCo began in America in the late 22nd Century as a door-to-door operation selling health and beauty products. Over the years, AmeriCo spread into other markets, such as beverage bottling, light manufacturing and other consumer goods. Eventually the corporation was established as an American tradition. As the colonisation of the stars began, AmeriCo began to target the colonial market and soon it became a multi-world organisation.

As AmeriCo's original members died, they left their corporate holdings to their descendants. One of these saw the opportunity to use AmeriCo's numerous, far-flung factories as fronts for smuggling operations. Today, it is estimated that nearly 30 percent of all AmeriCo manufacturing locations serve periodically as ports of entry for illegal goods.

This problem is the most severe on the American Arm, where AmeriCo has the majority of its holdings.

## FAR VENTURES BIO-TOOLS

*Headquarters:* Ouroboros Facility, French Continent, Beta Canum, French Arm.

*Mission Statement:* Sell Humans Our Best/Wonderful Tools.

*Products/Services:* Pentapod bio-tools and products.

*Language:* English, French, Pentapod Dialect C9

*Culture:* Decidedly strange.

*Staff Levels:* 2,000 humans and 8,000 Pentapods, all at Beta Canum.

*Scope of Operations:* French Arm.

This joint Human-Pentapod corporation was set up in the late 2280s to market Pentapod biotechnology products to humans. Although Pentapod products are not allowed on Earth, Tirane

---

## CRIMINALS AND SMUGGLERS

Many criminal organisations have made the leap to the stars. The Italian Mafia still maintains its reputation as the premier criminal organisation but it faces heavy competition from the Russian Organizatsiya, the Japanese Yakuza, the Franco-Corsican Union Corse, the Cantonese Triads, the Freihafen Blackhands and many others. All of these groups have their hands in various pots, including the traditional vice operations and high-risk loans. They have also branched out into biologicals smuggling, slavery, illegal implants and starship theft.

---

is more flexible and serves as the primary market for Pentapod goods. They are likewise popular across the French Arm but due to the quarantine by Earth, are seldom seen in either the American or Chinese Arms.

## TERRORIST GROUPS

Terrorist groups often start out dedicated to a cause they feel is just but end up descending into an endless circle of violence as the original cause becomes lost in rhetoric and cycles of revenge.

## PROVOLUTION

*Headquarters:* Dispersed.

*Mission Statement:* The reigning social order must be removed in order for humanity to realise its true destiny. Natural evolution is done, humanity must finish the job.

*Products/Services:* Cybernetics, prosthetics, nihilistic terrorism.

*Language(s):* English, French, Mandarin, Russian.

*Culture:* Violent, secretive, will go to any lengths to accomplish a goal. Not overly subtle, however.

*Staff Levels:* Unknown, likely 500 or so core members, plus many affiliates.

*Scope of Operations:* Core Worlds and terrorist actions along the Chinese and French Arms.

Early in the 21st Century, a small group of Russian and Chinese scientists decided that the communist revolution had lost its purity of vision. Rejecting the individualism of Western society, they believed that nothing mattered but the advancement of the human race. They saw in the sciences of cybernetics and genetic engineering the potential to increase the abilities of humans immeasurably. In order to achieve their goals, they plotted to seize political power. They never got the chance. Their plans were uncovered and the principals arrested. When news reached the West, a British journalist labelled it 'The Pro-Evolutionist Plot'. In public parlance, the group became known as 'Provolution'.

Late in the 23rd Century, Provolution took credit for a terrorist bombing on Tirane. At first it was dismissed as a hoax but attacks along the Chinese Arm soon made it obvious that Provolution was in existence once again. The group stated its goal as 'the destruction of Earth's power over the colony worlds to prepare for the next step in evolution, which is human-directed evolution'.

Provolution genetically and mechanically enhances its agents but, because of limited resources and unconcern for the individual, worries little about side effects. Provolution agents are often powerful but they pay for it in terms of shortened life expectancy, constant pain and/or mental instability. Also, it is believed that a few of society's missing persons end up as experiments on Provolution lab tables each year.

*Notes:* ProVolution members have the 'Fanatic' disadvantage

### **CHILDREN OF MAO**

*Headquarters:* Tibetan Plateau.

*Mission Statement:* China must be reunited and return to the teachings of Mao Zedong.

*Products/Services:* Targeted terrorism, assassinations, drug smuggling.

*Language(s):* Cantonese, Mandarin.

*Culture:* Secretive and subtle. Does a great deal of work behind the scenes.

*Staff Levels:* Thought to be in the range of 5,000-8,000, with many sympathisers.

*Scope of Operations:* Core Worlds and terrorist actions along the Chinese Arm.

The Children of Mao preach an aesthetic of Communism and talk a great deal about 'levelling society' and 'equality for all'. However, their main goal at the present time is to reunite the three present Chinese nations into the historical nation of China. Once that is accomplished, then the commissars of the New People's Revolution can bring everyone together through the teachings of the Red Book.

Until then it is Nonex explosives and AS-89 gauss rifles.

*Notes:* Children of Mao members have the 'Fanatic' disadvantage.

### **EARTH FIRST**

*Headquarters:* Vanuatu Islands and nearby waters.

*Mission Statement:* Earth must come first, the colonies are a pointless distraction.

*Products/Services:* Anti-colonial terrorism, piracy and info-hacking.

*Language(s):* Chinese, English, French.

*Culture:* Loud, bragging, bigoted.

*Staff Levels:* Thought to be in the range of 2,000-3,000, although Earth First claims 'millions' of supporters.

*Scope of Operations:* Core Worlds, with terrorist actions within eight light years of Earth.

Earth First believes that the colonies, including Tirane, are a waste of resources. They point to the fact that Earth is hardly pristine and still bears the scars of Twilight. They claim that the money spent on extra-solar colonisation could have made Earth into a paradise. Generally oppose space flight of any kind.

*Notes:* Members of Earth First have the 'Bigoted' disadvantage towards colonials of all types.



# CHARACTER GENERATION

Character Generation follows the rules in the *Traveller Core Rulebook* but with some important differences as outlined here.

Careers in 2300AD are taken from the *Traveller Core Rulebook* and all careers are available. For humans, the Barbarian class is only available to certain human cultures, both on Earth and on a few colony worlds.

## HUMAN CULTURAL TRADITIONALISTS

Certain Human cultures are advocates of combining traditional lifestyles with modern life. Through preserving their traditional practices, they maintain their culture. The closest exemplar of this in *Traveller* Character Generation is the Barbarian Specialty, although these people are far from that stereotype. These people are also thoroughly part of the modern world and can freely move into more 'modern' careers. Foremost among these are the native groups of America, Australia, Brazil and Canada. In game terms, characters from these cultures can choose Drifter (Barbarian) as their first career.

## CHARACTER GENERATION CHECKLIST

Basic Character Generation uses the following steps:

1. Roll Characteristics and determine Characteristic modifiers as per the *Traveller Core Rulebook*.
2. Determine background:
  - a. Choose a Nationality.
  - b. Choose a Homeworld noting where it is located (Core or Frontier).
  - c. Choose a Body Type limited by Homeworld gravity. Record any Advantages or Disadvantages obtained.
  - d. Gain background skills based upon Frontier or Core.
  - e. Choose education skills per *Traveller Core Rulebook* but only 1 + Education DM.
  - f. Generate character's Background Options .
  - g. Generate or choose the character's Focus.
  - h. Apply Homeworld gravity modifiers and DNA modifications with associated Traits.
3. Enter a career:
  - a. Choose a career. You cannot choose a career you have already left.
  - b. Roll to qualify for that career.
  - c. If you qualify for that career, go to Step 4.

- d. If you do not qualify for that career, then you can go to the Draft or enter the Drifter career. The Draft can put you back into a career you have been forced to leave, at your old rank. You can only apply for the Draft once.
4. If this is your 1st career, receive 0 in all service skills. If not, receive 0 in one service skill.
  5. Choose a specialisation for this career.
  6. Career skills and survival:
    - a. Choose one of the Skills and Training tables for this career and roll on it.
    - b. Roll for survival on this career.
    - c. If you succeed, go to Step 7.
    - d. If you did not succeed, then events have forced you from this career. Roll on the Mishap table, then go to Step 9.
  7. Events:
    - a. Roll for Events.
    - b. Optionally, establish a Connection with another Player Character.
  8. Advancement:
    - a. Roll for Advancement.
    - b. If you succeed, choose one of the skills and training tables for this career and roll on it. Increase your Rank and take any bonus skills from the Ranks table for this career.
    - c. If you roll less than the number of terms spent in this career, you must leave this career.
    - d. Military characters (Army, Navy, Marines) can roll for commission instead of rolling for advancement.
  9. Increase your age by four years. If your character is 34 or older, roll for Ageing. **This is modified by the Longevity Trait, from Background Options.**
  10. If you are leaving the career, roll for Benefits using 2300AD Mustering Out tables, not those in the *Traveller Core Rulebook*.
  11. If you have left your current career, then go to Step 3 to choose a new career or to Step 12 if you wish to finish your character. Otherwise, go to Step 5.
  12. Finalise any Connections with other characters.
  13. Choose a Campaign Skill Pack and allocate skills from that pack.
  14. Purchase starting equipment and, if you can afford it, a spaceship.

## CHARACTERISTIC SCORES

Characteristic scores are generated as per the *Traveller Core Rulebook*, with humans having a range of 2–12, modified by Homeworld Gravity. Titles of nobility arising from SOC are not generally used but the general SOC level is still a valid indicator

of one's place in society. Characters from societies that still possess a peerage may elect to use the appropriate title, with the approval of the Referee. These stats are generated as normal.

## CHARACTER BACKGROUND

### NATIONALITY

The first step in character background is to choose their nationality. This will limit the range of colony worlds possible and, with the exception of the four independent colonial nations, all nationalities are represented in the Core. Nationality also determines the character's native language.

### HOMEWORLD

Characters can choose from the two worlds in the *Core* or the 29 worlds on the *Frontier*. Frontier world colonists have DNA modifications or 'DNAMs' available, which are largely banned in the Core. In contrast, Core worlders have slightly more background options available.

Within the selections of Frontier or Core a player can select normal gravity, low gravity or micro-gravity. The high gravity homeworld type is only available on the Frontier.

All colony worlds are listed near the beginning of the Frontier chapter, along with the main colony's gravity and trade data. Players should select a homeworld and use the listed gravity or else select a gravity value and work with the Referee to select a world.

### BODY TYPE

Body type reflects the basic physical build of the character and grants additional advantages and disadvantages.

*Normal* body type is just that, normal, without any benefits or penalties.

The *Mesomorph* is the classic body-builder-type, heavy and powerfully built but perhaps not as flexible as some others.

The *Ectomorph* is the dancer or gymnast body type, built slighter and more slender than normal, with greater flexibility.

The *Endomorph* is epitomised by the short, heavy-set build, usually strong and tough, with greater emphasis on the tough. They make good pilots, due to their shorter stature and acceleration tolerance.

Base height is based on Homeworld type and then modified by Body type. Base Mass for all characters is 85 kg. Character height and mass can be within 10% of these averages.

| Homeworld Gravity | Average Height (cm) |
|-------------------|---------------------|
| Micro-gravity     | 205                 |
| Low gravity       | 195                 |
| Normal gravity    | 185                 |
| High gravity      | 165                 |

The advantages and disadvantages are further explained in their section of the chapter.

A character must meet the physical requirements and limitations of a body type in order to take that body type.

Female characters are, on average, 10 centimetres shorter and 10 kilograms lighter than their male counterparts.

The gravity of a character's homeworld is a limiting factor on body types, as shown in the following table:

| Gravity Type | Body Types Available            |
|--------------|---------------------------------|
| Micro-Gee    | Ectomorph and Normal            |
| Low-Gee      | Ectomorph, Mesomorph and Normal |
| Normal       | All                             |
| Heavy-Gee    | Endomorph, Mesomorph and Normal |

### Homeworld Skills and Education Skills

Homeworld Skills and Background Options are selected according to whether the character is from the Frontier or the Core.

Characters from the Frontier automatically get Mechanic at level 0 and Computer at level 0. Characters from the Core get Science (History) at level 0 and Informatics (new skill) at level 0. Both also get one choice from the appropriate column on the following table, at level 0:

| Core            | Frontier                 |
|-----------------|--------------------------|
| Admin           | Animals                  |
| Art             | Drive (Wheeled or Hover) |
| Drive (Wheeled) | Gun Combat (Slug Rifle)  |
| Flyer (Any)     | Navigation               |
| Language        | Survival                 |
| Streetwise      | Trade (Any)              |

| Body Types | Requirements | Advantages | Disadvantages | Height Mod (cm) |
|------------|--------------|------------|---------------|-----------------|
| Mesomorph  | Str 9+       | Powerful/2 | Heavy/2       | +10             |
| Ectomorph  | Dex 8+       | Fast/2     | Skinny/1      | +15             |
| Endomorph  | End 8+       | Robust/2   | Heavy/1       | -15             |
| Normal     | N/A          | —          | —             | —               |

## EDUCATION SKILLS

Characters also get Education skills, as per the *Traveller Core Rulebook*. However, they only receive 1 + Education DM, rather than 3.

## BACKGROUND OPTION PACKAGES

All characters have four Focus Packages they can choose from. There are also specific background option tables they can roll on. Some are limited by what position the Nation (or owning nations, for colonies) is on the national Tier structures, which rates how wealthy and advanced a nation is. Option packages provide a mix of Traits and equipment for the character to have when starting play. Note that this is separate from the benefits in the Mustering Out tables for their respective careers.

Background items are Traits and items that are available courtesy of the character's background, which are differentiated based on whether the Character is from the Core or the Frontier.

## CORE BACKGROUND OPTIONS

The Core is a more cosmopolitan place than the Frontier, with greater options for most people. Therefore, in the Core, you roll once in each column of the following table.

Roll once for each Core Option column plus once in the Disadvantages column. Only roll on the Disadvantages II column if called for by a Disadvantages roll.

Tier 1 and 2 nations add 1 to the roll. Tier 4 nations subtract 1 from the roll.

Most of the background options can be found in the Traits section.

*Art (hobby)*: This gives the character one of the Art skills at level 0.

### Core Background Table

| Roll 1d6 | Core Option 1     | Core Option 2     | Disadvantages                   | Disadvantages II |
|----------|-------------------|-------------------|---------------------------------|------------------|
| 0        | Art (Hobby)       | Disease Resistant | Roll on Disadvantages II column | Poor             |
| 1        | Ally              | Internal Clock    | Rival                           | Bigoted          |
| 2        | Property          | Art (Hobby)       | Manic                           | Annoying Trait   |
| 3        | Vehicle           | Ally              | Depressed                       | Dependent        |
| 4        | Contact           | Contact           | Rival                           | Enemy            |
| 5        | Neural Jack       | Luck              | Arrogant                        | Ugly             |
| 6        | Augmented Reality | Longevity/1       | Addiction                       | Dark Secret      |
| 7        | Subdermacomp      | Longevity/2       | Roll on Disadvantages II column | Crack            |

### Frontier Background Table

| Roll 1d6 | Planetary Option | Spacer Option | Disadvantages                   | Disadvantages II  |
|----------|------------------|---------------|---------------------------------|-------------------|
| 0        | Animal (Pet)     | Contact       | Roll on Disadvantages II column | Poor              |
| 1        | Ally             | Ally          | Rival                           | Chronic Pain      |
| 2        | Property         | Vacc Suit     | Manic                           | Persistent Injury |
| 3        | Vehicle          | Internal Map  | Rival                           | Dependent         |
| 4        | Contact          | Skin Suit     | Sensory Impaired                | Dependent         |
| 5        | Property         | Nightvision   | Rival                           | Dark Secret/1     |
| 6        | Weapon           | Fast          | Enemy                           | Annoying Traits   |
| 7        | Neural Jack      | Neural Jack   | Roll on Disadvantages II column | Tormented         |

*Augmented Reality*: Character has a layer of implants and cameras, allowing him to see the world as he wishes. The Core has infrastructure that caters to this but on the Frontier it can only work with an interface to a portable or sub-dermal computer.

*Neural jack*: Character has a Neural jack implanted, allowing direct mind-machine interfaces to be made.

*Vehicle*: Character has a personal vehicle, usually a ground car, monowheel or motorcycle for Core characters.

## FRONTIER BACKGROUND OPTIONS

All frontier characters have a fundamental set of options programmed into their genetic structure through DNA modification. This allows them to successfully adapt to their new world. Each planet description describes the DNA modification that a character can choose. In general, a character will get one of the DNA modifications available for their homeworld, along with any listed Traits, which would be in addition to the listed DNA modifications.

Characters from orbital facilities, asteroids and other low gravity situations have a different set of options available, whether they are from the Core or the Frontier.

Characters from outposts typically do not undergo DNA modification, aside perhaps the basic Colonist Standard variety. Often one of the goals of a planetary outpost will be to develop an appropriate DNA modification to fit the conditions of that world. Frontier characters roll once under either the Planetary Option or Spacer Option, as appropriate and once under the Disadvantages column. Only roll on the Disadvantages II column if called for by a Disadvantages roll.

Colonies of Tier 1 and 2 nations add one to the roll, while characters from Tier 4 colonies subtract 1 from the roll.

Most of the options can be found in the Traits section, the rest are explained here.

*Animal (Pet):* This is something like a Neo-Dog, which confers an advantage. A selection of neo-engineered pets can be found in the Animals section of this book.

*Skin Suit:* This is an advanced TL12 skin suit, made from memory plastics and advanced synthetics. It includes a life support system.

*Vacc Suit:* This is a standard TL 11 pressure suit, with PLSS.

*Vehicle:* On the frontier, this will be an ATV or a hoverjeep.

*Weapon:* This will be a civilian weapon, unless the character is a member of a colonial militia.

### SELECT OR GENERATE FOCUS

Focus refers to a character's basic motivation. They are named according to the suites from a deck of cards. For PCs, these provide a focus for role-playing. For NPCs, these represent primary character motivations and will be further detailed for use with NPCs in the NPC chapter.

A player can either choose the Focus for their Character or use a deck of cards to randomly draw a Focus. This deck can also be used when creating NPCs, to determine their focus and motivation.

The four areas of Focus are

- Clubs – Violence
- Hearts – Social Interaction
- Diamonds – Wealth
- Spades – Curiosity

Note that these differ somewhat from the classic 2300AD uses for these terms.

Players must choose their Focus then roll once for each column in the Focus category. If a duplicate of a Trait is rolled, then the Character receives the Trait at a higher level. Rolling Luck twice would give the character Luck 2.

### CLUBS (VIOLENCE)

Clubs are not necessarily violent, however, they have no real fear of violence and can be quite skilled in its application. The Options available for Clubs reflects this.

### HEARTS (SOCIAL)

Characters with the Heart Focus concentrate on social interactions. This can be anything from the party animal, to the seducer, to the politician. They know how to get under someone's skin and manipulate them to achieve their goals.

### DIAMONDS (WEALTH)

To a Diamonds character, the accumulation of wealth or property is the end-goal in life. Everything else they do has that goal in mind, somewhere. This does not mean that they are not good people, far from it. They are just always looking for an angle.

### SPADES (CURIOSITY)

Spades are keenly interested in finding the truth. This can lead them down the road of science, along a path of faith or somewhere in-between. This archetype can often be found in agents, investigators and scientists, along with priests and theologians.

### APPLY HOMEWORLD GRAVITY MODIFIERS

Mankind has settlements from the floors of oceans to the depths of space, with a multitude of worlds settled, from micro-gravity asteroid mines to the crushing gravity of King. The different

### CLUBS

| Roll 1d6 | Option 1            | Option 2     | Flaws             |
|----------|---------------------|--------------|-------------------|
| 1        | Coolness Under Fire | Nightvision  | Arrogant          |
| 2        | Ally                | Fearless     | Enemy             |
| 3        | Fast                | Hard to Kill | Dependent         |
| 4        | Weapon              | Luck         | Persistent Injury |
| 5        | Tough               | Weapon       | Vengeful          |
| 6        | Rapid Recovery      | Acute Senses | Annoying Traits   |

### HEARTS

| Roll 1d6 | Option 1   | Option 2 | Flaws     |
|----------|------------|----------|-----------|
| 1        | Persuasion | Empath   | Arrogant  |
| 2        | Contact    | Luck     | Dependent |
| 3        | Contact    | Sexy     | Coward    |
| 4        | Ally       | Ally     | Rival     |
| 5        | Ally       | Wealthy  | Enemy     |
| 6        | Empath     | Vehicle  | Rival     |

## DIAMONDS

| Roll 1d6 | Option 1     | Option 2       | Flaws           |
|----------|--------------|----------------|-----------------|
| 1        | Wealthy      | Wealthy        | Arrogant        |
| 2        | Contact      | Property       | Enemy           |
| 3        | Ally         | Wealthy        | Rival           |
| 4        | Contact      | Luck           | Annoying Traits |
| 5        | Ally         | Property       | Dependent       |
| 6        | Common Sense | Eidetic Memory | Bigoted         |

## SPADES

| Roll 1d6 | Option 1       | Option 2       | Flaws           |
|----------|----------------|----------------|-----------------|
| 1        | Internal Map   | Vehicle        | Manic           |
| 2        | Eidetic Memory | Sixth Sense    | Annoying Traits |
| 3        | Contact        | Neural Jack    | Coward          |
| 4        | Ally           | Luck           | Rival           |
| 5        | Ally           | Internal Clock | Phobia          |
| 6        | Tough          | Common Sense   | Poor            |

gravity environments are reflected in the use of Gravity Type. High gravity is any world with a surface gravity of 1.26 G or higher. Normal gravity is the range from 0.76 to 1.25 G, while Low gravity is 0.75 G down to 0.11 G. Micro-gravity is classified as anything less than 0.10 G. So an outpost on Earth's moon is classified as Micro-gravity, while a base on Mars is classified as Low gravity.

On the character's homeworld, all stats are used as rolled. However, once they are off the homeworld they should apply the modifiers to Strength and Dexterity from the table that follows, along with the listed Traits.

Gravity Effects can increase a character's Characteristics above 12, although not reduce them below 0. Any stat brought to 0 means that the character in question is unable to move effectively in that environment.

## GRAVITY EFFECTS

| Dex/Str    | Destination |       |          |         |
|------------|-------------|-------|----------|---------|
|            | Micro-G     | Low-G | Normal-G | Heavy-G |
| Homeworld  |             |       |          |         |
| Micro-Gee  | 0/0         | +1/-2 | +2/-4    | +3/-6   |
| Trait      | Nil         | Nil   | Slow     | Slow    |
| Low-Gee    | -1/+1       | 0/0   | +1/-2    | +2/-4   |
| Trait      | Nil         | Nil   | Nil      | Slow    |
| Normal-Gee | -2/+2       | -1/+1 | 0/0      | +1/-2   |
| Trait      | Fast        | Nil   | Nil      | Nil     |
| Heavy-Gee  | -3/+3       | -2/+2 | -1/+1    | 0/0     |
| Trait      | Fast        | Fast  | Nil      | Nil     |

## CAREERS

All of the careers from the *Traveller Core Rulebook* are applicable in the *2300AD* setting. This section will provide notes on using each one within this setting.

### A NOTE REGARDING CURRENCY

Despite the past reversals suffered by the French nation, the French Empire is still one of the most, if not the most, powerful economy in human space. This economic clout has made the French Livre the most common of international trade.

When converting values, 1 Livre (Lv1) in *2300AD* = Cr1 from *Traveller*.

## THE FOUNDATIONS

There are a number of Foundations, usually dedicated to scientific pursuits or colonial or environmental advocacy. They are detailed in a separate chapter but the main ones are listed on the following table:

| Foundation                                | Nationality           | Area of Interest                         |
|---|-----------------------|--|
| The Astronomisches Institut der Bayern    | German                | Space Exploration                        |
| <i>Accademie del Lincei</i>               | Italian               | Antiquities, Religion                    |
| North American Research League (NARL)     | Canadian/<br>American | Environmental Advocacy and Protection    |
| Transhuman League                         | International         | Directed Human Evolution                 |
| <i>Institute des Études Exobiologique</i> | French                | Alien Biology                            |
| <i>Life Foundation</i>                    | International         | Colonisation and humanitarian operations |

## LEVEL 0 SKILLS

All skills gained through careers are Level 1 skills. Level 0 skills only come from Background skills or Basic Training.

## Mustering Out Benefits

Civilian characters can only get civilian weapons as a mustering out benefit; they cannot get military weapons unless they are past or present members of a colonial militia.

## AGENT

Law enforcement agents, spies, troubleshooters and others who work in the shadows. This career is in demand with many nations, colonies and corporations. While conflict is often part of the Agent's life, they are not all gunslingers

### MUSTERING OUT BENEFITS (ALL AGENTS)

| Roll | Cash     | Other Benefits            |
|------|----------|---------------------------|
| 1    | Lv500    | Scientific Equipment      |
| 2    | Lv1,000  | +1 Int                    |
| 3    | Lv2,000  | Ship Share                |
| 4    | Lv4,000  | Weapon                    |
| 5    | Lv5,000  | Neural Jack               |
| 6    | Lv15,000 | +1 Social or Subdermacomp |
| 7    | Lv25,000 | 2 Ship Shares             |

## NOTABLE COLONIAL POLICE AGENCIES

Several police agencies are widely regarded as being the stand-out examples of law enforcement on the Frontier. Among these are the Tanstaaf Rural Police, who suffered severe casualties at the hands of Kaefers in several attacks, the Texas Rangers, a paramilitary police force holding sway on Texas' three holdings and the Royal Canadian Mounted Police, who maintained order on the Canadian colony of Kanata even when the government collapsed under corporate pressure.

## ARMY

Members of the planetary armed fighting forces. Soldiers deal with planetary surface actions, battles and campaigns. Such individuals may also be mercenaries for hire.

2300AD covers a variety of national militaries. The following tables give the equivalent ranks for several major nations.

## LA LÉGION ÉTRANGÈRE

The French Foreign Legion is the most famous military organisation in human space. Their training is excellent, although not up to par with Special Forces or other elite units. Their esprit de corps, however, is unmatched. Legionnaires do not leave their comrades behind and will continue to fight long after other units would have abandoned the battlefield. After one term of service Legionnaires are eligible for French citizenship.

The enlistment DM for the Foreign Legion is +1, however, there is also a -1 Survival DM, for all terms. Any nationality may join the Legion but the vast majority of their officers are seconded from regular Army service. All non-French legionnaires automatically get French 0 as part of their basic training.

### MUSTERING OUT BENEFITS (ARMY)

| Roll | Cash     | Other Benefits             |
|------|----------|----------------------------|
| 1    | Lv1,000  | Neural Sheathing           |
| 2    | Lv2,500  | +1 Int                     |
| 3    | Lv5,000  | +1 Edu                     |
| 4    | Lv5,000  | Weapon                     |
| 5    | Lv5,000  | Armour                     |
| 6    | Lv10,000 | Neural Sheathing or +1 End |
| 7    | Lv15,000 | +1 Soc                     |

## NCO RANKS

| Rank | France        | Germany            | Britain                 | United States                  | Manchuria       | Ukraine           |
|------|---------------|--------------------|-------------------------|--------------------------------|-----------------|-------------------|
| 0    | Fantassin     | Soldat             | Private                 | Private                        | Lie Bing        | Ryadovoy          |
| 1    | Caporal       | Oberge frieter     | Lance Corporal          | Private, 1 <sup>st</sup> Class | Shang Den Bing  | Ryadovoy          |
| 2    | Caporal-chef  | Unteroffizier      | Corporal                | Corporal                       | Yi Ji Shi Guan  | Gefreiter         |
| 3    | Sergent       | Feldwebel          | Sergeant                | Sergeant                       | Er Ji She Guan  | Mladshiy Serzhant |
| 4    | Sergent-chef  | Oberfeldwebel      | Colour Sergeant         | Staff Sergeant                 | San Ji She Guan | Serzhant          |
| 5    | Adjutant      | Hauptfeldwebel     | Warrant Officer Class 2 | Master Sergeant                | Wu Ji She Guan  | Starshiy-Serzhant |
| 6    | Adjutant-chef | Oberstabsfeldwebel | Warrant Officer Class 1 | Sergeant Major                 | Liu Ji She Guan | Starsnina         |

## OFFICER RANKS

| Rank | France      | Germany          | Britain     | United States | Manchuria   | Ukraine            |
|------|-------------|------------------|-------------|---------------|-------------|--------------------|
| 0    |             |                  |             |               |             |                    |
| 1    | Lieutenant  | Leutnant         | Lieutenant  | Lieutenant    | Shao Wie    | Mladshiy Leytenant |
| 2    | Capitaine   | Hauptmann        | Captain     | Captain       | Shang Wie   | Kapitan            |
| 3    | Commandant  | Major            | Major       | Major         | Shao Xiao   | Mayor              |
| 4    | Lt. Colonel | Obersleutenant   | Lt. Colonel | Lt.Colonel    | Zhong Xiao  | Podpolkovnik       |
| 5    | Colonel     | Oberst           | Colonel     | Colonel       | Shang Xiao  | Polkovnik          |
| 6    | General     | Generalleutenant | General     | General       | Shang Jiang | General-Polkovnik  |

## MERCENARY ORGANISATIONS

The universe of *2300AD* is a turbulent place and there are many mercenary organisations selling their services. They range in size from the 22 man 'Snake-Eaters', a special forces outfit, up to the 2,000 strong Tanstaaf Free Legion, formed in 2298 to protect that colony from the alien Kaefers,

| Name                    | Specialty                           | Size   |
|-------------------------|-------------------------------------|--|
| Darkseid                | Space defence and interdiction      | 5 ships, 422 personnel                         |
| McDonough's Highlanders | Ground forces training cadres       | 100 troops                                     |
| Panzergruppen Trafft    | Hover tanks and conventional armour | 6 hover tanks, 3 tracked tanks, other vehicles |
| 4th Albion Sappers      | Civil and combat engineering        | 87 troops and specialists                      |

## CITIZEN

There are two types of Citizens: Core and Frontier. These two sections replace the Citizen's Career from the *Traveller Core Rulebook*.

### CORE CITIZEN

**Qualification:** Int 6+, -1 DM for every previous career.

**Assignments:** Choose one of the following:

- Corporate: From clerk to corporate exec.
- Worker: Cog in the machine, this represents technical workers.
- Freelancer: Some people do not fit into Core corporate culture or are simply unable to find permanent work in a culture of endemic high unemployment

**Basic Training:** Unlike other careers, a Core Citizen gains initial level 0 skills from the appropriate Specialist table instead of the Service Skills table in basic training.

## MISHAPS

| 1d6 | Mishaps   |
|-----|---|
| 1   | Injured. Roll on the Injury table.  |
| 2   | You are harassed and your life ruined by a criminal gang. Gain the gang as an Enemy.  |
| 3   | Hard times caused by a lack of interstellar trade costs you your job. Lose one Social Standing.   |
| 4   | Your business is investigated by national or international authorities. Co-operate and the business is shut down but you gain a +2 DM to the Qualification check for your next career as a reward for your assistance. Refuse and gain an Ally. |
| 5   | A political upheaval or uprising throws your life into chaos, forcing you to leave the country. Roll Streetwise 8+. If you succeed, increase any skill you have by one level.   |
| 6   | One of your co-workers develops a hatred of you and sabotages your life. Gain a Rival.  |

## SKILLS AND TRAINING:

|   | Personal Development | Service Skills | Advanced Education (Minimum Edu 10) |
|---|----------------------|----------------|-------------------------------------|
| 1 | +1 Edu               | Drive          | Art (any)                           |
| 2 | +1 Int               | Flyer          | Advocate                            |
| 3 | Carouse              | Streetwise     | Diplomat                            |
| 4 | Gambler              | Melee          | Language                            |
| 5 | Drive (wheeled)      | Steward        | Computers                           |
| 6 | Jack of All Trades   | Trade          | Medic                               |
|   | Corporate            | Worker         | Freelancer                          |
| 1 | Advocate             | Drive (any)    | Admin                               |
| 2 | Admin                | Mechanic       | Drive (any)                         |
| 3 | Broker               | Trade (any)    | Deception                           |
| 4 | Computers            | Engineer       | Streetwise                          |
| 5 | Diplomat             | Trade (any)    | Trade (any)                         |
| 6 | Leadership           | Science        | Computers                           |

## RANKS AND BENEFITS

| Rank | Corporate      | Skill or Benefit | Worker            | Skill or Benefit | Freelancer | Skill or Benefit |
|------|----------------|------------------|-------------------|------------------|------------|------------------|
| 0    | Clerk          |                  | Apprentice        |                  | Newbie     |                  |
| 1    |                |                  |                   |                  |            |                  |
| 2    | Analyst        | Admin 1          | Technician        | Trade 1          | Hacker     | Computer         |
| 3    | Manager        |                  |                   |                  |            |                  |
| 4    | Senior Manager | Advocate         | Craftsman         | Mechanic         | Stringer   | Streetwise       |
| 5    |                |                  |                   |                  |            |                  |
| 6    | Director       | +1 Social        | Master Technician | Engineering      | Contractor | Engineering      |



## EVENTS

| 2d6 | Events  |
|-----|---|
| 2   | Disaster! Roll on the Mishap table but you are not ejected from this career.  |
| 3   | A memetic campaign goes awry, plunging the country's capital into chaos. Gain either Advocate 1, Explosives 1, Persuade 1 or Streetwise 1. Roll whichever skill you chose 8+. If you succeed you come out on the winning side and gain a +2 DM to your next Advancement roll. Fail and you suffer a -2 DM to your next Survival roll.               |
| 4   | You spend time maintaining and using remote-operated vehicles, either as part of your job or as a hobby. Increase Mechanic, Remote Operations or Recon  |
| 5   | Your business expands or your corporation grows. Gain a +1 DM to any one Benefit roll.  |
| 6   | You are given advanced training in a specialist field. Roll Education 10+ to gain any one skill of your choice at level 1.  |
| 7   | Life Event. Roll on the Life Events table ( <i>Traveller Core Rulebook</i> page 34).  |
| 8   | You learn something you should not have – a corporate secret, a political scandal – which you can profit from illegally. If you choose to do so, then you gain a +1 DM to a Benefit roll from this career and gain Deception 1, Streetwise 1 or a criminal Contact. If you refuse, you gain nothing. In any case, you have the Dark Secret/1 Trait. |
| 9   | You are rewarded for your diligence or cunning. Gain a +2 DM to your next Advancement check.  |
| 10  | You gain experience in a technical field as a computer operator or surveyor. Increase Comms, Computers or Engineer.   |
| 11  | You befriend a superior in the corporation or with a client. Gain an Ally. Either gain Diplomat 1 or take a +4 DM to your next Advancement roll thanks to his aid.  |
| 12  | You rise to a position of power in your corporation. You are automatically promoted   |

## CAREER PROGRESS

| Career     | Survival | Advancement |
|------------|----------|-------------|
| Corporate  | Soc 6+   | Int 6+      |
| Worker     | End 5+   | Edu 8+      |
| Freelancer | Int 7+   | Edu 8+      |

## MUSTERING OUT BENEFITS (CORE CITIZENS)

| Roll | Cash     | Other Benefits  |
|------|----------|-----------------|
| 1    | Lv500    | Ship Share      |
| 2    | Lv2,500  | Ally            |
| 3    | Lv5,000  | +1 Int          |
| 4    | Lv5,000  | Gun             |
| 5    | Lv5,000  | +1 Edu          |
| 6    | Lv25,000 | Two ship shares |
| 7    | Lv50,000 | Neural Jack     |

## FRONTIER CITIZENS

Qualification: Int 6+

-1 DM for every previous career.

*Assignments:* Choose one of the following:

- **Corporate:** These people represent corporate interests on a colony.
- **Worker:** This represents technical workers and occupations like mining on the frontier.
- **Homesteader:** This is the classic ideal of the colonist, the farmer/rancher who heads out into the planetary outback to create a new life.

First Term colonists who have served a term in another career have a -1 DM to Survival and Advancement rolls in their first terms only. Further, however, colonists of Cold Mountain, Beowulf and Crater suffer a further -1 DM on Survival rolls, which applies to all terms served as a Colonist.

For Cold Mountain colonists, any receipt of Gun Combat during the Colonist career has to be taken as Melee instead, typically Blade.

*Basic Training:* Unlike other careers, a Frontier Citizen gains initial level 0 skills from the appropriate Specialist table instead of the Service Skills table in basic training.

## MUSTERING OUT BENEFITS (FRONTIER CITIZENS)

| Roll | Cash     | Other Benefits   |
|------|----------|------------------|
| 1    | Lv250    | One Ship Share   |
| 2    | Lv1,300  | Personal Vehicle |
| 3    | Lv2,500  | Ally             |
| 4    | Lv2,500  | +1 Int           |
| 5    | Lv2,500  | Weapon           |
| 6    | Lv15,000 | +1 Edu           |
| 7    | Lv25,000 | Property/3       |

## CAREER PROGRESS

| Career      | Survival | Advancement |
|-------------|----------|-------------|
| Corporate   | Soc 6+   | Int 6+      |
| Worker      | End 5+   | Edu 8+      |
| Homesteader | Int 7+   | End 8+      |

## SKILLS AND TRAINING

|   | Personal Development | Service Skills | Advanced Education (Minimum Edu 10) | Corporate  | Worker      | Homesteader        |
|---|----------------------|----------------|-------------------------------------|------------|-------------|--------------------|
| 1 | +1 Edu               | Drive          | Trade (any)                         | Advocate   | Drive (any) | Animal             |
| 2 | +1 Int               | Flyer          | Medic                               | Admin      | Mechanic    | Drive (any)        |
| 3 | Carouse              | Survival       | Diplomat                            | Broker     | Trade (any) | Athletics          |
| 4 | Gambler              | Melee          | Language                            | Computers  | Engineer    | Jack of All Trades |
| 5 | Drive (wheeled)      | Steward        | Computers                           | Diplomat   | Trade (any) | Survival           |
| 6 | Jack of All Trades   | Trade          | Admin                               | Leadership | Science     | Mechanic           |

## RANKS AND BENEFITS

| Rank | Corporate  | Skill or Benefit | Worker            | Skill or Benefit | Homesteader   | Skill or Benefit |
|------|------------|------------------|-------------------|------------------|---------------|------------------|
| 0    | Clerk      |                  | Apprentice        |                  | Newcomer      |                  |
| 1    |            |                  |                   |                  |               |                  |
| 2    | Associate  | Admin            | Technician        | Trade            | Farmer        | Survival         |
| 3    |            |                  |                   |                  |               |                  |
| 4    | Supervisor | Advocate         | Craftsman         | Mechanic         | Master farmer | Mechanic         |
| 5    |            |                  |                   |                  |               |                  |
| 6    | Director   | +1 Social        | Master Technician | Engineering      | Stationmaster | Broker           |

## EVENTS

| 2d6 | Events  |
|-----|---|
| 2   | Disaster! Roll on the Mishap table but you are not ejected from this career.  |
| 3   | A corporation attempts a hostile takeover of the colony and the government dissolves. Gain either Advocate 1, Explosives 1, Persuade 1 or Streetwise 1. Roll whichever skill you chose 8+. If you succeed you come out on the winning side and gain a +2 DM to your next Advancement roll. Fail and you suffer a -2 DM to your next Survival roll.  |
| 4   | You spend time maintaining and using heavy vehicles, either as part of your job or as a hobby. Increase Drive (any), Flyer (any), Engineer (any) or Mechanic by one level.  |
| 5   | Your business expands, your corporation grows or the colony thrives. Gain a +1 DM to any one Benefit roll.  |
| 6   | You are given advanced training in a specialist field. Throw Education 10+ to gain any one skill of your choice at level 1.   |
| 7   | Life Event. Roll on the Life Events table ( <i>Traveller Core Rulebook</i> page 34).  |
| 8   | You learn something you should not have – a corporate secret, a political scandal – which you can profit from illegally. If you choose to do so, then you gain a +1 DM to a Benefit roll from this career and gain Deception 1, Streetwise 1 or a criminal Contact. If you refuse, you gain nothing. In any case, you have the Dark Secret/1 Trait. |
| 9   | You are rewarded for your diligence or cunning. Gain a +2 DM to your next Advancement check.  |
| 10  | You gain experience in a technical field as a computer operator or surveyor. Increase Comms, Computers or Engineer.   |
| 11  | You befriend a superior in the local government or a prominent corporation. Gain an Ally. Either gain Diplomat 1 or take a +4 DM to your next Advancement roll thanks to his aid.   |
| 12  | You rise to a position of power in your corporation. You are automatically promoted.  |

## MISHAPS

| 1d6 | Mishaps  |
|-----|--|
| 1   | Injured. Roll on the Injury table.   |
| 2   | You are harassed and your life ruined by a raider gang. Gain the gang as an Enemy.   |
| 3   | Hard times caused by a lack of interstellar trade costs you your farm or business. Lose one Social Standing.   |
| 4   | Your colony is investigated by national or international authorities. Co-operate and the colony is placed into government control but you gain a +2 DM to the Qualification check for your next career as a reward for your assistance. Refuse and gain an Ally. |
| 5   | A political upheaval or uprising throws your life into chaos, forcing you to leave the colony. Roll Streetwise 8+. If you succeed, increase any skill you have by one level.   |
| 6   | One of your neighbours develops a hatred of you and sabotages your life. Gain a Rival.   |

## COLONISING FOUNDATIONS

Several Foundations are actively concerned with promoting colonisation. They will often provide education and training to prospective colonists, as well as providing a source of investment and support for the colonies themselves. Some notable colonising Foundations include:

| Name                         | Nation             | Notes                             |
|------------------------------|--------------------|-----------------------------------|
| Royal Society                | Britain and Wellon | Colony Development                |
| <i>Zapamoga</i>              | Poland             | Settlement assistance and support |
| Life Foundation              | International      | Colony and technical support      |
| Alberta Farmer's Cooperative | Canada             | Crop development                  |
| INAP                         | Mexico             | Settlement assistance             |

**Colonial Militias:** Many worlds have a colonial militia that acts as a part-time defence force. A militia can only be joined in the character's second term or later as a colonist. Militia enlistment is an Average Task, with a DM of +2 for any prior military or scout service. As a militia member, Gun Combat skills can be taken in energy weapons and the receipt of a weapon as a mustering out benefit can be a military weapon. Some notable militias include the Hermes White Wing militia, the French Colonial Militia and the Tanstaaf Militia.

### DRIFTER

The Barbarian specialty is renamed to Cultural Traditionalist and is only open to the Native Nations in Canada, United States, Brazil, Papua and Australia.

The other Drifter specialties are common throughout human space.

### MUSTERING OUT BENEFITS (DRIFTER)

| Roll | Cash    | Other Benefits |
|------|---------|----------------|
| 1    | None    | Contact        |
| 2    | None    | Weapon         |
| 3    | Lv500   | Ally           |
| 4    | Lv1,000 | Weapon         |
| 5    | Lv1,500 | +1 Edu         |
| 6    | Lv2,000 | Ship Share     |
| 7    | Lv4,000 | +1 Int         |

### ENTERTAINER

Professional athletes and entertainers are very important to Core life, as both aspiration and diversion. They tend to be very well paid, at least at the professional level.

### TOP ENTERTAINMENT

Total Immersion Theatre has been available for about two years now and uses holographic projection and directed sound to place the members of the audience in the action, although usually only in passive roles, following along with the viewpoint of the hero or a companion. There are a few examples of games that take advantage of this technology as well, including the top game of 2299, 'MindRaider'.

### MUSTERING OUT BENEFITS (ENTERTAINER)

| Roll | Cash     | Other Benefits          |
|------|----------|-------------------------|
| 1    | None     | Contact                 |
| 2    | None     | +1 Social               |
| 3    | Lv5,000  | Contact                 |
| 4    | Lv5,000  | +1 Social               |
| 5    | Lv20,000 | Famous Trait            |
| 6    | Lv20,000 | Sexy Trait              |
| 7    | Lv40,000 | +1 Social, +1 Education |

### MARINES

Marines serve as ship's troops and light assault forces. They are often called upon to spearhead attacks, no matter the circumstances.

In the United States they are part of the original Marine Corps, which itself was an outgrowth of the old wet navy. In Britain they are a separate service, with the table of ranks based on the old Royal Marine Commandos. In France, they are part of the Space Forces and are more of a Special Forces group than light assault forces. All serve the same basic role, however.

### MUSTERING OUT BENEFITS (MARINES)

| Roll | Cash     | Other Benefits |
|------|----------|----------------|
| 1    | Lv1,000  | Armour         |
| 2    | Lv2,500  | +1 Int         |
| 3    | Lv2,500  | +1 Edu         |
| 4    | Lv5,000  | Neural Jack    |
| 5    | Lv10,000 | Weapon         |
| 6    | Lv15,000 | +1 End         |
| 7    | Lv20,000 | +1 Soc         |

### MERCHANT CORPORATIONS AND LIBERTINE TRADERS

There are several large merchant and shipping corporations in Human space, including the Trilon Corporation, Maersk Shipping and Mataglap Interstellar Freight and Finance. In addition, however, there are literally hundreds of Libertine traders, which are small trading ventures or family groups. Some equate them to the gypsies or tinkers of space; small, mobile, with their own code of honour. These Libertine families have names like the Singhs, the Shaugnessys and the O'Rourkes. Somewhat paranoid and suspicious of outsiders, they form a large part of the trade between colony worlds, yet they rarely visit the overly-regulated worlds of the Core.

## MERCHANTS

Throughout Human Space and beyond, there are individuals and groups moving goods back and forth, looking for deals and trying to make it rich. Or at least stay flying. The merchants are the lifeblood of the interstellar economy, with the smaller groups and even individuals filling in the gaps around the big shipping concerns.

*Languages:* All Merchants receive French 0 and English 0, if they do not already have them.

### MUSTERING OUT BENEFITS (MERCHANTS)

| Roll | Cash     | Other Benefits    |
|------|----------|-------------------|
| 1    | Lv500    | Weapon            |
| 2    | Lv2,500  | +1 Int            |
| 3    | Lv5,000  | +1 Edu            |
| 4    | Lv10,000 | +1 Soc            |
| 5    | Lv10,000 | Ship Share        |
| 6    | Lv20,000 | Two Ship Shares   |
| 7    | Lv20,000 | Three Ship Shares |

## NAVY

Whether the American Space Force, the British Royal Space Navy or the German *Stern Marine*, the Navy is the line of ships and people that serve to defend their nations and worlds from others or project force to serve their nations' ends.

Some Navies grew out of their nation's maritime tradition, like the British Royal Navy and the Deutsche Stern Marine. Others, however, grew from their nation's Air Force tradition, like the United States Space Force and Japan's Sutā Tsubasa Ryodan (or 'Star Wing Brigade').

*Languages:* All Naval characters receive English 0, if they do not already have it. Naval Officers receive English 1

### MUSTERING OUT BENEFITS (NAVY)

| Roll | Cash     | Other Benefits          |
|------|----------|-------------------------|
| 1    | Lv1,000  | One Ship Share          |
| 2    | Lv2,500  | +1 Intelligence         |
| 3    | Lv3,000  | +1 Education            |
| 4    | Lv5,000  | Weapon                  |
| 5    | Lv7,000  | Ground or Hover Vehicle |
| 6    | Lv25,000 | Two Ship Shares         |
| 7    | Lv40,000 | +2 Social Standing      |

## NCO RANKS

| Rank | Imperial French Space Force    | Germany Stern Marine | Britain Royal Space Navy  | United States Spaceforce      | Manchuria       | Ukraine Space Navy            |
|------|--------------------------------|----------------------|---------------------------|-------------------------------|-----------------|-------------------------------|
| 0    | Matelot                        | Matrose              | Ordinary Spacehand        | Spacer                        | Lie Bing        |                               |
| 1    | Matelot brevete                | Gefreiter            | Able Spacehand            | Spacer, 1 <sup>st</sup> Class | Shang Den Bing  | Matros                        |
| 2    | Quartier-maître de 2ème classe | Unteroffizier        | Leading Spacehand         | Senior Spacer                 | Yi Ji Shi Guan  | Starshiy Matros               |
| 3    | Quartier-maître de 1ère classe | Bootsmann            | Petty Officer             | Staff Sergeant                | Er Ji She Guan  | Starshyna 2-oyi statti        |
| 4    | Second-maître                  | Hauptbootmann        | Chief Petty Officer       | Technical Sergeant            | San Ji She Guan | Starshyna 1-oyi statti        |
| 5    | Maître                         | Stabsbootmann        | Warrant Officer Class Two | Master Sergeant               | Wu Ji She Guan  | Holvnyy starshyna             |
| 6    | Premier-maître                 | Oberstabsbootmann    | Warrant Officer Class One | Senior Master Sergeant        | Liu Ji She Guan | Holvnyy korabel'nyy starshyna |

## OFFICER RANKS

| Rank | France      | Germany          | Britain        | United States | Manchuria   | Ukraine            |
|------|-------------|------------------|----------------|---------------|-------------|--------------------|
| 0    |             |                  |                |               |             |                    |
| 1    | Lieutenant  | Leutnant         | Mid-shipman    | Lieutenant    | Shao Wie    | Molodshiy Leyenant |
| 2    | Capitaine   | Hauptmann        | Sub-lieutenant | Captain       | Shang Wie   | Leytenant          |
| 3    | Commandant  | Major            | Lieutenant     | Major         | Shao Xiao   | Starshiy Leyenant  |
| 4    | Lt. Colonel | Obersleutenant   | Lt. Commander  | Lt.Colonel    | Zhong Xiao  | Kapitan III Ranhu  |
| 5    | Colonel     | Oberst           | Commander      | Colonel       | Shang Xiao  | Kapitan II Ranhu   |
| 6    | General     | Generalleutenant | Admiral        | General       | Shang Jiang | Kapitan I Ranhu    |

## NATIONAL NOBILITY

Very few societies still have titles of nobility in common use. The following list covers the major users:

Britain, Canton, Inca Republic, Manchuria, Netherlands, France, Spain, Wellon and Alicia (on Beowulf). Argentina's land-holding aristocracy does not use titles.

## NOBILITY

While most nations in *2300AD* lack a hereditary nobility, there are exceptions. Even those without formal titles of nobility still have social classes, with the elite, usually rich and powerful, at the top.

### MUSTERING OUT BENEFITS (NOBILITY)

| Roll | Cash      | Other Benefits                                       |
|------|-----------|--|
| 1    | Lv5,000   | One ship share                                       |
| 2    | Lv5,000   | Two ship shares                                      |
| 3    | Lv25,000  | Dueling sword or other weapon (as chosen by referee) |
| 4    | Lv25,000  | +1 Social  |
| 5    | Lv50,000  | 4 Luxury Suite Passages                              |
| 6    | Lv50,000  | Use of family yacht (at Referee's discretion)        |
| 7    | Lv100,000 | +1 Social, use of family yacht (as above)            |

## ROGUE

Wherever there are people, there are criminals who exist to prey on them. Rogues can be honest thieves, preying only on those who can afford it, to basic back-alley thugs, breaking the legs of whomever they are told to.

On the Rogue Mishap Table, a roll of 3–4 results in the character also receiving the Wanted trait.

### MUSTERING OUT BENEFITS (ROGUE)

| Roll | Cash     | Other Benefits |
|------|----------|----------------|
| 1    | None     | Wanted         |
| 2    | None     | Weapon         |
| 3    | Lv5,000  | +1 Int         |
| 4    | Lv5,000  | Ship Share     |
| 5    | Lv25,000 | Armour         |
| 6    | Lv50,000 | +1 Dex         |
| 7    | Lv50,000 | Infamous       |

## SCHOLAR

In *2300AD*, scholars can be old-school academics, lecturing crowds of students or field researchers, sifting through ancient ruins on alien planets. Physicians can be trauma surgeons, operating in some desperate Core city hospital, treating the victims of the latest 'Crack' incident or be a doctor on a remote colony world, trying to find the cure to a plague, with help from Earth weeks or even months away.

## MUSTERING OUT BENEFITS (SCHOLAR)

| Roll | Cash     | Other Benefits              |
|------|----------|-----------------------------|
| 1    | Lv2,500  | +1 Int                      |
| 2    | Lv5,000  | +1 Edu                      |
| 3    | Lv10,000 | Subdermacomp or Neural Jack |
| 4    | Lv15,000 | +1 Soc                      |
| 5    | Lv20,000 | Scientific Equipment        |
| 6    | Lv30,000 | Ship Share                  |
| 7    | Lv50,000 | Two Ship Shares             |

## SCOUT

The scouts are employed by a variety of agencies from national governments to corporations such as Trilon and Foundations like the AIB.

In *2300AD*, Scouts do not have the paramilitary trappings of the *OTU* scouts. In addition, *2300AD* does not have the tradition found in *Traveller* that a scout never really retires. There are no detached-duty scouts in *2300AD*, nor can a scout in *2300AD* receive a small starship for his/her own personal use.

Scouts operating with a naval structure will use the appropriate naval table for ranks, while those in corporate service use the ranks/titles appropriate for that organisation.

### MUSTERING OUT BENEFITS

| Roll | Cash     | Other Benefits              |
|------|----------|-----------------------------|
| 1    | Lv10,000 | Ship Share                  |
| 2    | Lv10,000 | +1 Int                      |
| 3    | Lv15,000 | +1 Edu                      |
| 4    | Lv15,000 | Weapon                      |
| 5    | Lv25,000 | Neural Jack or Subdermacomp |
| 6    | Lv25,000 | Ship Share                  |
| 7    | Lv25,000 | Two Ship Shares             |

## TRAITS — ADVANTAGES AND DISADVANTAGES

As a result of character background, including world of origin and DNA modifications, characters can have a variety of advantages and disadvantages, which are received as part of the random Character Generation process.

If a character receives seemingly-contradictory Traits, perhaps from their Background Focus and their Homeworld Gravity, they just cancel each other out, on a level-per-level basis. So a character who receives Slow/1 from their homeworld but Fast/2 from Focus and benefits, would then have Fast/1.

If you are using the point-buy system, they can be purchased using points and all characters receive an extra two points for this purpose. This only applies to characters generated using the point-buy system. Minor Advantages cost one point, while

Minor disadvantages contribute one point. Major Advantages and Disadvantages are two points, while Critical Traits are three points.

Characters can have no more than seven points of Advantages and five points of disadvantages, when using the point-buy system.

Traits marked with an \* are usually found only in aliens and genetically-modified characters.

## Advantages

### Acute Senses (Minor)

One of the character's senses (sight, hearing, touch or smell/taste) is extra-sharp. They receive a +2 DM for checks that rely on this sense. This advantage may be purchased once for each of the character's senses.

### Ally (Minor, Major or Critical)

The character has developed a relationship with someone who will go out of their way to help. The relationship with this ally goes both ways, however – they may occasionally also ask for help. The character should be careful not to abuse this relationship, because allies will stop being so if not treated properly. Each receipt of Ally can be used for a new Ally or to increase the level of an existing Ally.

An Ally/1 has some measure of influence and/or skill, while an Ally/2 is moderately influential and/or skilled and an Ally/3 is very influential and/or skilled.

### Ambidextrous (Minor)

The character is capable of using either hand effectively and functionally has no preference. They can continue to function normally if one of their hands or arms is wounded.

### Amphibious (Minor, Major, Critical) \*

The alien or uplift is able to operate in or out of water with near-equal facility.

|              | Swimming Speed | Underwater Endurance   | Out of Water Endurance |
|--------------|----------------|------------------------|------------------------|
| Amphibious/1 | Walking        | Endurance x 5 minutes  | Endurance x 2 hours    |
| Amphibious/2 | Walking x 1.5  | Endurance x 30 minutes | Endurance x 12 hours   |
| Amphibious/3 | Walking x2     | Endurance x 60 minutes | Endurance x 3 days     |

### Aquatic (Minor, Major, Critical) \*

The alien, uplift or DNAM recipient is adapted to life underwater. It can breathe underwater or hold its breath for a long period (Endurance x 10 minutes on average). The species cannot operate out of water without mechanical aid or telepresence.

|           | Swimming Speed | Underwater Endurance   |
|-----------|----------------|------------------------|
| Aquatic/1 | Walking        | Endurance x 10 minutes |
| Aquatic/2 | Walking x 2    | Endurance x 2 hours    |
| Aquatic/3 | Walking x4     | Unlimited              |

### Armoured (Minor, Major, Critical) \*

The creature possess thick fur, scales, a bony exoskeleton or other natural protection that gives it one point of natural armour per level.

### Atmospheric Requirements (Minor, Major, Critical) \*

The species requires an unusual combination of gasses to breathe and cannot survive in most atmospheres without artificial aid. Creatures with this trait at the Critical level usually come from homeworlds with an Exotic atmosphere. Lower levels indicate non-standard pressures or mixes required.

### Common Sense (Major)

The character has a sense for when a course of action or inaction is foolish. Whenever the character is about to participate in something that is foolhardy, the Referee will make a secret Intelligence check – if successful, they will warn the character of the potential mistake.

### Contact (Minor, Major or Critical)

The character knows someone who can provide limited help or pass on important information. Unlike an Ally, this person does not ask for much in return other than the occasional favour. Each receipt of a Contact can be used for a new Contact or to increase the level of an existing Contact.

Contact/1 is either two contacts of low-ranking position or one contact of mid-level position, while Contact/2 is either two contacts of mid-level position or one contact of high-level position.

### Cool Under Fire (Major)

This trait represents a character's ability to keep their head while in combat. This grants a +2 bonus to Initiative rolls in personal combat only, along with a +1 bonus to Recon rolls to notice details while in combat. It does not apply to vehicle or spacecraft combat.

### Disease Resistant (Minor)

The character does not get ill easily and, typically, will not be unwell as long as other people. They gain a +2 DM to resist the effects of disease or illness and remain unwell only half as long.

### Double-Jointed (Minor)

With this advantage, the character's joints bend extra far. He gets a +2 DM to any skill check in which his double-jointedness might give him an advantage.

### **Echolocation (Minor, Major, Critical) \***

Like bats and dolphins, this species can use sound to navigate. Often found in creatures that hunt at night or in dim/murky or underwater conditions.

|                | Range (metres) | Detection DM |
|----------------|----------------|--------------|
| Echolocation/1 | 10             | +2           |
| Echolocation/2 | 50             | +1           |
| Echolocation/3 | 500            | 0            |

Underwater, Echolocation/3 can be used for a 2d6 stun attack with the range of a pistol.

### **Eidetic Memory (Critical)**

This is the ability to commit everything a character sees and hears to memory and to recall it at will. They have a nearly photographic recall, giving them a +4 DM to checks involving remembering things read or experienced first-hand.

### **EM Sensitivity (Major)**

The character is sensitive to a variety of EM field strengths. They can sense high-voltage lines at up to 20 metres distant and even a faint 'static' from the brains of people and animals at ranges of up to half a metre.

### **Empath (Critical)**

The character has an intuitive sense of what other people are feeling. They gain a +2 DM for interpersonal skill checks based on Intellect or Social Standing, as well as to detect lies or deception.

### **Famous (Minor, Major, Critical)**

A famous character is well-known for some heroic, inspiring or even just entertaining act or career. At a Minor level, they are known throughout their home country or colony world. At a Major level, they are well-known throughout either the Core or their home arm. At a Critical level, they are known throughout the Core and their home Arm, both.

### **Fast (Minor, Major)**

The character is faster than they look. At Fast/1, they get a +1 DM to Initiative checks and gain a +1 DM on any check of the Athletics (co-ordination) skill that applies to physical speed. At Fast/2, they get a +2 DM to Initiative checks and gain a +2 DM on any check of the Athletics (co-ordination) skill that applies to physical speed. At Fast/2 they can move up to eight metres in a Combat Round.

### **Fearless (Major)**

The character appears to others as fearless and does not get spooked easily. He is immune to the kinds of normal everyday human fears that plague people, such as those related to stress or anxiety.

### **Feral \***

Feral species are uncivilised, regardless of their technological knowledge. Often, such species have acquired their technology from other races or from Ancient ruins. Feral species are much less likely to accept the laws of more civilised societies. Feral species roll Education on 1d6 only.

### **Flyer (Minor, Major, Critical) \***

The species can fly using wings, glider membranes, gasbags or other means. Characters of this species gain the Athletics (flying) skill at Level 0 and can travel at a speed noted in their description. Flying creatures that are aloft must spend one minor action every round on movement or stall and fall out of the air.

Winged flight is tiring and can only be sustained for a number of rounds equal to the creature's Endurance before requiring a similar amount of rest. Some specialised avians can increase this to minutes or even hours equal to Endurance.

Species with glider membranes cannot gain altitude while flying. They descend one metre every time they move forwards and cannot use more than one minor action for flying movement in a round.

Species that float using gasbags or some other method do not need to move to remain aloft. They are typically slower than other fliers.

|          | Glider                                  | Flyer                                | Floater                               |
|----------|---|--------------------------------------|---------------------------------------|
| Minor    | End x 10 rounds; Dex x 15metres/round   | End x rounds; Str x 10 metres/round  | End x 10 weeks; Dex x metres/round    |
| Major    | End x 10 minutes; Dex x 10 metres/round | End x minutes; Str x 20 metres/round | End x 10 months; Dex x 2 metres/round |
| Critical | End x 10 hours; Dex x 15 metres/round   | End x hours; Str x 30 metres/round   | End x 10 years; Dex x 3 metres/round  |

### **Gifted Metabolism (Minor)**

The character's body processes foods, drugs and poisons better than other people. He gains a +2 DM to resist the effects of poisons, toxins or drugs.

### **Hard to Kill (Minor, Major or Critical)**

The character is the kind of person that fights to stay alive, even when others would pass on. At Hard to Kill/1, your character will stay alive and unconscious after reaching 0 in all his physical Characteristics but only until they have suffered an additional amount of damage equal to half his Endurance. At Hard to Kill/2, this buffer increases to equal his Endurance and at Hard to Kill/3, this buffer increases to double his Endurance.



### ***Internal Clock (Minor)***

The character has an intuitive sense of the passage of time, even when unconscious. They always know what time it is, usually within about 10 minutes. However, this internal clock is set to their time, not necessarily the clock time of the planet or colony they are visiting.

### ***Internal Map (Minor)***

The character has an intuitive sense of direction and bearing. Once they establish where they are, they remember places they have been to and how to get between them. They never get lost in cities or colonies they have been to before. This also gives a +4 DM to Navigation checks.

### ***Large (Major, Critical) \****

The species is considerably larger than the average for sophonts. Large creatures generally have a Strength and Endurance of 3d6 or even 4d6 and a Dexterity of 1d6. Life support requirements for Large creatures are doubled and they often have trouble operating in buildings and spacecraft designed for smaller creatures.

Some Large creatures are described as Huge. Attacks against Huge creatures receive a +1 DM to hit.

### ***Longevity (Critical)***

Each level of Longevity increases the average lifespan by 20 years and moves up the ageing saves by 12 years. So for humans, Longevity/1 means an average life expectancy of 108 years and ageing saves do not start until age 46 or the seventh term. Longevity/3, however, means an average life span of 148 years.

### ***Luck (Minor, Major, Critical)***

Fortune smiles on your character. At Luck/1, you can re-roll one check per session and take the higher result. At Luck/2, you can re-roll two checks per session and take the higher results. At Luck/3, you can re-roll two checks per session and take the higher result – but you can roll three times for one of those checks, taking the highest result of the three.

### ***Natural Weapon \****

The species has a natural weapon, such as claws, a strong bite or a poisonous stinger. Such weapons are usable at Personal range and deal 1d6 damage. The creature gains Melee (natural weapons) at level 0.

### ***Nightvision (Major)***

The character can see better in dim lighting than other people and halves any environmental penalties due to darkness.

### ***No Fine Manipulators \****

The species has no fingers nor other prehensile appendages, preventing them from easily picking things up, pushing small buttons, reaching into tight spaces and so on. The species will need special equipment to function in most civilised settings.

### ***Notable (Characteristic) \****

Some species are notably dextrous, intelligent, tough or strong. Characters from such races have a positive Dice Modifier when rolling for that Characteristic (+2 unless otherwise specified) and their racial maximum for that Characteristic is increased by the same amount. Any Characteristic can be Notable.

### ***Peripheral Vision (Major)***

The character can see things in more detail throughout his field of vision and is capable of making checks to notice things on the periphery of his vision that other people would miss.

### ***Powerful (Minor, Major)***

The character is either more heavily built or can take greater advantage of the muscle mass they have. Each level of Powerful grants a +1 DM to Athletics Checks involving Strength.

### ***Property (Minor, Major, Critical)***

The character owns property, perhaps land, a condo on Earth or some other sort of real estate. Property/1 gives ownership over a small house or apartment on the Core or a small farm on the frontier. Property/2 would be a large house or apartment on the core or a small ranch/station on the frontier. Alternatively, this could be some sort of vacation property on either the Core or Frontier. Property/3 confers a luxury house or apartment or a large farm/station on the frontier.

Property requires (Level x Lv4,000) per year to maintain the property and pay taxes on it.

### ***Rapid Recovery (Major)***

The character heals twice as fast as normal, regardless of mode of treatment. This only applies to physical wounds.

### ***Robust (Minor, Major)***

Each level of Robust grants a +1 DM to Endurance checks for things like disease and gravity changes.

### ***Sexy (Major)***

The character is especially attractive to the opposite sex (or those who would be attracted to their gender). They gain a +2 DM to all interpersonal skill checks involving Intelligence or Social Standing with anyone who might be attracted to them, opposite or same sex.

### ***Small \****

Small species generally have a Strength and Endurance of only 1d6 and a Dexterity of 3d6. The minimum size for a sophont is about half that of a human, as smaller creatures lack the cranial capacity for sophont-level intelligence. This assumes that the species has a brain structure comparable to humans. Species with a more distributed neural structure, such as hive intelligences or artificial intelligences can be even smaller.

Some Small creatures are described as Tiny. Attacks against Tiny creatures receive a –1 DM to hit.

### **Sixth Sense (Critical)**

The character has an intuitive sense for danger.

Whenever dangerous situations arise, the Referee will make a secret Recon or Intelligence check. If the character is successful, the Referee will inform the player that their character senses danger – although not the source or direction of it.

### **Tough (Minor, Major, Critical)**

The character can take more punishment than others. Each level of Tough adds the same amount of points to the amount of damage a character can take, to each of their physical Characteristics. For example, a character with Tough/2 is treated as being able to take an extra two points of damage each to Strength, Dexterity and Endurance (six extra damage total).

### **Wealthy (Minor, Major, Critical)**

The character has amassed a fortune. Perhaps they understand finances and investment better than others, perhaps they have a wealthy family or perhaps they just got lucky. At Wealthy/1, starting wealth is increased to 200%. At Wealthy/2, starting wealth is increased to 300%. At Wealthy/3, starting wealth is increased to 500%.

### **Disadvantages**

#### **Addiction (Minor, Major, Critical)**

The character is addicted to something, whether that be drugs, thrills, sex or whatever else. The level of the addiction indicates its seriousness.

#### **Annoying Traits (Major)**

There is something about the character that other people find extremely annoying. They suffer a –2 DM to all interpersonal skill checks involving Intelligence or Social Standing.

#### **Arrogant (Minor)**

The character thinks that they are wonderful but others do not necessarily agree. They suffer a –1 DM to all interpersonal skill checks involving Intelligence or Social Standing.

#### **Bigoted (Minor)**

The character does not like people (or cultures) that are not like them. They do not care much for people from other countries, colonies or planets or for those with other skin colours or native languages. They suffer a –2 DM to all interpersonal skill checks involving Intelligence or Social Standing when dealing with people who are not closely related to their native racial stock.

#### **Chronic Pain (Major)**

The character has an old injury or condition that still interferes with their comfort or mobility. It may be migraines, joint pain, inflammatory digestive issues or anything of that nature. At the beginning of each session, make an Endurance check; failure means they suffer a –1 DM to all checks for the first half of the day, as well as 75% movement. Some conditions may call for a re-check, at the Referee's discretion.

### **Coward (Critical)**

The character is easily frightened and they do not deal well with danger. In any dangerous situation, they must make a Difficult Intelligence check or else cower or run away.

### **'Crack' (Critical)**

The character is on the verge of a psychotic break. Other people can often sense the edginess and the character suffers a –2 on all personal interactions using Intelligence or Social Standing. In any stressful situation, there is a one in six (1 on d6) chance that the character will freak out in some fashion. Only available to characters from the Core.

### **Dark Secret (Minor, Major, Critical)**

The character has done or knows about, something that others would freak out about. At Dark Secret/ 1, this is something that makes them the target of ridicule or causes them to be lightly ostracised. Dark Secret/2 means they would gain a powerful enemy and Dark Secret/3 means incarceration or death would follow. At all levels, the characters' chances of promotion or advancement would be adversely affected.

### **Dependent (Critical)**

The character has a child, elderly parent, imprinted neo or some other effectively helpless dependent that requires resources and attention. For a star-faring character, this dependent has to travel with them in order for this to be a true disadvantage. They tend to make very good hostages.

### **Enemy (Minor, Major, Critical)**

The character has angered someone and they are out for revenge. This person will go out of their way to cause problems for the character and at least wishes to ruin, if not outright physically harm, them. An Enemy/1 has some measure of influence and/or skill, while an Enemy/2 is moderately influential and/or skilled and an Enemy/3 is very influential and/or skilled.

### **Fanatic (Minor, Major, Critical)**

There is something in life the character holds too dear, most likely an ideal. At Fanatic/1, they are willing to risk social consequences for this fanaticism, at Fanatic/2, they are willing to risk danger and at Fanatic/3, they are willing to sacrifice their life for it.

### **Heavy (Minor, Major)**

The character is heavy-set. At Heavy/1, they suffer a –1 DM to Initiative Checks, as well as a –1 DM to any Athletics checks involving Coordination or Endurance. At Heavy/2, they suffer double the penalties (–2 DM Initiative, –2 DM Athletics involving Coordination or Endurance). Also at Heavy/2 they can only move four metres during a Combat Round. Add 10 kilograms to the character's weight per level of Heavy.

### **Infamous (Minor, Major, Critical)**

An infamous character is well-known for some egregious act. At a Minor level, they are known throughout their home country or colony world. At a Major level, they are well-known throughout

either the Core or their home arm. At a Critical level, they are known throughout both the Core and their home Arm.

### **Manic (Minor)**

The character is upbeat and energetic most of the time, in an exaggerated way that is unnerving to those around them. They cannot sit still, talk too fast and have an over-inflated sense of self-esteem. In addition to all the ways this will get them into trouble, they suffer a -1 DM to all interpersonal skill checks involving Intelligence or Social Standing.

### **Persistent Injury (Minor, Major, Critical)**

Something happened to the character that impairs normal physical function. Perhaps there is something complicated that has prevented physicians from operating or replacing organs or limbs or maybe they lost a body part and something happened to prevent regenerative therapy. At Persistent Injury/1, this means they suffer a -1 DM to any checks that would be influenced by the injury (such as to Recon when missing an eye). At Persistent Injury/2, this increases to a -2 DM and to a -3 DM at Persistent Injury/3.

### **Phobia (Minor)**

There is something that scares the life out of the character. Most of the time, phobias are of simple and natural things, some of the most common being acrophobia (fear of heights), arachnophobia (fear of spiders), entymophobia (fear of insects) or scotophobia (fear of the dark). Whenever a character is confronted with the object of his fear, they suffers a -1 DM to all checks until a couple of minutes after the object is no longer an issue.

### **Poor (Minor, Major, Critical)**

The character is not financially solvent. Something has happened to ruin their financial standing, whether it is a criminal act, personal flaw or addiction. At Poor/1, their starting wealth is reduced to 75% of normal. At Poor/2, their starting wealth is reduced to 50% of normal. At Poor/3, their starting wealth is reduced to 25% of normal.

### **Rival (Minor, Major, Critical)**

The character has someone who feels they are in competition with them for something, be it an object or objective, romance or accomplishment in a particular field. The Rival will harass the character and generally attempt to out-do or humiliate them. A Rival/1 has some measure of influence and/or skill, while a Rival/2 is moderately influential and/or skilled and a Rival/3 is very influential and/or skilled.

### **Sensory Impaired (Minor)**

One of the character's senses (sight, hearing, touch, smell/taste) does not work the way it should. They receive a -2 DM for checks that rely on this sense. This disadvantage may be acquired once for each of the character's senses.

### **Sickly (Major)**

The character always seems to be unwell. They suffer a -1 DM to Initiative Checks, as well as a -2 DM to any checks involving strength or agility, especially uses of the Athletics skill.

### **Skinny (Minor, Major)**

The character is overly thin. At Skinny/1 they suffer a -1 DM to any Athletics checks involving Strength or Endurance. At Skinny/2 the penalty increases to -2DM. Subtract 10 kilograms from the character's weight per level of Skinny.

### **Slow (Minor, Major)**

For some reason, the character moves much slower than most would expect. For each level of Slow, they suffer a -1 DM to Initiative Checks and a -1 DM on any check of the Athletics (co-ordination) skill that applies to physical speed. At Slow/2, they also are reduced to a speed of four metres in a Combat Round.

### **Social Adaption Syndrome (Minor)**

The character feels twitchy and isolated most of the time. They sleeps a lot, have little motivation, are constantly pessimistic and have nothing good to say about who they are or their life in general. In addition to all the ways this can cause him problems, they suffer a -1 DM to all interpersonal skill checks involving Intelligence or Social Standing.

### **Tormented (Minor)**

The character is the kind of person who wrestles with inner demons. They may suffer from tragic self-doubt or have psychological scars from some sort of abuse. In any event, what is normal for them may not be normal for other, well-adjusted people. Although being Tormented does not have an immediate effect on social interactions, it is difficult for such people to maintain long-lasting romantic relationships. Those who have known Tormented characters for any length of time will regard them as strange or damaged as well.

### **Ugly (Major)**

The character is not an attractive person. They suffer a -2 DM to all interpersonal skill checks involving Intelligence or Social Standing that in some way involve physical appearance, although not for any skill checks to intimidate or frighten.

### **Uplifted (Critical) \***

This species was originally non-sentient but has been raised to a higher intelligence by another species. Uplifted races generally become client species of their patron.

### **Vengeful (Minor)**

The character does not take losing or being wronged very well. They do not even have to have actually lost or been wronged, they only have to perceive that they have. They suffer a -1 DM to all interpersonal skill checks involving Intelligence or Social Standing when dealing with the person upon which they wish vengeance.

Furthermore, they must make an Endurance check not to take action against the person, whether through verbal abuse, attempted humiliation, pranks, legal action or even physical violence – each time they are confronted with them.

### **Wanted (Minor, Major, Critical)**

The character has done something and is now wanted by the law or another large organisation. At Wanted/1, they have committed a minor offense and the search is not intense – although there will be a warrant for their arrest on file or a similar call to the criminal underworld. At Wanted/2, they have committed a non-violent felony, which has brought on a warrant and mild alert for their arrest. However, at Wanted/3, they have committed a violent felony and authorities everywhere are on the lookout for them. In any event, they will need a false identity to move around, unless smuggled.

### **Weak (Characteristic)**

The opposite of Notable (Characteristic), some species are weaker, less resilient or less well educated than others. Characters from such races have a negative Dice Modifier when rolling for that Characteristic (–2 unless otherwise specified) and their racial maximum for that Characteristic is decreased by the same amount. Any Characteristic can be Weak.

## NEW SKILLS AND SKILL MODIFICATIONS

The technological and cultural assumptions of 2300AD and *Traveller* have some differences and affect the Skills and Feats available to characters. Some other Skills are changed to reflect the 2300AD universe. These changes are detailed in the following pages.

### **SKILLS**

The following skills are changed in 2300AD:

#### **ASTROGATION**

Rather than being used to plot accurate jumps, this skill is used to plot stutterwarp routes, this skill remains unchanged.

#### **BATTLEDRESS**

This skill is used for the humanoid combat walkers.

#### **DRIVE**

Add the specialty Drive (Hovercraft) and Drive (Walker.)

*Drive (Hovercraft)*: This is the skill of operating hovercraft, which behave quite differently than conventional vehicles on most surfaces. This skill also governs the use of jump-jets to negotiate short obstacles but does not include the ability to fly in jump jet mode for any distance. That would require the Flyer (Vectored Thrust) skill.

*Drive (Walker)*: Although computer-controlled, walking vehicles require a different set of skills than any other land vehicle. This covers the use of two and four legged walkers. It does not include the ability to use any remote manipulator arms the walker may have or any other equipment. This is different from battledress, which is used to control powered suits, where the operator's arms and legs are slaved to the limbs of the armour.

#### **ENGINEER (JUMP DIVE)**

This skill specialty is removed and replaced with Engineer (Stutterwarp).

*Engineer (Stutterwarp)*: This skill allows the operating and fine-tuning of a ship's stutterwarp drive. *Pushing a stutterwarp drive past its discharge limit*: 1–6 hours, Very Difficult, range increased by Effect x10%. Exceptional failure means the ship is destroyed, Average failure means the stutterwarp drive is destroyed and marginal failure means the drive is damaged and must be tuned before operating again.

#### **FLYER**

Add the following specialties and remove Flyer (Grav). 2300AD does not have gravitic technologies or anti-grav vehicles.

*Flyer (Airship)*: This is the skill of piloting balloons and airships, of any sort. With an unpowered balloon, it should be combined with Navigation to plot courses with the wind.

*Flyer (Tilt-rotor)*: Flying a tilt-rotor requires a combined set of skills not common to other aircraft. Someone with Flyer (Rotor) could fly a tilt-rotor in conventional flight with a –2 DM and someone with only conventional aircraft training would have a –2 DM to operate the tilt-rotor in VTOL flight.

*Flyer (Vectored Thrust)*: Aerodynes are flying bricks without their power plants. While most other aircraft have lifting surfaces, the aerodyne is kept aloft solely by the power of its engines. Aerodynes tend to be very manoeuvrable and flying them can be tricky.

#### **GUN COMBAT (ENERGY WEAPONS)**

This skill can only be taken by military characters or colonists who are members of colonial militias.

#### **LANGUAGES**

A character can only choose Human languages unless they have spent two or more terms in the Scout career.

#### **New Skills**

##### **INFORMATICS**

This is the skill used to search databases and run network-based search inquiries. Informatics can be taken in place of the Computer skill, in all careers.

## **New Skill Packages for 2300AD**

### **TROUBLESHOOTER SKILL PACKAGE**

This package is for a group of experienced professionals who solve problems for a corporation, government agency or other organisation.

Informatics 1, Gun Combat (any) 1, Investigate 1, Medic 1, Melee (any) 1, Recon 1, Stealth 1, Streetwise 1.

### **COLONIST SKILL PACKAGE**

This package is for a campaign of players surviving the harsh challenges of a frontier world.

Animals (any) 1, Drive (any) 1, Gun Combat (any) 1, Mechanic 1, Medic 1, Navigation 1, Recon 1, Survival 1.

### **URBANITE SKILL PACKAGE**

This package is for players working the streets of a technologically advanced but decadent urban environment.

Carouse 1, Computers 1, Deception 1, Gun Combat (any) 1, Informatics 1, Melee (any), Stealth 1, Streetwise 1.

### **CORPORATE SKILL PACKAGE**

This package is for a group that largely works in a corporate environment, whether in the Core or on the Frontier.

Admin 1, Advocate 1, Deception 1, Investigate 1, Science (any) 1, Streetwise 1, Trade (any) 1.

### **LIBERTINE TRADER SKILLS PACKAGE**

This package suits a group of free traders, plying the spaceways between colonies, avoiding the Core.

Advocate 1, Broker 1, Deception 1, Diplomat 1, Engineering 1, Gun Combat (any) 1, Persuade 1, Pilot 1, Streetwise 1.

# CHARACTER GENERATION

## EXAMPLE

*Jason Andersson:* Characteristics are rolled or purchased as in the *Traveller Core Rulebook*. Andersson rolls: Str 8 (DM +0), Dex 9 (DM +1), End 7 (DM +0), Int 7 (DM +0), Edu 6 (DM +0) and Soc 6 (DM +0). Andersson chooses to be an Australian from the Frontier world of Kingsland which has Normal Gravity. Andersson picks an Ectomorph body type. This grants Andersson the Traits of Fast/2 and Skinny/1. Combining his base height of 185 centimetres (Normal gravity) with Ectomorph (+15 cm) andersson is around 200 centimetres tall. Andersson notes the following gravity effects when not in the Normal gravity of his homeworld: Within Micro-Gee Andersson has Dex 7 and Strength 10 along with the Fast advantage (for a total of Fast/3). Within Low-Gee Andersson has Dex 8 and Strength 9. Within High-Gee Andersson has Dex 10 and Str 6.

Being from the Frontier andersson automatically receives Computers 0 and Mechanic 0 as background skills. He also chooses Gun Combat 0 from the Frontier skill list. Andersson receives one Education background skill (base 1 +0 DM from Edu). He chooses Navigation 0 and Comms 0.

Andersson grew up on the surface of Kingsland, not some orbital habitat. So andersson rolls on the Planetary column of the Frontier Background Options table. Australia is a Tier 2 Nation and so he receives a DM+1 on his roll. Andersson rolls a 2 for a total of 3 and gets a Vehicle. He chooses a hoverjeep. Under the Disadvantages column Andersson rolls a 4 for a total of 5 – Rival, which the player determines to be a childhood rival who continues to be an irritant into his adult life.

Andersson's Referee allows him to choose his Focus (it could be determined randomly) and he chooses Spades – Curiosity. He rolls on the Spades table once under all three columns with results of 1, 3 and 5. Andersson gains advantages of an Internal Map and Neural Jack but a disadvantage of a Phobia.

Finally andersson checks the description of his homeworld of Kingsland for any special traits or DNAMs. Andersson receives the Colonist Standard Package DNAM along with the Cold World modification.

At this point andersson moves into his first term. See the *Traveller Core Rulebook* example for term by term explanations as they are no different than those in 2300AD. Note that during Mustering Out, 2300AD has alternate Mustering Out tables, as detailed in this earlier chapter.

# ALIEN RACES

By 2300, humanity has encountered five other sentient races, from the hostile and murderous Kaefers to the bizarre and unfathomable Pentapods. Of these races, two had starfaring capability at time of contact: the Pentapods and the mysterious Kaefers, while the Ebers lost the technology, along with all their other technology, when they bombed themselves back to the Stone Age 4,000 years ago.

## CHRONOLOGY OF CONTACT

- 2247 First Contact with the Sung.
- 2249 Discovery of Eber Ruins on Daikoku.
- 2250 First Contact with the Xiang.
- 2251 First Contact with the Pentapods.
- 2256 First Contact with the Eber.
- 2263 Pentapod enclave established on Beta Canum.
- 2255 Slaver War.
- 2295 First Contact with the Kaefers.
- 2298 Kafer Attack on Aurore.

## THE EBERS

Almost 4,000 years ago, the ancestors of the Ebers ventured out to the stars. Unfortunately, they brought their fierce territoriality and ancient hatreds with them. Interstellar war ravaged their culture, leaving only a lone colony world to survive. They have only just built themselves back to the point where they have reinvented the steam engine.

The first Eber ruins were discovered in 2249 on Daikoku and again on Heidelbergmat three years later. These discoveries set the stage for the discovery of the Ebers and their homeworld at 82 Eridani in 2256, the third alien race contacted by Humanity.

Although they are the remnants of an interstellar society, the Ebers on 82 Eridani have a level of technology roughly equal to Renaissance Europe. They still tell stories of the time when their ancestors sailed between the stars.

Initial relations with the Ebers were awkward, due to the importance of ceremony and protocol to the aliens. Once Humans understood this fact, relations became much warmer as Humans learned to adapt (and not the reverse). Humans who deal with Ebers must do so in Eber dress, using Eber customs, at an Eber's pace.

## HOMEWORLD

The ancient Eber civilisation had spread through four worlds but they are currently only found on Kormoran, the third planet of the star 82 Eridani.

## PLANET DATA

- Name: Kormoran
- Distance from Primary: 0.94 AU
- Year Length: 313.9 standard days, 423.2 local days
- Size: 14,000 km in diameter



Day Length: 17.8 hours  
 World Type: Garden  
 Surface Gravity: 1.46 G  
 Atmospheric Pressure: 1.49 atm  
 Climate: Temperate  
 Water Presence: 70%  
 Atmospheric Composition: N<sub>2</sub> (79%), O<sub>2</sub> (18%), Trace (3%)

Kormoran is a dry, hot world, with extensive deserts and deep blue seas. The surface gravity of 1.46 Gs is uncomfortable for the uninitiated but adaptation is relatively easy. Most of the civilised Ebers make their homes in the ancient ruins along the sea coasts, while the nomads have taken to the extensive desert wastes.

The two human enclaves on Kormoran are detailed in the Chinese Arm section.

### THE EBERS

Ebers are about two metres tall, heavy, bipedal creatures with thick, short legs, extremely long, thin arms and no discernible heads. The body and legs are covered with a thick, shaggy fur, usually of a rustbrown colour. The short legs and thick, heavy body give Ebers a pronounced, waddling walk. On top of the shoulders, where a head would be on a human, the Ebers have a pair of flexible eye-stalks, two long, horse-like ears and a short, trunk-like proboscis.

### TYPICAL EBER NPCS

Most Ebers encountered are from the towns and cities built on the ruins of their old civilisation, although the wilderness areas of their home world are prowled by more primitive nomads.

*Traits:* Eber are Large, Slow/1, Hard-to-Kill/1, have Peripheral Vision, Acute Senses (smell/taste), Acute Senses (Hearing) and have Annoying Traits (Personality changes).

*New Stat:* LOB (Lobe) is a measure of the degree to which Ebers seem to switch personalities.

### Typical Eber Townsperson

*Name:* Dances-in-Moonlight

STR 14 DEX 9 END 14 INT 8 EDU 6 LOB 10

*Age > 88 Career(s):* Merchant (6 terms)

*Skills:* Admin 3, Art (Flute) 2, Broker 2, Carouse 1, Melee 2, Steward 2.

*Equipment:* Spear, knife, counting beads, Human-purchased music player

*Character:* Dances-in-Moonlight has made a great deal of money acting as a broker between his people and the Arabs in the Old-town enclave. He is not overly curious about the humans but he has his eye on a nomad girl who keeps coming to town.

*Motivation:* Diamonds 8, Hearts 5. Dance-with-Moonlight loves money and how much he is making but his burgeoning romance with the nomad girl is almost as important to him.

## Kormoran

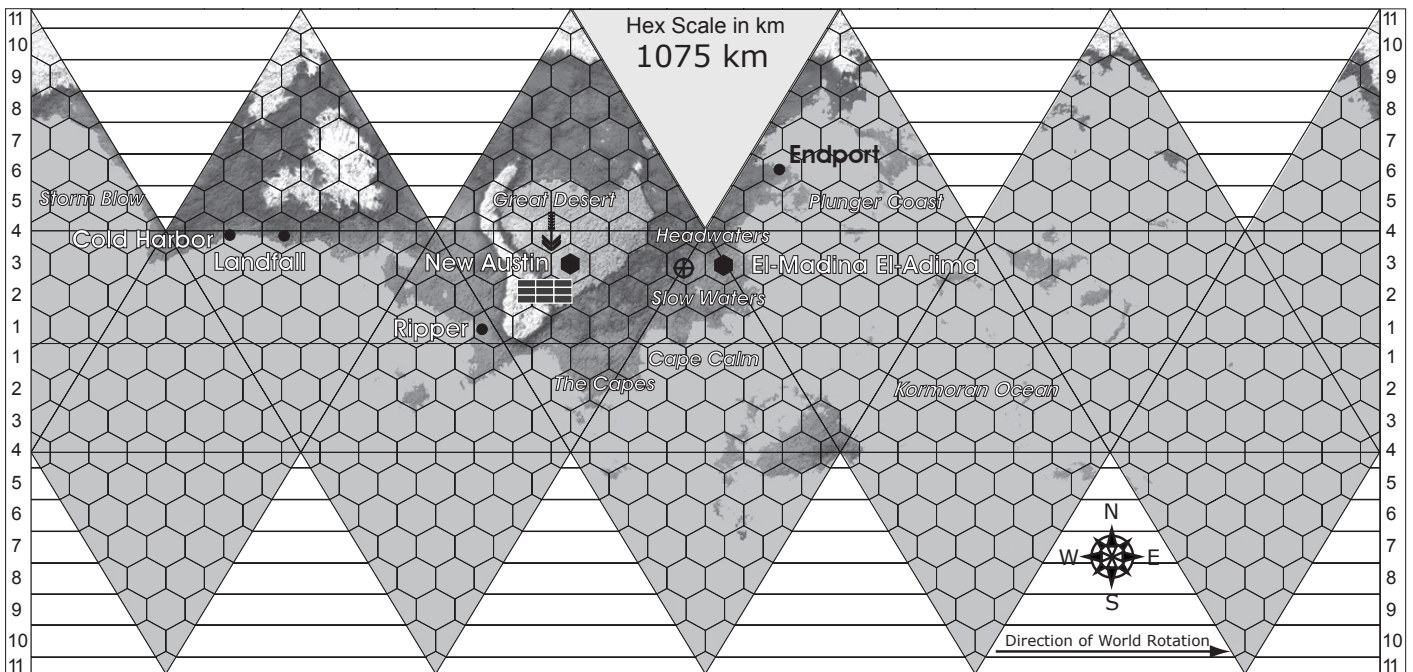

# DOLPHINS [UPLIFTED]

Although Neo-fins still help out in aquaculture projects all over Earth and explored space, the fully-sentient U-dolphin is rarely seen. A few can be found off-world, at the Life Foundation colony on New Austin and working with American survey teams on Avalon but they are rare.

Unlike the human DNA modification project, dolphin uplift was never planned. Instead, it began as a project originated in the corporate boardrooms to produce aquatic workers. Before the advent of the merman DNAm, corporate engineers were looking for an inexpensive way to operate fish farms and other deep sea aquaculture sites. By 2109, the bottlenose dolphin genome was completely mapped and researchers were confident that they could boost dolphin capabilities to make more economically useful workers.

Two major changes were implemented to the bottlenose genome over the next 29 years. These affected the dolphin speech centres of the brain, along with the animal's vocal apparatus. While this improved the dolphins' **ability to communicate in human-range speech**, it adversely affected their ability to use echolocation to navigate and hunt prey. This limited their utility somewhat to the corporations that created them but it did make them more dependent on their human 'employers'.

For the next 20 years, neo-fins worked alongside humans on farms, tuna ranches and deep-sea construction projects. It was around this time, however, that DNA modification technologies were becoming much more advanced. A team of researchers at Tokyo's Maritime Aquatic Engineering Institute took it upon themselves to 'finish' the job for neo-fins.

The first new cadre of fins went to work on the Pacifica Farm Complex, one of the largest combined aquaculture projects in the world, in 2183. They retained the modified speech apparatus that allowed them to work with human languages. In addition, they got their echo-location back, along with improved night vision and gills that allowed them to stay underwater for up to six hours. Unknown to the researchers, their intelligence underwent a substantial boost as well, thanks to significant linkages between the echo-location centres of the brains and their overall intelligence.

In 2287, the 71 uplifted dolphins, along with another 200 neo-fins, staged a breakout from the Pacifica Complex. They disabled every single utility sub beforehand and made a clean getaway. The uplifted dolphins bred true, even with the neo-fins. Attempts to interbreed with wild dolphins were apparently unsuccessful.

Since then, the Uplifted dolphins have generally avoided contact with humans, although they have been known to raid aquaculture sites to free the neo-fin workers. The Life Foundation made contact with a group of uplifted fins in 2295 and offered to relocate them to their colony site on Austin's World. 75 u-fins accepted and have become an integral part of the colony.

Dolphins have the following Traits: Aquatic/2, Feral, Tough/1, Large, Echolocation/1, Weak Intelligence, Weak Soc. Uplifted.

*Name:* Poly-Tom STR 14 DEX 8 END 14 INT 6 EDU 2 SOC 3

*Age:* 16 *Career(s):* N/A (1 term)

*Skills:* Carouse 1, Hunting 1, Swimming 2

*Equipment:* Implant Radio

*Character:* Poly-Tom is one of the 75 u-fins that accepted the invitation to migrate to Austin's World. He is bright and capable but he does not like humans. He accepted the implant radio, however, in order to be of more use to his people and is seriously considering getting a neural jack.

*Motivation:* *Hearts 8, Clubs 6.* Poly-Tom loves his fellow dolphins and will do anything to protect them.

# THE PENTAPODS

Although truly more alien than any of the other races discovered to this point (with the possible exception of the Xiang), the Pentapods may turn out to be humanity's best friends. These amphibian bioengineers demonstrate a fascination with humans and are constantly seeking ways to be of service, especially in trading bioengineered products for human technology. There are those who suspect that they have a more sinister purpose, however and point to the invasive nature of much of the Pentapod technology designed for humans.

## FIRST ENCOUNTER

In 2251, the ARI sent a pair of survey vessels to DM+27 28217, a red dwarf just out from DM+36 2219 on the French Arm. Upon approaching the second of the system's three planets, the vessels encountered a globular organic-looking object, several hundred metres in diameter.

The ARI survey team included a xenobiologist and after a careful sensor scan, the xenobiologist and an assistant were sent in a small ship's boat to view the object up close. Upon approaching the object, the xenobiologist theorised that it was a vessel which was promptly proven when an opening appeared, allowing them entrance.

The object did indeed prove to be a vessel, the starship of a previously unknown race, the Pentapods. Peaceful contact was established and, by 2261, the Pentapods had gone so far as to establish an enclave on Beta Canum Venaticorum4, an important colony world further in on the French Arm.

The Pentapods have demonstrated an eagerness for trade and Humans were very willing to comply. The Pentapods provided bioengineered items such as living contact lenses and compasses and the Humans repaid them with land, raw materials and the services of a more mechanical technology. Soon, a fast friendship based upon mutually beneficial trade had developed. That friendship continues to this day.

It is worth noting that Pentapod society is broken up into many nations or Sects. Most of them view interaction with humans



in a positive light. However, many are also opposed and have threatened action if humans do not withdraw from Pentapod space.

### **Physical Description**

Pentapods are five-limbed amphibians standing at about one metre tall. The Pentapod head is a bulletshaped bony case housing the brain and the main sensory organs. Five eyes on stalks provide full circle vision and can be retracted into depressions in the skull. Five sensitive strips between the eyes respond to temperature and infrared light. The very tip of the head is pierced by a breathing hole leading through the skull to the body and lungs.

Attached to the skull with shoulder-like joints are the five legs; each is internally supported by three rigid bones and terminates in a fleshy pad (the pod or foot). Just above this foot are four fleshy tentacles or fingers, which perform grasping or manipulative functions. Between each of the five legs is a web of leathery skin. In the Pentapods' ancestors, this web connected all the legs down to the feet and was used when swimming. In contemporary Pentapods, the skin has receded to the first joint from the shoulder, allowing the limbs greater freedom of movement.

Humans perceive Pentapods to be creatures that have so blurred the division between living being and machine that they have lost the distinction. It is obvious that while many Pentapods fit the physical description here, others have been genetically tailored to fit a particular occupation. These tailored Pentapods often have extremities shaped as tools for their work or they might be small to fit into tight spots in machinery they tend or large to carry heavy loads. Even the Pentapods assigned to Human relations show evidence of design, including skin colours and textures pleasing to Humans. Each Pentapod is also mentally tailored to its occupation, demonstrating little interest in anything else but that job.

Humans realise that Pentapods view themselves as machines, each individual filling its niche in the overall Pentapod society. To humans then, Pentapods seem to be members of a race that, in the pursuit of biotechnology, sadly lost its identity as a collection of individuals. The truth is actually far stranger than that.

### **TECHNOLOGY**

Pentapod technology is almost wholly organically-based, however there are elements of mechanical and electronic technology in their society. The most notable of these is the stutterwarp drive itself, the 'mechanical displacement organ'. Starship weapons are likewise mechanical in nature, although in this case purchased from humanity. Other items incorporate only small pieces of non-organic material, like the antennas on radios.

**MOD:** Mod is a stat used by Pentapods to reflect how heavily-modified they are from 'base' Pentapods. The farther from the 'base' model they are, the lower their Mod characteristic.

**Traits:** Pentapods are Small, Fast/1, Swimmers, Fanatic/3 (their sect), have Peripheral Vision and Frequently (roll of 1-3 on 1d6) Manic

### **Typical Human Relations Pentapod**

Human relations Pentapods are engineered to have a more pleasing and soothing appearance and personality to humans.

*Name:* Tikka STR 5 DEX 10 END 7 INT 9 EDU 5 MOD 3

*Age:* 24 *Career(s):* Diplomat (3 terms)

*Skills:* Admin 1 Carouse 1, Diplomacy 3.

*Equipment:* Radio link (mod), biomonitor (mod), Human-made portacom

*Character:* Tikka acts like he just came off an assembly line. Very bright, friendly and helpful, he does not have much knowledge of the world outside his specialty. He is very curious about humans and human technology but possesses very little interest in anything else.

*Motivation:* Hearts 3, Spades 5. Tikka is motivated by friendliness and curiosity.

## **THE PENTAPOD FINGER**

This branch of space has been poorly surveyed, since no human ships are permitted to journey past the Pentapod trade station at DM +41 2147. The Pentapods lack the naval force necessary to enforce any quarantine, so they have made a strongly-worded diplomatic request. Civilian ships that do not honour this request have been known to disappear.

It is known that there are at least a couple of Pentapod colony worlds in the Finger, in addition to the homeworld but little is known about them. It is worth noting that Pentapod requirements for habitability are not the same as humanity's.

### **NOTABLE SYSTEMS**

#### **DM +41 2147**

The second planet of this system is a hot, dry world barely capable of supporting life. The Pentapods have established a station in orbit around the world and use it as the base for trading expeditions into human space. Human merchants are likewise welcome here but few choose to actually stay in the immense, slowly rotating blob of the station for any length of time. Practically any Pentapod biotech device is available here, although prices will be wildly variable. At least two Pentapod *VoidShark* vessels patrol the immediate environs of the station, along with a multi-national (French, German and British) taskforce.

Travel further up the Finger is not permitted.

#### **DM+43 1953**

This world is the home of the Pentapods. The first human visit to this system will be the exploratory starship *Bayern*, as it starts its journey towards the Pleiades. The *AIB* worked with the French and German governments to secure permission to travel this way as it begins its monumental journey to the Pleiades star cluster, 400 light years away.

## HOMEWORLD

The Pentapods hail from the first of two worlds in orbit around DM+43 1953, a small orange star.

## PLANET DATA

UWP: C64A872-C Wa, Ri

Name: Lifewater

Distance from Primary: 0.77 AU

Year Length: 262.58 days

Size: 8,800 km in diameter

Day Length: 17.32 hours

World Type: Garden

Surface Gravity: 0.69 G

Atmospheric Pressure: 0.74 atm

Climate: Warm

Water Presence: 95%

Atmospheric Composition: N<sub>2</sub> (74%), O<sub>2</sub> (21%), CO<sub>2</sub> (2%)

The Pentapod homeworld consists of several hundred small but very deep, circular seas separated by thin bridges of marshy, boggy soil, with only a few mountains or rocky ground. The surface of the world is the result of thousands of years of manipulation and fine-tuning by the world's dominant inhabitants, the Pentapod gods. Each circular sea is the home of a different god, carved out and reshaped by armies of servitors created by each massive being.

## THE SUNG

The Sung were the first sapient alien race to be discovered by humans and in many ways they bear the most similarities to humans in culture and thought processes.

## The Sung Home System

### STELLAR DATA

Primary Name: DM +4 123

Spectral Class: K2 V

Magnitude: 6.55

X, Y, Z Coordinates: 22.0, 4.4, 1.9

Number of Planets: 5 (Nivix'dal, Kag'rok, Stark (Vasshon), Haz'rok, Jitok)

Number of Asteroid Belts: 0

**Notable Planets:** The gas giant, Jitok, is a super-Jovian world roughly four times the size of Jupiter and puts out a great deal of heat from its own internal processes. The largest of its moons, Home of the Mother, is the homeworld of the Xiang race. This is in addition to the 27 assorted chunks of rock and ice orbiting this massive planet.

### Homeworld

Name: Vasshon (Stark)

Distance from Primary: 0.87 AU

Year Length: 251.5 days

Size: 10,990 km in diameter

Day Length: 27.61 hours

World Type: Garden

Surface Gravity: 0.93

Atmospheric Pressure: 1.01 atm

Climate: Temperate

Water Presence: 69%

Atmospheric Composition: N<sub>2</sub> (76%), O<sub>2</sub> (21%), Trace (3%)

The Sung hail from Stark, the third world in orbit around DM+4 123. It is a world slightly smaller than Earth and with a somewhat lighter gravity, yet still in the range of 'Normal.'

## Stark

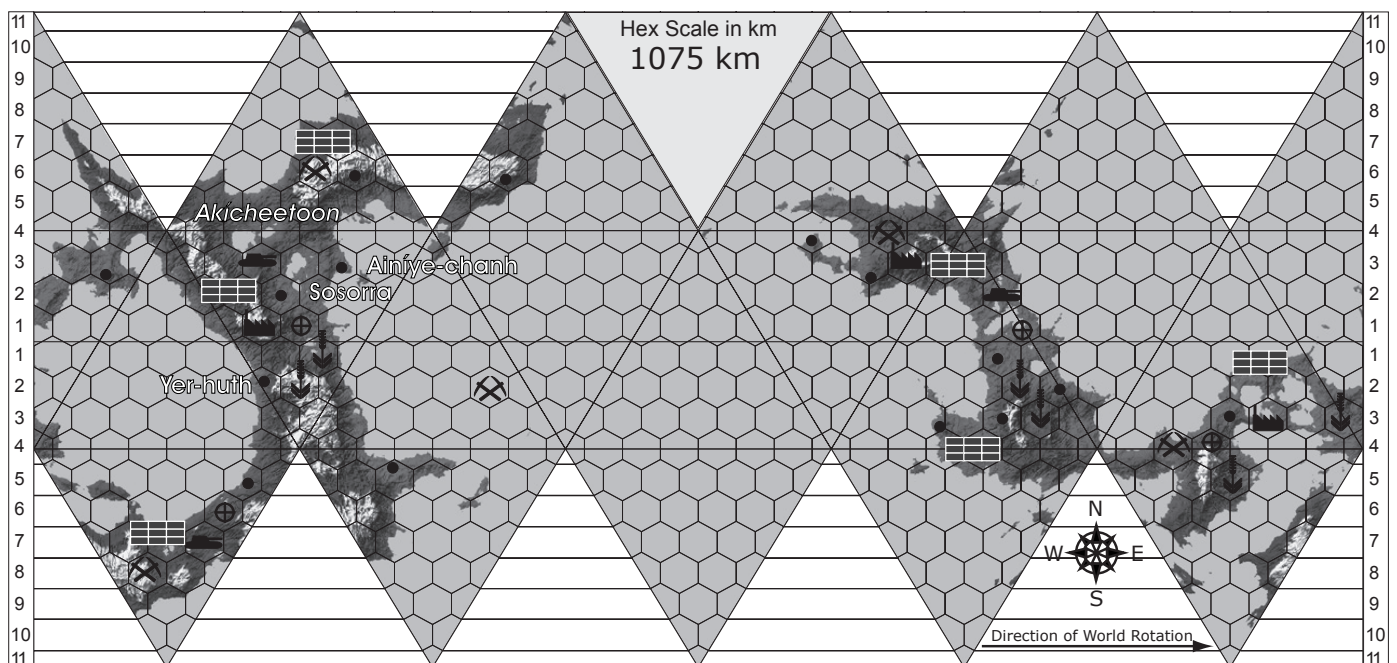

## FIRST ENCOUNTER

Discovered by a Manchurian exploratory mission, the Sung were first encountered in 2247 in their home system. First contact occurred when the Manchurian expedition, investigating mysterious signals from the system's third planet, detected a Sung interplanetary craft. Assuming that the source of the signals, as well as the ship, was some unexpected human expedition, the Manchurians attempted communication. The signals that returned were obviously non-Human and the Manchurians panicked and fled from the system. They returned directly to Earth, with the news that there were technologically advanced aliens at the fringes of the Chinese Arm.

Another Manchurian expedition was quickly sent back out. This time, it consisted of a party of warships (in case the aliens proved hostile) carrying teams of exobiological, linguistic and diplomatic experts. Remaining in the outer regions of the system (so as not to appear a threat to the Sung homeworld), the expedition was successful in initiating peaceful communications with the Sung. Progress continued until a Canadian group discovered the Xiang, another sapient race native to the system, who appeared to be slaves of the Sung. When news of this reached Earth, an outcry was raised leading to the Slaver War.

Sung interplanetary vessels were no match for human stutterwarp warships. With very little loss of Sung lives, human dominance was accepted under the system of *SosSoonAtkacharr*.

Sos-Soon-Atkacharr is one of the underlying principles of the Sung social order. Under this idea, more advanced societies are obligated to raise less-advanced cultures to their level. In return, however, the more-advanced society is entitled to payment for its efforts, in the form of labour, resources or both.

It was the system of *SosSoonAtkacharr* that the Sung had used to justify their treatment of the Xiang. In Sung eyes, the Xiang were primitives and they were expected to obey their Sung masters, in return for which they were given access to Sung knowledge. It did not matter to the Sung that the Xiang did not desire that knowledge, in fact, that was so much the better, as it meant that Sung business would continue into the distant future on Xiang labour. With the human conquest, humanity is now the dominant nation and has a duty to raise the Sung nations up to its level. In Sung eyes, this largely means the secret of the stutterwarp.

Since the end of the Slaver War, relations between Sung and humans have steadily improved into a system of fairly free co-operation. The only frictions still to be felt concern the reluctance on the part of humans to share stutterwarp technology and other advanced information. To the Sung, this reluctance constitutes a violation of the system of *SosSoonAtkacharr*, which states that the dominant state must share freely with its subordinates. Even though the Sung realise that humans are alien, deeply ingrained cultural systems die very hard.

## PHYSICAL DESCRIPTION

So far, the Sung are the only sapient race yet discovered by Humankind that is capable of natural flight. When standing as straight as possible, the typical Sung has a height of approximately 120 centimetres but as Sung posture is slightly stooped, they appear to be even shorter. Sung wings, located midway between a pair of forelimbs and a pair of back limbs, have a span of about five metres and taper down to the tips. Sung forelimbs are small and delicate, while the back limbs are strongly muscled and sturdy.

The Sung head and tail are designed to aid in flying. The well-muscled tail has a fanlike stabiliser at the tip, which can be retracted when the Sung is on the ground. A rigid crest, located on the top of the Sung skull, functions as a small 'rudder'. The Sung head has four eyes, one pair above the other, with the lower pair being the larger and more widely spaced. Sung bodies are hairless and their skin is soft and supple.

## Society

The hierarchal system of *SosSoonAtkacharr* plays a crucial role in the structure of Sung society, which is organised into a system of nationstates. A state with technological or cultural dominance fills a leadership role in which it demands obedience from lesser states in its sphere of influence. The superior state, however, has an obligation to raise its subordinates to its level through educational and financial assistance. The pattern of ascendance to superiority proves to be cyclic in nature, with the superior status leapfrogging from one state to another as advances are made.

Technologically, the Sung are roughly comparable to Humans. In some areas, such as medicine, they are more advanced; in others, such as star travel and power generation technology, they are at a lower level. At first contact, Sung had developed interplanetary ships equipped with both magnetic sails and ion drives.

*Traits:* Sung are Flyers, Disease Resistant/1 and Robust/1, Acute Senses (sight), Sensory impaired (smell/taste), Annoying Traits (persist in bugging humans about their technology) and Small.

## Typical Sung Trader

*Name:* Cassel STR 6 DEX 9 END 12 INT 9 EDU 9 SOC 10

*Age:* 32 *Career(s):* Free Trader (4 terms)

*Skills:* Admin 1, Astrogration 1, Athletics (Flight) 4, Broker 1, Steward 1, Zero-G.

*Equipment:* Comm, Clothing, Computer

*Character:* Cassel is the Sung equivalent of second-mate aboard a plasma-drive slow boat that travels between several worlds and habitats in the Sung system. He resents humans for not having transferred stutterwarp technology to his people, as they were obligated to do under *Sos-soon-atkacharr*. He wants the stars for his people.

*Motivation:* *Diamonds 4, Spades 9.* Cassel desperately wants to see other stars and other worlds and make a fortune while doing so.

# THE XIANG

Of the known sapient races, the Xiang are the most technologically backward. However, this masks the fact that a very high intelligence lurks within the Xiang's spidery form.

## SYSTEM DATA

The Xiang inhabit the same system as the Sung and further information on the system is provided in the Sung entry.

## Homeworld

The Xiang homeworld is a moon orbiting DM+4 123's fifth planet (a gas giant).

*Name:* Home of the Mother

*Distance from Primary:* 710,000 km

*Year Length:* N/A

*Size:* 9,900 km in diameter

*Day Length:* 78 hours

*World Type:* Garden

*Surface Gravity:* 0.76 G

*Atmospheric Pressure:* 0.81 atm

*Climate:* Temperate

*Water Presence:* 71%

*Atmospheric Composition:* N<sub>2</sub> (79%), O<sub>2</sub> (19%), Ar (2%)

*Biodiversity:* Diverse

## FIRST ENCOUNTER

There were a few Xiang in evidence on the Sung homeworld when humans first arrived but the Sung did not mention their intelligence and, without the evidence of technology or the knowledge of their ability to speak, humans assumed that they were beasts of burden. When a human research team finally reached the Xiang homeworld, however, Xiang art convinced them that the race possessed at least nominal intelligence. A few experimental contacts soon proved that the Xiang were as intelligent as human beings but with no desire for advanced technology.

The fact that the Sung had great strip mines on this beautiful moon, where they worked the nature-loving Xiang, soon led to an outcry of 'slavery' among humans. The Sung justified themselves by the system of SosSoonAtkacharr, saying that it was only natural that the technologically primitive should serve the advanced. In return, they offered the Xiang the benefits of Sung knowledge and technology. They did not see it as their fault that the Xiang did not desire those benefits.

Humans disagreed with this view and the Slaver War was born, ending in the breaking of Sung power over the Xiang and the establishment of Human power over the Sung.

## Physical Description

In structure, the Xiang are similar to Terran arthropods, particularly the crustaceans, although they are more like arachnids in appearance. But their world's lighter gravity has allowed them to attain a much larger size than their Terran counterparts. The Xiang body is covered by a tough carapace and consists mainly of a horizontal main portion that contains the internal organs and is supported by eight of the Xiang's 10 segmented legs. The other two legs can also act as manipulator arms and are most

often used that way. At the rear, a small, segmented tail curls under; at the front, a head holds the mouth and primary sensory apparatus. The average Xiang stands about one metre tall and is one metre in length.

The Xiang head is dominated by two large, bulging eyes, one to either side of the head. Between them runs a line of four vestigial eyespots, surmounted by another, slightly larger pair. Just below the row of eyespots is the creature's mouth, externally a strong beak for cutting, surrounded by four tiny arms, each with a pair of digits for holding food.

### **Society**

The symbiosis between Xiang and dirtmother has led the Xiang to have consuming concern for the balance of nature. Being the largest predators on their Eden-like planet, the Xiang have no need to construct weapons. Their stimulus to intelligence has been the need to find sufficient food while remaining in a fixed geographical location. The Xiang are not terribly fast creatures; instead, they have used their intelligence to become consummate trappers.

The Xiang also display a great love for artistic expression. This and their trapbuilding skills combine in the creation of beautiful sculptures with which they decorate their surroundings. Xiang also show a love for storytelling and music, the latter produced both by their bodies and by a few simple instruments they construct.

**New Stat:** DIR (Dirt Mother) is a measure of how closely tied the Xiang is to its dirt mother. This governs its interactions with others, as well as determining the distance, in kilometres, it can bear to be separated from the dirt-mother.

**Traits:** Xiang have the following Traits: Ugly (to humans), Fast/2, Eidetic Memory, Double-jointed, Ambidextrous, have Nightvision, Acute Senses (Smell/Taste), Dependent, Fanatic /3 (both apply to dirt mother) and Feral.

### **Typical Xiang Artist**

**Name:** Kikitik-tihaklal STR 9 DEX 13 END 8 INT 8 EDU 2 DIR 5

**Age:** 24 **Career(s):** Artist (4 terms)

**Skills:** Art 2, Recon 1, Stealth 3, Survival 2.

**Equipment:** Weaving sticks, dyed arthro silk

**Character:** Kikitik-tihaklal is a weaver, currently in the early female stage of her life-cycle. She cannot bear to be more than five kilometres away from her dirt mother. In addition to her weaving, she spends a great deal of time working with humans, trying to figure them out.

**Motivation:** Hearts 8, Spades 5. Kikitik-tihaklal loves and needs her dirt mother and that motivation is foremost in her mind. She is also intensely curious about humans and the world they represent.

## THE KAEFERS

Implacable, violent and frightening, the Kaefers are a great mystery to the humans of 2300AD. Their name is a corruption of a German word, meaning 'bug'. To the French, they are 'les cafards', to the Texans of Tanstaafi 'roaches' and the Ukrainians call them 'Rukh'.

### **HOMEWORLD**

The location of the Kaefer homeworld is currently unknown.

### **First Contact**

Humanity's first contact with the Kaefers came in 2295, when several vessels entered the Arcturus system from outside Human space. The French research station orbiting the star attempted to make contact, broadcasting greetings in several languages. The alien vessels did attempt to respond but the language gap was too wide. After a couple of days the alien vessels withdrew back into unknown space.

Three years later, the aliens returned. This time, they attacked and captured the station, then swept on to attack the nearby colony world of Aurore. Human forces eventually drove the aliens off but not before they landed several thousand troops on the beleaguered colony world. The past two years have been spent in vicious ground actions to eliminate the invaders, who committed atrocities on the human populations after the initial landings.

### **Physical Description**

The Kaefers are an upright, bipedal, roughly humanoid creature approximately two metres tall. They have a vaguely insectoid appearance, enhanced by the large carapace on their backs, the bristly, hairlike projections on their forearms and lower legs and their vertical lobster-like mouths, which consist of a complicated arrangement of mouthparts between two large, powerful mandibles.

They are implacable in combat, neither offering nor accepting surrender. Their behaviour in combat is unpredictable as sometimes they are ineffective and other times they are cunning and deadly. Their officers have been observed to beat their soldiers, forcing them into battle. At this point in time, very little is known about these creatures.

## OTHER RACES

There is some archaeological evidence for the existence of other aliens, even star-faring ones. However, there is very little conclusive evidence.

# CYBERNETICS AND DNA MODIFICATIONS

While most surgical, chemical and bionic enhancements are largely legal in the 24th Century, few elect to have these invasive procedures performed. The drawbacks of these augmentations often outweigh the benefits. Cybernetics are usually obvious and attract attention, while chemical therapies have their own drawbacks. Then there are the risks of surgery itself, the upkeep requirements and the ever-present risk of infection. Only those who truly have a need will go to the lengths required.

## PROSTHETIC VS. BIONICS

A distinction has to be made between prosthetics and bionics. Prosthetics are designed to duplicate the functionality of the original body part, while bionics are designed to augment it. Prosthetics are perfectly legal, while bionics are controlled.

Some do bother, however, whether they are the augmented agents of a TransNat or the servant of a national government or even a terrorist intent on sweeping aside the old order.

Few go to the trouble and expense of bionic and prosthetic modification unless they have a burning need for it. The only exception to this tends to be the military, where a prosthetic replacement for a damaged limb is quite common.

The various prosthetics, therapy and bionics presented here are for a 'low-cyber' style of game. The Referee may modify the price to best suit the sort of campaign he wishes. Likewise, the side-effects from many of these implants make them unpalatable to most players and the Referee is free to modify them as he sees fit to work with his game.

## THE BLACK CLINICS

The Black Clinics are a sort of urban legend in the world of 2300AD. Everyone has heard of them, knew a friend of a friend of a friend but no one has actually been to one. They do exist but are very rare. One would require extensive underworld contacts to ever have a chance of tracking one down. If one was able to, however and had the Livre, then they can provide just about any kind of augmentation imaginable. Most of the Black Clinics have links to ProVolution and so one can never be certain that they are getting exactly what they asked for.

## The Mongoose Traveller Cybernetics Book

Most of the options available in the *Cybernetics* book are available in 2300AD, at approximately 10% of the listed price. What follows here is a sample of the more common augmentations in the setting. For the purposes of cybernetics and biotech, the 2300AD setting is considered to be TL14, rather than TL12. In terms of genetic engineering, TL16 is fairly common.

Despite the Tech Level, the more extreme forms of cybernetic augmentation are unknown. Borged-out warriors tend to find a quick end at the hands of police snipers and combat walkers. They also have trouble being allowed on spacecraft and starships, unless their augmentations are turned off.

There are three types of modifications available: Surgical, chemical and bionic/prosthetic.

## SURGICAL AND BIONIC/PROSTHETIC MODIFICATIONS

### Cybernetic and Surgical Modifications

The installation, recovery and 'learning' time (the time it requires to adapt to using the cybernetic augmentation) differs according to the cybernetics and Tech Level. The Installation table shows the amount of time, in weeks, that installation, recovery and learning takes at TL 8. Every TL above 8 reduces the time by one week, to a *minimum* of two weeks.

#### Installation Table

| Augmentation Type                                    | Installation, Recovery and Learning Time |
|--|--|
| Single Arm   | 1d6+3 weeks                              |
| Both Arms  | 1d6+6 weeks                              |
| Single Leg   | 1d6+6 weeks                              |
| Both Legs  | 1d6+8 weeks                              |
| All Limbs  | 1d6+10 weeks                             |
| Sensory organ (eye, ear, nose)                       | 1d6 weeks                                |
| Major internal organ (heart, lung, kidney and so on) | 1d6+2 weeks                              |
| Minor internal organ                                 | 1d6+1 weeks                              |

## Installation Facilities

Installing cybernetics or surgical modifications of any kind is not an off-the-shelf process. The machinery or vat-grown tissue must be ordered and manufactured prior to surgery: this takes a number of weeks equal to the Installation, Recovery and Learning time, reduced, again, by one week for every TL above 8. At TL 12 it may be the case that off-the-shelf cybernetics are available without build time but this is for individual Referees to determine.

Surgery must be carried out at a facility equipped to do the work. The nature of the facility determines if there is any modifier to the Installation, Recovery and Learning time; apply this modifier to the time determined by the Installation Table time.

At lower Tech Levels and at lower quality facilities there is always a risk, too. Any surgery to install cybernetics or surgical modifications requires a Survival roll. The level of the roll is summarised in the Installation Facility table. If the roll is failed, the character must immediately roll on the Injury Table on page 37 of the *Traveller Core Rulebook*.

The character gains a +1 DM for every TL of the facility above TL 8.

# SURGICAL MODIFICATIONS

Surgical modifications closely overlap with bionics; the main difference is that surgical modifications tend to use implanted biological material rather than mechanical assists.

## Muscle Implants (TL10)

This technique involves taking a muscle tissue sample from the character and culturing it in a collagen tank, then grafting these new muscles into the existing tendon/ligament system of the character. The technique will give the character the Powerful Trait, with a cost of Lv10,000 per level. Maximum level is Powerful/3. Each level of Powerful will temporarily reduce Dexterity by two points. The character must make a Routine Dexterity check each week, with success reducing the Dexterity penalty by one point.

Cost: Lv10,000 per point of Powerful.

## Neural Sheathing (TL11)

This technique utilises viruses that have been engineered to manufacture and deposit certain organic chemicals around the nerve fibres of a character. The plastic-like sheath decreases the electrical resistance of the nerves and various outside electrochemical interferences to neural communication. To perform the process, a doctor takes samples of blood, nerve tissue and spinal fluid from the patient and determines what support chemicals are required for the viruses to perform properly. The process must be monitored for one full month, with a medical appointment every three days to update the support solution.

The doctor *must* succeed in 10 successive Routine Medical Checks. For every day the character is late for an appointment, the doctor's target goes up one level (Routine to Average, Average to Difficult and so forth), so it is important to be prompt for appointments while undergoing this treatment.

If the Medical check is failed by more than four points the sheathing is lost but the process can be retried. If the roll fails by more than six points, the character permanently loses one Dexterity point and the process cannot ever be retried, as the character's nerves are permanently coated in a mass of what is technically termed 'goo'.

If the process is totally successful, then the character receives the Fast/1 trait. If the character already has the Fast trait, then add one to Initiative and four metres per round to speed.

Cost: Lv6000.

## Neural Sheathing, Improved (TL12)

Improved neural sheathing adds medical microdrones to the process to help regulate and direct the sheathing process. Instead of 10 Skill checks, the doctor performing the process must make only five checks, although the Difficulty remains the same. For every two days a character is late, the doctor's target goes one level rather than every day and failure will never result in the dreaded 'goo'.

If the process is totally successful, then the character receives the Fast/2 trait. If the character already has the Fast/2 trait, then add one to Initiative and four metres per round to speed.

Cost: Lv12,000

## Installation Facility Table

| Facility                               | Modifier to Installation, Recovery and Learning Time | Survival Roll |
|--|--|---------------|
| Teaching Hospital                      | 0  | End 5+        |
| Frontier Hospital                      | +1 week  | End 6+        |
| Specialist Cybernetics Hospital/Clinic | -1 week  | End 4+        |
| Military Hospital                      | -1 week  | End 4+        |
| Good quality private clinic            | 0  | End 5+        |
| Medium quality private clinic          | +1 week  | End 6+        |
| Poor quality/backstreet/illegal clinic | +1 week  | End 7+        |
| Black Clinic                           | -2 weeks   | End 4+        |

## Chargers (TL12)

Chargers are devices that are used to store some of the endorphins that the character's body naturally produces. The endorphins are saved for reintroduction into the body when needed to add extra oxygen to and remove fatigue toxins from, the character's bloodstream. The charger is installed in a space made by removing all or part of one kidney. Chargers grant one or more Traits based on the type of charger installed. A supercharger gives the Hard to Kill/1 trait (and requires removal of half the kidney); a hypercharger gives the Hard to Kill/2 trait (and requires removal of an entire kidney). Ectomorphs may not have a hypercharger installed, due to the comparative bulk of the unit. Use of either the supercharger or hypercharger causes the subject to sweat profusely, with a sharp odour.

Cost: Supercharger Lv4,000, hypercharger Lv 7,000

## IMPLANTED WEAPONS

It is possible to implant several different types of weapons, mostly melee weapons but Pentapod biolasers have been found in the hands (literally) of terrorists and criminals in many parts of human space. They are extremely illegal and possession of these weapons is often sufficient provocation for police and security forces to engage in pre-emptive self-defence. Implanted weapons include:

*Hand Razors: (TL 11)* Implanted into either a flesh or cybernetic hand, the razors extend on command. Typically the command is a difficult hand or finger movement. User is considered to be armed for attacks of opportunity.

Damage: 2d6

Price: Lv2,000

*Wrist Blades: (TL12)* Larger than the razors, wrist blades are implanted in a sheath which runs up along the top of the forearm and they are detectable through physical examination of the arm. User is considered to be armed for attacks of opportunity.

Damage: 3d6

Price: Lv5,000 (black market only)

*Cyberlimb Weapons: (TL10)* Firearms can be installed into a bi-ionic limb. An arm can hold handgun weapon, while the leg can hold a large pistol or small machine pistol. The leg mount can be either a holster or else an actual firing mount, in which case it receives a -2 DM To Hit due to the awkwardness.

Price: Weapon cost x 3 + Lv5,000

## CHEMICAL MODIFICATIONS

Although they are tightly controlled, chemical therapies are more accessible than most other types of augmentation.

### Vasopressin-Y

This drug allows the human brain to modify its electrical pathways, which will make it easier for a character to learn new things and recall what he has already learned. Due to its addictive effect, this drug is usually used by people who are beginning major projects and can quit after the project's completion. The drug must be taken in a daily dose for two full weeks for any effect to occur, at which time the character's Intelligence score will be raised by 1d6 points and they will gain the Eidetic Memory trait. If the character remains on the drug for one month or less, he will suffer no side effects. For every month thereafter that the character remains on the drug, he will suffer the loss of one point of Endurance, regained at the rate of one point per week after no more Vasopressin-Y has been taken. If a character's Endurance reaches zero, he will slip into a catatonic state. To quit taking Vasopressin-Y, the character must roll for the following save:

*To Beat Vasopressin-Y addiction:* Difficult Endurance check. This can be re-rolled once per week. This roll applies whenever the character wishes to stop taking the drug.

The drug is bought in weekly doses, which cost from Lv50 per week's dose in the Core to Lv200 in the Arms. Due to the dangers inherent in this drug, it is illegal in many nations/systems and its cost there is 100 x the nation's UCP Law Level.

### Tesseron Beta-Five

Tesseron Beta-Five is a drug that stimulates the endocrine system, causing increased production of strength-producing hormones. It is administered in a weekly dose and must be taken continually to keep up its effect. When a character first takes T-Beta-5, it will have no immediate effect. Upon taking the second dose, the character must make a Routine Endurance check or his body will reject the therapy and he will be unable to continue. With the third dose, the character will gain between one and three points of Strength (1d6/2). This added Strength will drop by one point per week, unless further doses of the drug are taken to maintain it at its present level. Additional doses will not improve Strength further.

Should a character decide to quit T-Beta-5 after more than two weeks of use, he will suffer some withdrawal effects. Each week



when the character's enhanced Strength drops by one point, the character will also lose one point of Dexterity due to muscle twinges. Once the character's enhanced Strength has worn completely off, his Dexterity will begin increasing by one point per week until it reaches its natural level.

The cost per dose can range from Lv50 at the Core to Lv300 deep in the Frontier.

## CYBERNETIC/PROSTHETIC MODIFICATIONS

One of the results of increased knowledge about the workings of nerve cells has been the development of a technology by which human nerves can be linked to electronic devices. In this way, the biochemical process of a thought can be translated into action by a machine. This technology is most valuable in allowing the control of prosthetic limbs and bionic replacements such as eyes and ears. Another, somewhat less valuable use of this technology is the neural jack.

### **Neural Jack**

When it first appeared in the late 2280's, the neural jack was hailed as the ultimate tool in ridding humanity of the constraints of the body. It is an electronic socket wired to a person's brain, allowing a person to plug cable connections into a piece of equipment in order to control that equipment by thought. Now machinery could be controlled as if it were part of the user's own body. Computers could respond at the speed of thought, allowing input without the cumbersome interference of the user's body.

When jacked into a piece of equipment, a character's control of that equipment will be both quicker and more accurate than if he were using manual controls. A jacked character receives a +2 bonus to any Skill checks involving the use of the equipment and in the case of vehicles, a +1 to Initiative checks while jacked in. The major drawback to being jacked is that the character is so tied into the equipment's control system that he becomes almost insensible to control of his own body. Any skill checks requiring the character to use his own body while jacked into a piece of equipment have a -4 DM attached to them.

Another drawback of jacking is the relative lack of equipment to plug into. Very little equipment comes with the cybernetic linkages installed. Most have to be either ordered custom-made or the linkage servos and sensors have to be installed after the fact. This costs roughly 50% more than the standard price. Aircraft and spacecraft, being largely wired already, only cost an additional 10% to be equipped with the linkage equipment. Military starships are the most likely items to be fitted, with approximately 25% of them equipped for linkage in some form or another. All military spacecraft built since 2295 have neural interfaces.

Weaponry is a special case, as any firearm can be equipped with a dual set of linkages, one of which controls the trigger while

the other feeds targeting information directly to the optic nerve in much the same way as a virtual display. This gives the benefit of a built-in HUD (+2 to hit) along with granting the character in question +1 on Initiative, while using that weapon only. Using a weapon in this way does not require the Intelligence check, as the linkage simply hijacks the command from the brain to pull the trigger and uses that impulse to fire the weapon.

The cost of having a neural jack installed in a character is Lv12,000. At the time of installation the player must decide where the jack will be located on the character, the most common places being at the temple or on the forehead (for ease of access) or in the hollow at the nape of the neck (where it can be hidden by hair or clothing).

### **BIONIC REPLACEMENTS**

Most crippling injuries in the 24th Century can be simply repaired by growing replacement tissue from the patient's own cells and then grafting it on. Entire limbs and organs can be repaired in this way. This process takes about a month and the surgery is straightforward as there is no possibility of rejection.

But some sources offer prosthetic replacements for those who prefer them to the real thing. Prosthetics, while they lack the subtlety of tactile sensation that real organs and limbs give, have many tempting advantages over their flesh-and-blood counterparts. Prosthetic limbs do not tire as easily as natural limbs, nor do they feel pain as more than an abstract sensation. Bionic eyes and ears can offer enhanced senses.

Prosthetics are not illegal and are defined as mechanical medical replacements that do not extend the user's capabilities more than the original. Bionics, however, do extend the owner's capabilities and if they violate local laws, must be registered with national police services, at a cost of Lv1,000 per point per year. So a character with a Strength of 7 could get a Strength 7 cybernetic arm with no difficulty and in America (law level 8) could get a +2 boost with no difficulty. A +3 boost, however, would need to be registered which would cost Lv3,000.

### **BIONICS AND LAW LEVEL**

Bionics are limited by national or colonial Law Level. Bionics may increase a user's physical capabilities by 10-Law Level. A result of 0 or lower is still 0. Results of 0 indicated that strength-boosting is not allowed.

Although not illegal, governments and foundation tend to discourage the use of even prosthetic devices, due to fears that the users could become dehumanised from the effects of using the mechanical limbs. Many psychologists feel that those fears are largely groundless but the debate rages.

Prosthetics tend to be more common in military circles, as re-growth therapy takes too long and is too specialised for field surgeries. A soldier who loses a limb can be in action in as little as month with a prosthetic, versus 2-3 months for a regrown limb including any retraining time.

## FULL CYBORGS

Full cyborgs, where the entire body has been replaced by mechanical systems, are very rare in human space – there are only 61 known. All of them are accident victims where regrowth/regeneration failed for one reason or another. Most of them are concentrated on the Core Worlds, which have the resources to maintain their artificial bodies. Full body cyborgs would normally be designed with the rules found in the *Cybernetics* sourcebook.

Cyborgs can also be designed as vehicles, with one space set aside for the central nervous system and support systems. They require daily nutrient, mineral and vitamin supplements for their biological components (the brain, primarily), along with a power recharge/refuelling. Otherwise, use the rules from *Cybernetics* to design a full-body cyborg. There is one example of a full-body replacement in the NPCs chapter of this book, see page 279.

## TYPES OF PROSTHETIC/BIONIC MODIFICATIONS

### Bionic Eyes

Bionic eyes are a very common modification, because of their usefulness. As poor eyesight is often genetically-based, simple regrowth techniques generally will not help and genetic tweaking is quite expensive. In comparison, bionic eyes are relatively inexpensive and offer perfect vision that will not fade with time. Bionic eyes also lack the power and maintenance problems of bionic limbs and the infection issues of neural plugs. Most bionic eyes are fairly easy to detect as they tend to be a standard shade of blue, brown or grey. Many also have the lensmaker's logo neatly printed around the iris in tiny script. Some are shades that no human eye will ever be but it is possible to obtain eyes which appear to be completely real. There are several option packages available for use with bionic eyes, each of which must be purchased at the time of installation. Bionic eyes automatically come with the Acute Sense (Vision) Trait.

*Price:* Lv3,000

*Colour Enhancement:* This option allows the user to see things in computer-enhanced colour or black and white. Colour enhancement makes it easier to spot camouflaged targets and to observe fine detail.

*Price:* Lv500.

*Low Light:* This option allows infrared vision in low light environments, like biocontacts.

*Price:* Lv650

*Flash Proof:* This option protects the owner's vision from sudden flares of light, giving him the same protection as photosensitive goggles.

*Price:* Lv300

*Optic Imager:* A favourite of espionage agents, this option lets a person take five high-resolution pictures on thought command

and review them later. If the person has a neural jack, he may transfer the pictures to a high-resolution chip. Another option is to transfer them to a subdermacomp, which can hold thousands of images. To erase the pictures, the user simply records over them.

*Price:* Lv1,000

*Subtlety:* This option makes it almost impossible to detect that the user's eyes are bionic.

*Price:* Lv850

### Bionic Ears

Bionic ears are an uncommon modification but enjoy a certain appeal with the avant-garde. One of the drawbacks of the low-frequency and high-frequency features is that they make the ear obviously artificial in shape and/or material. Bionic ears automatically come with the Acute Sense – Hearing Trait.

*Price:* Lv4,500

*Low-Frequency Hearing:* This option enables a person to hear sounds below the range of normal humans. Ears with this option do not appear normal – they tend to be larger and, although constructed of cartilage and flesh, they are often of an unusual shape (pointed at the top, for instance). These ears are popular with researchers studying the Eber, as it allows them to hear in the low-range that is part of the Eber aural spectrum. +2 on all applicable Checks involving sound.

*Price:* Lv600

*High-Frequency Hearing:* This option allows a person to hear sounds above the range of normal humans. Ears with this option also do not appear normal – they are usually of relatively dense materials such as plastics or even metals. +2 on all applicable Recon Checks involving sound.

*Price:* Lv600

*Sound Dampening:* Although loud or irritating sounds will not damage the bionic ears in any way, they can be unpleasant to the user. This option enables the owner to dampen out specific ranges from the sonic spectrum, allowing sound to be dampened, which can also make it easier to hear a specific sound (such as someone's voice) in a noisy environment.

*Price:* Lv250

*Recorder:* This option allows the user to record 10 hours of sound and play it back at a later time. The recording can be accessed at any point and can be recorded over. The recorder option is especially popular with students and music fans. Recordings can be downloaded via neural jack or dumped to a subdermacomp.

*Price:* Lv450

### Bionic Limbs

Bionic limbs come with a standard Strength of 7 but can be improved up to a maximum of 16. In most task rolls using Strength as a modifier, a character's normal Strength should be used but if the Referee judges that a particular task warrants it, the Strength of the bionic limb can be used instead. For example, if a character is

attempting to lift a heavy weight from the floor, his natural Strength should be used, since all of his limbs and his torso muscles are involved. If, on the other hand, the character is hanging from a ledge by his bionic arm, the Strength of the arm should be used in determining whether or not he can hold on.

As there is some empty space in most bionic limbs, it is possible, although illegal, to have a secret compartment built into one. A bionic arm can have a compartment 20 centimetres long and three centimetres in diameter, a bionic leg can have a compartment 30 centimetres long and eight centimetres in diameter.

*Price:* Lv10,000 for a Strength 7 bionic arm, plus Lv1,000 per extra point of Strength; Lv12,000 for a Strength 8 bionic leg, plus Lv600 per extra point of Strength. A cybernetic hand is Lv4,800, as the hand is the most complex part of the arm, while a bionic foot is usually only Lv500, although that foot has only limited function. At the base Strength rating, these limbs are considered prosthetics, although added Strength makes them Bionics.

*Equipment:* Rather than having a secret compartment, a bionic limb may be constructed with any one-handed piece of equipment built into it. A one-handed firearm can be built into a bionic arm (although it is highly illegal) but is seldom built into a bionic leg, due to the fact that it would be nearly impossible to aim. The extra cost for such equipment is five times what the equipment would normally cost.

*Power:* Bionic arms and legs require a power source, typically contained within the limb itself. This power supply is usually a compact super-battery, which can supply power to the limb for up to 96 hours of constant use. These batteries can be recharged from any standard supply, including household current and portable generators. The battery itself weighs two kilograms and costs Lv50.

*Maintenance:* Bionic legs in particular require a considerable amount of maintenance and tuning. Each bionic leg requires six hours of maintenance per month. For each month missed, the character suffers a penalty of -1 to all moving actions and their speed drops by one metre. Bionic arms require less maintenance, only two hours a month but still suffer the -1 penalty if the maintenance is missed. Note that this penalty is cumulative for each month missed and the maintenance time must be made up before the penalty goes away. So if Jeff misses three months on his bionic leg, he is at -3 on all moving actions and will require 18 hours of maintenance on the leg to get back to normal.

*Damage to Prosthetic Limbs:* All limbs have a base Protection of 3. Any shot that penetrates that base value causes damage to the limb's Structure. Arms have 6 Structure, while legs have 9 Structure. These are not equivalent to vehicle or starship Structure points.

## **SUBDERMAL IMPLANTS**

Subdermal Implants are a special case and are completely legal practically everywhere. These implants do not go as far as full cybernetic implants. They consist of several types of equipment that are implanted in the body but do not require mind-machine interfaces. Their control is more basic, typically by wiring the controls into the hands and displays to the optic nerve. To activate the devices usually requires a set of hand motions that are unlikely to be performed by accident. After that, the motions of the fingers control the equipment as if it were being held. This interface technology is called 'virtual keyboard/keypad'.

*RFID Chip:* On the Core worlds, many opt to have RFID chips installed, which provide biometric access for their homes, cars and bank accounts. That the chips can also be used to track them does not bother most citizens of the Core, as they see this as another safeguard of their security. RFID chips are implanted with a large hypodermic and take mere moments. In Law Level 8+ societies, this is extremely common.

*Price:* Lv50

*Subdermawatch:* The Subdermawatch is a basic multifunction digital watch implanted just under the skin of the arm. Powered by body heat, it is widely available and widely used. The display is visible just under the skin at the wrist.

*Price:* Lv120

*Subdermatalink:* The simplest of the true subdermals, the subdermatalink consists of a small 15 kilometre range radio implanted in the skull behind the ear, with a microphone placed alongside the larynx. It is not necessary to talk out loud to use the system - sub-vocalising is sufficient. For an additional cost, a link phone can be installed that can make use of the phone networks through the Core and the more developed colony worlds. Numbers can be dialled via the microphone and built-in speech recognition or a virtual keypad can be installed that works through the fingers of the left or right hand. This is similar to the keypads of the subdermacalc and subdermacomp and if either of those devices are implanted, then the subdermatalink can make use of the keyboards

*Price:* Lv400

*Link Option:* + Lv20

*Virtual Keypad:* The simplest of the three styles of virtual input, the keypad can simulate up to about the size and complexity of a multi-function scientific calculator. This option is included with the subdermacalc.

*Price:* Lv200

*Virtual Keyboard:* The most complex of the three virtual interface options, the keyboard is as complex as a full-size computer keyboard. Chording versions are popular, with one key assigned to each finger and input accomplished by key combinations. This option is included with the subdermacomp.

*Price:* Lv220

*Virtual Pointer:* The virtual pointer has to be used in conjunction with the virtual display and either the virtual keypad or virtual keyboard. Essentially, it tracks eye movements and a mental keyboard command will select the object highlighted by the eye movement.

*Price:* Lv180

*Virtual Display:* There are two classes of virtual display. The low-res model is used for subdermacalcs and subdermacomps, as they do not usually require better than a 16-million-colour display. A high-resolution option is available, used by some subdermacomps and external systems. This display provides better-than-photo-realistic colours and has been known to lead to some problems adjusting to the 'regular' palette of colours in the real world. Both of these implant displays actually tap into the optic nerve of one or both eyes, superimposing the generated image over the real-world image.

*Price Low-Res:* Lv150

*Price High-Res:* Lv250

*Subdermacalc:* The subdermacalc is a multi-function calculator/chronometer/compass installed at a suitable point in the user's limb and powered by the body's own heat. It is controlled by a virtual keypad and is linked to the optic nerve via a virtual display. It grants a +1 bonus to any skill requiring calculations and provides the Natural Compass Feat if the user does not already have it. Using the subdermacalc does not require an additional action.

*Price:* Lv750

*Subdermacomp:* The subdermacomp is a much larger unit than the subdermacalc and is similar in performance to a portacomp. The virtual keyboard can be configured for a number of purposes, like the keyboard of the portacomp. The subdermacomp cannot use normal plug-in program chips but it does include a special reader that can interface with the subdermacomp through an induction link, allowing programs to be downloaded to the computer rather than slotted in. This takes about 1–2 minutes per program. Like the subdermacalc, the subdermacomp uses a link to the optic nerve to provide its display. It provides the benefits of the subdermacalc, plus allowing the user to access any database or program on the computer. If the user has a subdermatalc with link phone access, the subdermacomp can connect to available planetary networks, making their databases and information instantly available. The typical subdermacomp has the following stats:

*Computer Power:* Computer/3

*Price:* Lv2,100

*Growler:* The Growler is a specialised implant used for communication with the Ebers and allows a person to duplicate the low notes used in parts of Eber speech.

*Price:* Lv700

## BRAVE NEW WORLDS

A recent trend in the Core has been Augmented Reality, where external head, body and drone-mounted cameras feed the wearer's surroundings into a subdermacomp and the comp overlays a modified image of the world. This can range from editing out ads and billboards to living inside an almost wholly artificial world. These artifices can be shared and experienced by many people and sees people living out their lives while at the same time playing a vast and very complex, game. Typically the system requires a subdermatalc, subdermacomp, high-resolution virtual display and virtual keyboard. Software costs range from Lv100 to over Lv5,000, depending on complexity.

## DNA MODIFICATION

One of the great breakthroughs of 22<sup>nd</sup> Century medical technology was the development of DNA Modification (DNAM) technology. Originally created as a means of curing genetic disorders, DNAMs use tailored retroviruses used to rewrite the genetic code of a mature individual. These changes are permanent and are passed along to successive generations. In the 150 years since they were first developed, they have helped to all but eliminate genetic disorders on the Core worlds. In 2192, a joint American-Canadian team developed the most famous of the DNAMs, the so-called King DNAM, which opened up the hostile world of King to settlement and exploitation.

There are, of course, persistent rumours of DNAM technology being misused, of governments and megacorporations, not to mention ProVolution, creating super-soldiers or super-geniuses. There has been no evidence of this to date, however. Each of the DNAMs mentioned here required upwards of 20 years of development time, something that few megacorporations, governments or terrorist organisations can commit to. These rewrites were largely the work of extra-governmental foundations, in particular the Royal Society, the Life Foundation and the Alberta Farmer's Cooperative.

There are issues in breeding between people who have received DNA modifications. Major modifications are only interfertile with someone who has received the same modification. They can also breed with unmodified humans but only with genetic intervention. They cannot breed with any recipient of a Minor modification without extensive and expensive, genetic correction and cannot interbreed with other Major modification recipients at all. Technically, a person who has undergone a Major DNA modification is no longer human but a different species.

Someone who has undergone a Minor DNA modification can freely interbreed with unmodified humans or with others who have undergone the some DNA modification as them. They can only breed with different DNA modification recipients with significant genetic intervention.

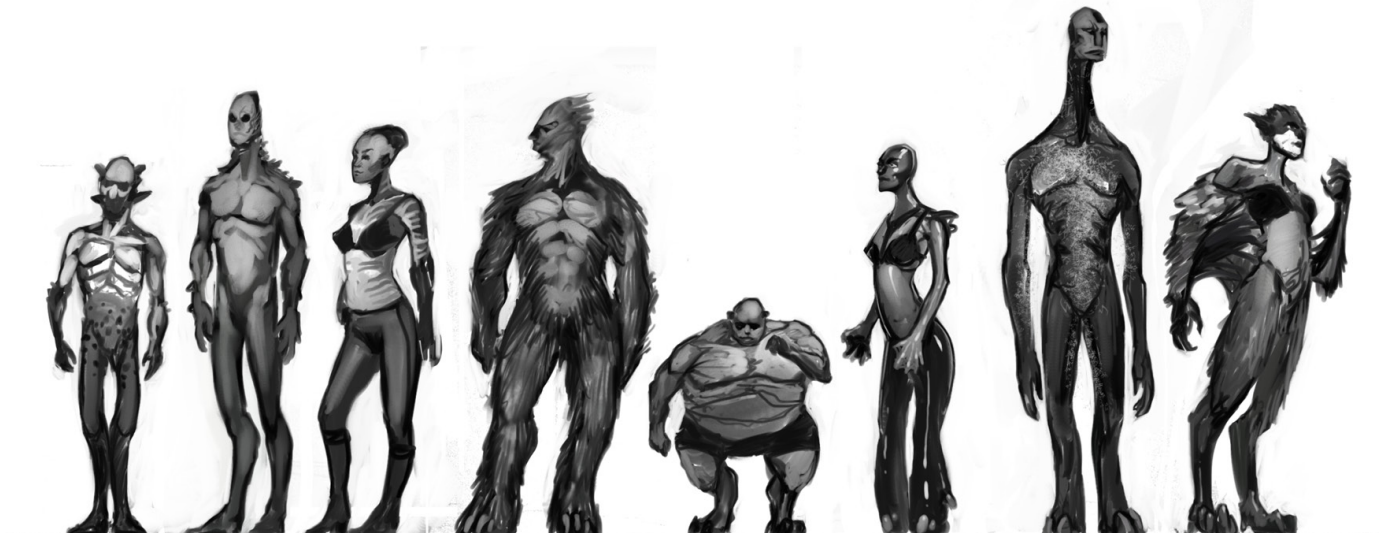

## TRANSHUMANISTS

There is a small but vocal, movement in *2300AD* called transhumanists. The basic tenet of transhumanism is that mankind has developed the tools to improve far beyond the minor tweaks done in the name of eliminating congenital diseases. Super-intelligence, immortality and perfect health are some of the benefits touted by the transhumanists. They feel that DNAM technology has the potential to advance humanity to something approaching godhood and the transhumanists vigorously protest the research moratorium. The opposition to the transhumanists simply has to point at the Pentapods to show where that approach can lead.

DNA modifications can be reversed but the same risks apply as for multiple DNA modifications.

## Gene Riots

In the late 2270's, continued human contact with the Pentapods led to a disturbing conclusion. The human science of DNA modification, which opened up so many worlds to human expansion, was a significant step on the road to whatever it was that the Pentapods have become. People looked at the Pentapods, where their biotechnology has made them virtually indistinguishable from their machines and realised that they were in danger of heading down the same road. This led to increasing protests and riots, until the late 2280s, when most major nations imposed a moratorium on further research into human DNA modification.

*Game notes:* All DNAM treatments are listed with a type, cost and rejection save. Type refers to the severity of the modification. Minor modifications are outpatient treatments, with patient held for an hour or two after treatment to ensure that his body has accepted the procedure. The modification is typically complete within a month, with relatively minor side-effects, such as minor pains, itching and temporary loss of some sensory functions. Patients often choose to be sedated for the duration of the process. Major modifications, on the other hand, significantly rework a sizable portion of the patient's body and usually require the patient to be sedated for up to three months.

Cost simply refers to the cost of the treatment itself and, in the case of major modifications, does not include the cost of the hospital stay. As these modifications are usually performed on colonists, the sponsoring government typically picks up the bill.

If the DNA modification is rejected, it can simply be attempted again. If it is rejected a second time, however, it cannot be retried. If it is retried a third time, the patient will likely get very sick, even if they make the rejection save and will suffer 1d6 Endurance damage. If they fail the rejection check the result is often death due to massive shock and rapidly metastasising cancers and teratomas, for 2d6+1 Endurance damage

*Multiple DNA modifications:* While it is possible to 'stack' DNA modifications, it is not a good idea. The rejection save on the second modification suffers a -2 DM if a Minor Modification and a -4 DM if a Major modification. There is an additional -2 DM to all rejection checks if the current modification is Major. Trying to implant a third modification will almost always fail, as there is additional -4 DM to all check, on top of the penalties for the second check. Even on a successful check 1d6 teratomas will erupt and the recipient will develop Mania on a roll of 1-2 on 1d6 and may develop Annoying Habits on a roll of 1-3 on a 1d6.

*Teratomas:* Teratomas are a type of tumour that contains anomalous tissue, like teeth, finger nails and sometimes even whole structures, like fingers and eyeballs. If teratomas are not removed surgically, then there is a chance (1 in 1d6) that they will develop the Ugly disadvantage as a teratoma erupts in a visible location. Teratomas also reduce Endurance by one point until they are removed.

## KING MASSIVE WORLDER MODIFICATION

The first and most-widely known, of the DNAM therapies, the King rewrite is also the most extensive. The primary change is a rebuild of the host's muscular and skeletal system, greatly increasing the strength and density of both. This tends to alter the subject's height as well, resulting in a more compact but no less massive, individual. Additional changes are made to the host's

cardiovascular system, strengthening the heart and altering the circulatory system to ensure efficient blood flow at all times. The lungs are also altered, allowing them to function properly in King's much denser atmosphere.

Another aspect of the King modification is the addition of an environmental symbiote, called the AFS (Atmosphere Filtration Symbiote), a cluster of micro-organisms that, in this case, live in the subject's lungs and filter the sulphur out of King's air. These symbiotes require the sulphur in the atmosphere in order to live and if someone leaves King for any length of time, the symbiotes will die requiring the person to be reinfected with them upon return.

Less well-known and little-publicised, are the side-effects of the King modifications. The supercharged cardiovascular system, coupled with King's extreme gravity, sees few colonists living past their 50<sup>th</sup> year. Their hearts and bodies just wear out. The DNAMs did not provide any sort of additional clotting mechanism, so any lacerations or penetrating wounds tend to be extremely serious, as the powerful cardiovascular system will send blood jetting out of any serious wound.

*Special Qualities:* All characters who receive the King modification and pass the required Endurance Check, receive the following changes. They receive all heavy gravity modifications, plus an additional (1d6–3) to Strength and Endurance and a penalty of (1d6–4) to Dexterity, with a minimum bonus (or penalty) of one in all cases.

Any damage causes an extra point per 1d6 of damage that penetrates armour. So a 3d6 pistol shot would cause 3d6+3 damage.

Characters from King are Slow and have Minor Atmospheric Requirements (in any atmosphere type less than Dense (1.25 atm), the character must wear a respirator mask).

Further on a roll of 1 on 1d6, the character is inflicted with Chronic Pain. In normal density atmospheres, they are Sensory Impaired (Hearing). To an outside observer, many (roll 1 on 1d6) of King's residents are Ugly due to the severe changes. Note that the penalties from the Ugly Trait do not apply to interactions with other King citizens.

*Type:* Major

*Price:* Free if sponsored, Lv95,500 otherwise. The AFS is Lv100 per treatment.

*Rejection Check:* Difficult Endurance

## **MICRO-G SPACE ADAPTATION MODIFICATION**

Although the King modification is the most noteworthy of the DNAMs, the Micro-G modification is the most common, in particular the environmental symbiote. Anyone who travels off-world for any period of time uses the symbiote and many opt for the full modification. Like all other DNA modifications, this is subject to the rules for having more than one modification.

Like many of the DNAMs, it actually consists of the DNA modification itself, which acts to prevent muscle decay and an environmental symbiote, in this case a micro-organism that fixes calcium out of the bloodstream and back into the bone structure. This symbiote usually needs to be destroyed once the recipient is back in a normal-gravity environment, as some have been known to go awry and keep fixing additional calcium even though the body no longer needs it. This can result in bone spurs and other ailments, up to and including kidney failure. The symbiote thus needs to be renewed whenever the host goes back to a zero-gravity environment.

*Special Qualities:* Acts to reduce difficulty of the Endurance checks needed to avoid muscle and bone loss on long space voyages, with a +6 DM. Use of the environmental symbiote alone grants a +2 DM to avoid problems on long space voyages. Also limits the effects of prolonged micro-gravity exposure. See the *Space Travel* Chapter for more information. A character with the Micro-gravity DNA modification who hails from micro-gravity environment can use the Low-G line on the Homeworld Gravity effect table (Page 89) for purposes of Characteristic reduction only.

*Type:* Minor

*Price:* Initial Treatment: Lv6,000 Subsequent Treatments (Environmental Symbiote) Lv250. Environmental Symbiote alone is Lv600 for the first application. Lv250 thereafter.

*Rejection Save:* Routine Endurance check. No check required for the symbiote.

## **THINAIR**

The Thinair modification is aimed at worlds like Crater, where the surface atmospheric pressure is thick enough to breathe but thin enough to cause a great deal of discomfort. The Thinair modification greatly increases the concentration of blood vessels along the alveoli inside the lungs. This modification acts to increase the amount of oxygen the lungs can draw out of the surrounding air. The downsides of this modification are two-fold. First, normal air feels thick and heavy to breathe, so the increased oxygen can possibly cause the subject to behave erratically. This can be overcome with a special filter mask, which draws out a portion of the atmospheric oxygen. The second drawback is the increased concentration of blood vessels in the upper torso, which can increase the severity of any chest wound. Most consider these drawbacks to be acceptable.

*Special Qualities:* Allows a character to breathe in Thin (<0.60 atm) and Very Thin atmosphere (<0.30 atm) without a compressor mask. In addition, any wound causes an extra point of Endurance damage. Attempting to breathe thicker air without a filter mask will result in oxygen intoxication. This inflicts a –1 DM to all action in standard atmosphere and a –2 DM in a Dense atmosphere. This is a Minor Atmospheric Requirement Trait

*Type:* Minor

*Price:* Lv3,000

*Rejection Save:* Difficult Endurance

### **Rapid-Response Modification**

Rapid-response was coded in reaction to frontier worlds where a significant threat exists that can be moderated through increased reaction times. The Demons of Cold Mountain were one impetus, while the dragon-bats and other predatory fauna of Beowulf were another. The Rapid-Response is added to the typical 'Colonist' package and includes those modifications.

*Special Qualities:* Gives the character the Fast/1 and Peripheral Vision qualities, along with the Colonist Standard package and also causes the Manic flaw on a roll of 1 on 1d6.

*Type:* Minor

*Price:* Lv11,000

*Rejection Save:* Routine Endurance

### **Colonist STANDARD Package**

In recognition of how frontier life offers challenges, outside the realm of Core world experience, colonists typically receive something similar to this standard package. This package is tailored to each world to address the Planetary Adaptation Syndrome symptoms for that world.

*Special Qualities:* Gives the character the Tough/I and Acute Senses (Smell) advantages.

*Type:* Minor

*Price:* Lv7,000

*Rejection Save:* Average Endurance

### **DRY WORLD ADAPTION**

A few colony worlds are so dry that they offer significant difficulties to the settlers. The Dry World modification is added to the Colonist Core Package to alleviate these difficulties.

*Special Qualities:* Character needs no additional water aside from what they get from food. Urine is crystallised, with water retained. They do not cry or sweat. In very hot conditions, they require some sort of cooling vest or suit. Otherwise, they will take damage, at the rate of 1d6/hour if the external temperature is +30 C and 2d6/hour if the external temperature is +50 or higher.

*Type:* Minor

*Price:* Lv12,000

*Rejection Save:* Average Endurance

### **Cold Weather Adaption**

Some frontier worlds are useful but the average temperature is too cold for comfortable or profitable, habitation. The cold weather modification helps adjust that. An extra layer of fat is added, metabolism is accelerated to produce more heat and a second eyelid is added to reduce glare blindness.

*Special Qualities:* Gains the Disease Resistant quality, shifts the damage effect from cold up one step.  $-50^{\circ}\text{C}$  causes 1d6 per hour, while  $-25^{\circ}\text{C}$  causes no damage.  $-75^{\circ}\text{C}$  would cause 2d6 per hour. This modification does not really help with critically-low temperatures. At the same time, the character will take damage from high temperatures in a similar fashion to the Dry World Adaption.

*Type:* Minor

*Price:* Lv12,000

*Rejection Save:* Routine Endurance

### **Hot Weather Adaption**

In contrast, some worlds are too warm for human comfort. The hot weather adaption increases height, darkens the skin and includes some water-saving measures. It also includes the second eyelid, which provides what amounts to a pair of sunglasses.

*Special Qualities:* Changes the damage caused by high environmental temperatures. At  $50^{\circ}\text{C}$ , the character takes no damage. At  $75^{\circ}\text{C}$ , the character takes 1d6 damage per hour. Character also needs very little water, about 500 millilitre per day. On a roll of 1 on 1d6, the character will suffer from the 'Skinny' disadvantage.

Hot Weather adapted characters start taking damage from the cold at  $-15^{\circ}\text{C}$ , for 1d6/hour and 2d6/hour at  $-30^{\circ}\text{C}$ .

*Type:* Minor

*Price:* Lv14,000

*Rejection Save:* Difficult Endurance

### **Kanata Package**

Kanata orbits a flare star and so runs a higher risk of radiation in-fall than most colony worlds. The Kanata package adds an experimental radiation resistance to the core colonist package.

*Special Qualities:* Gives the character the ability to absorb up to 150 rads without incurring damage. This has the effect of shifting the damage on the radiation exposure table (*Traveller Core Book*, page 142) 'up' two categories. This is in addition to the Colonist Standard Package. On a roll of 1 on 1d6, the character also suffers from Chronic Pain (migraines and joint pains). After any radiation event, however, there is a chance (1-2 on a 1d6) that the character will develop teratomas and other non-malignant tumours that need to be removed.

*Type:* Minor

*Price:* Lv12,000

*Rejection Save:* Average Endurance

## **Merman Adaptation**

One of the most severe adaptations available, the merman is common in deep-water cities on earth, along with some frontier worlds. This modification is not an update to the Colonist Core modification and does not include those changes. Mermen on earth face significant bias outside of the underwater cities, although this is one of the only modifications permitted on the human homeworld.

The merman creates a being capable of living comfortably underwater, yet able to interact on land as well.

*Special Qualities:* Provides Acute Senses (Hearing), Gifted Metabolism, Tough/2, along with the same resistance to cold as the Cold Weather Adaptation and Amphibious/3. They can breathe indefinitely underwater if the water is artificially oxygenated ('fizzy water').

At the same time, these modifications also inflict the Annoying Traits and Ugly disadvantage, with a roll of 1–2 on 1d6 also making them Fat, a roll of 1 on 1d6 giving them a Phobia (acrophobia) and a last roll of 1 on 1d6 giving them Chronic Pain.

*Type:* Major

*Price:* Lv25,000

*Rejection Save:* Average Endurance

*Special Qualities:* Adds Sexy quality, also causes the Annoying Traits flaw on a roll of 1 on 1d6. Changes gender, over the course of three months.

*Type:* Major

*Price:* Lv55,000

*Rejection Save:* Difficult Endurance

## **RETROGRADE**

Strictly speaking, DNA modifications cannot be reversed. At best, a second DNA modification can be applied, with all the inherent risks, to bring a person back to baseline human. A retrograde DNA modifier will remove all existing DNA modifiers, with a further –2 DM on the Endurance Check for each additional DNAM after the first.

*Special Qualities:* Recipient loses all stat modifiers and advantages gained from the DNA modification. They also lose all physical complications but retain any psychological disadvantages that the DNA modification may have brought on.

*Type:* Minor

*Price:* Lv20,000

*Rejection Save:* Difficult Endurance

# **OTHER DNA MODIFICATIONS**

## **Gender Reassignment**

DNA modification for gender reassignment was one of the earlier DNA modifications produced and is one of the few available in the Core. For some of the elite, it has become a bit of a fad, called 'gender-hopping'.



# SCIENCE AND TECHNOLOGY

One of the things most noticeable about the technology of 2300AD is that, in comparison to some of the wild-eyed predictions of futurists before Twilight, technology is not really that advanced in comparison to the early 21<sup>st</sup> Century. Space flight is the most notable exception but beyond that the technology is perhaps 20–40 years more advanced than it was at the time of Twilight, over 300 years ago. Several factors contributed to this lack of advancement, the most important of which was the time required to rebuild. Also, much of the technical innovation of the past 300 years went into space travel, in particular the Jerome-effect stutterwarp, along with the challenges involved in exploiting and colonising alien worlds.

In many fields, however, technology has reached a plateau in the years since Twilight, having attained their theoretical limits. Computers in particular have largely reached their technological limits, at least in terms of hardware. The diamond-film computers of 2300AD are not unimaginable by the standards used even before Twilight.

The breakthrough technologies that were allegedly going to change everything, namely nanotechnology and artificial intelligence, are largely dead-ends. Nanotechnology is useful in some industrial processes, especially in materials production but has not proven as useful in other fields. True nano-scale robots never came to pass, though nano-scale components are used in some micro-robots, which are mostly used in medical applications. Artificial intelligence was a field that once held promise but any successful designs degenerated into psychosis within a couple of months of 'waking up'. The problem appears to be related to the complexity required for AI software and the field was largely abandoned by the end of the 22<sup>nd</sup> Century.

## THE BIOLOGICAL SCIENCES

Modern biological science has made great advances in genetic engineering, medical treatment and life prolongation. The main limitation has been ethics rather than capability.

### **Genetic Engineering**

The basic genetic structure of many organisms has been tailored to produce specific results. The major emphasis has been in crop management; modern crops are true-breeding, self-fertilising (nitrogenfixing), highyield plants, well adapted to specific climates and soils. Special use plants are employed for environmental cleanup because they thrive on specific pollutants or

contaminants. Modern waste recycling depends largely on these genetically engineered plants and microbes. Some domestic animals have undergone genetic engineering for colonial use but many colonies elect to make use of local animals when possible, rather than bringing Terran ones along with them.

Genetic engineering companies enjoyed a period of tremendous growth on Earth between 2050 and 2200 but recent growth in the field has been extrasolar. Each new world explored and settled by man requires food crops adapted to specific local conditions. Human adaption on many worlds required genetic intervention as well. Mankind evolved under a very specific set of environmental conditions and to remain healthy on these alien worlds required more than sheer determination. These genetic adaptations are referred to as DNA Modifications (DNAMs).

The most severe of these DNAMs was to the colonists of King. So radical are these modifications that many in the Core no longer consider the residents of that heavy gravity world to be human. People living in very low and micro-gravity conditions have also received DNA modification treatments to slow muscle and bone loss. Due to a swing in public opinion, however, there has been a moratorium on further development of DNA modifications for humans, although research continues into animal modification.

### **TRANSHUMANISM**

Transhumanism is 'the philosophy that we can and should develop to higher levels, physically, mentally and socially, using rational methods,' (Dr. Anders Sandberg, c.1995). In a sense, 2300AD certainly has a transhumanist component, given the advanced state of medical technology and genetic engineering. However, the society of 2300AD has stopped short of true transhumanism, being content to merely eliminate disease and engineer colonists for alien worlds.

Medicine has used genetic engineering to eliminate most inherited diseases and to allow parental selection of characteristics such as gender, eye colour and hair colour. There are strict controls on this sort of selection, however, especially gender selection. Selection for aptitudes and intelligence has been less successful and often results in subjects with behavioural disorders. Current research has focused on remedies for genetic disorders and long-term environmental diseases, rather than actual 'improvement'. The patient is infected with tailored viruses, which then replace his inferior or radiation damaged genetic patterns

with new ones. Genetic engineering also allows replacement organs to be forcegrown from a patient's own tissues, through cellular reversion and stem cell programming. This same technology is used in so-called 'carniculture', where meat can be grown as cultures in a factory setting. This is an energy-intensive process, however and really only suitable for small outposts and large ships.

Pentapod skill in genetic engineering is unparalleled, yet they seem to lack a certain creativity with their constructs. This may be simply a perception of the human observer, as the Pentapods are unfathomable as to their reactions and motivations. Pentapod constructs enjoy a great deal of success in the markets of the French Arm, less so on the other Arms. They have become a new craze on Tirane, where they enjoy very good sales. Earth, however, continues to ban any object of Pentapod manufacture, fearing biological contamination.

The introduction of the Pentapod exo-wombs has resulted in high-risk pregnancies being able to be brought to term in an external host, a technology being looked at with a great deal of interest by many, in particular the residents and authorities of the colony world of King. The long-term psychological impacts of this technology are unknown and Human medical authorities are proceeding very slowly.

### **Medicine**

The major diseases of Earth are environmentally induced: UV damage, radiation and tumours/cancer. Bodies deteriorate from ageing beyond their basic life span. On colony worlds, diseases are caused by local bacterial/viral infections, variants of known diseases and unexpected environmental effects. In space there is heart and muscle degeneration and bone decalcification, along with increased radiation exposure.

Along with genetic screening and genetic engineering, the greatest advance in emergency medicine has been the autodoc – computerised automated medical treatment. Automated tests determine precise results to a battery of standardised tests, while expert systems analyse the results and produce high reliability diagnoses. Chemical and pharmaceutical treatments can be administered automatically and without attendance, supplemented by injected microbots. Life support is also an automatic function. The autodoc can handle almost all non-surgical treatments and most surgical ones (including setting broken bones, removing dead tissue and most types of internal repair). A skilled operator can manage resuscitation and almost all major treatments with an autodoc. Many colonial hospitals consist of only a handful of doctors, nurses and attendants for a small army of autodocs. Along with the new generation of metabolic drugs, the autodoc can speed healing rates by a factor of 10 or more. The universe of 2300AD is considered to be TL 14 in medical procedures.

A recent advance in medicine has been the anagathic regimena series of treatments that effectively ward off aging. Announced and approved in 2264 after decades of testing, the anagathic regimen remains an expensive but effective treatment available

only to the rich. Without the anagathic regimen, normal life span (excluding violent or accidental death) is about 100–120years. The anagathic regimen is expected to more than double that, along with extending one's youthful years by nearly triple the normal time. However, it has not been in use long enough to determine the complete extent of its life prolongation abilities, although 36 years worth of sales have yielded promising results.

## **COMPUTERS AND INFORMATION SECURITY**

Computers are a critical component of the lives of most people in the world of 2300AD. This is particularly true in the worlds of the Core but computers are commonplace in most colonies, save for the most primitive.

Computing equipment is so commonplace as to be hardly noticeable throughout the developed nations of the Core and beyond. In most nations, the information processing charges are billed monthly, just like the power and 3V bills. Computers are extremely easy to use, sporting voice recognition, plain language instructions or talking keyboard input. Computers normally present information using flat screens but they can create voice or holographic presentations if so equipped. Computer hardware is a mature technology and there have been few breakthroughs in size or performance in the past 50 years. Most advancements in capabilities now come in terms of software development. Direct neural input, the so-called man-machine interface, is a new technology, which holds some promise at extending human capabilities.

### **COMPUTER PROGRAMMING**

Low-level computer programming is an automated process. Most programs can be produced just by describing the input, the processing and the results and then checking the computer's sample outputs. Programs created this way are somewhat slower and consume much more in the way of system resources, than professionally-designed programs. Computers are extremely fast and accurate. Expert systems are extensively used and computers have replaced humans in many roles, for example, in sales or reservation clerk situations.

### **THE LINK NETWORK**

Twilight exposed weaknesses in the design of the Internet. Although created to be self-repairing and redundant, the loss of a few key sites crippled the network. Along with that, the localisation of critical data meant that the loss of a physical location caused the loss of that data.

When the data and voice networks started to rebuild in the 2080's, they were piggybacked on the same lengths of fibre-optic cable to save expense. As the network improved, wireless communications for voice and data became the norm, with local repeaters tapping into the fibre-optic backbone. The modern link

network is massively decentralised, which ensures that the loss of key nodes will not cripple the network.

The Link network makes use of the massive storage potential of every computer to ensure redundancy. All data for a system is stored locally but a backup exists on the network across multiple machines. Each backup machine only has a portion of this data, which is useless without the rest of the data and each portion is tagged with a unique code for the owner of the data. In addition, this data is highly encrypted, making it virtually impossible for anyone but the government to crack. All computers connected to the Link Network sacrifice about 10% of their internal storage capacity to the network and in return have their data backed-up on a constant basis.

## COMPUTER VIRUSES

The massively-connected nature of the Link network does mean that it is more vulnerable to certain types of malicious programming, including viruses. However, most computers are designed in such a way that they are not nearly as vulnerable as the computers of the pre-Twilight Era. Viruses and hacking do still occur, however.

## USER INTERFACES

The interface is how a person interacts with a computer. This covers hardware, how they interface and software, how data is displayed and organised. Most computers accept both voice and touch-screen input, along with a variety of keyboards and pointing devices, from the humble mouse to full 3D virtual systems. Some go to the trouble of having a virtual keyboard implanted, with a transmitter designed to allow them to connect to a computer. This can be coupled with an implanted display, giving the user completely private access to their system.

The software side of the user interface is based on the standard developed by France's École Polytechnique back in the 2250's, which mandates that as much information as possible and practical, be expressed in graphical and preferably ideographical, format. Programs thus have stylised representations on the computer, with different programs having different representations depending on the whim of both the programmer and the user.

## MECHANICAL TELEPATHY

Also known as cortex-hacking or even ghost-hacking, this technology couples a sub-quantum induction device (SQuID) to a human with an increased sensitivity to electromagnetic fields. This combination allows a target brain to be scanned and read and is often used in court cases. Since the electrical impulses can be recorded and reread by a second sensitive, the evidence is considered to be verifiable by most courts. Interestingly, Texas, Azania and Iran do not accept information from cortex-hacking in a court of law. However, they do permit its use as an information-gathering device when there is a potential threat to the life of an individual.

## ROBOTS AND DRONES

Robots are very common in the society of 2300AD. Robotic systems can be found almost anywhere, from the automated surveillance drones that wander the streets of the Core cities, to the mining equipment used on remote colonies. Robots in 2300AD are defined as machines that can follow a set of guidelines without human supervision or intervention. These machines have a limited learning capacity, allowing them to remember solutions and implement them in similar situations. They are not capable of thinking, however.

Drones are simply remote-controlled vehicles, requiring almost constant operation and supervision. Many robots also have a remote-control facility, however, blurring the lines. Typically, a robot can be remote-operated but a drone has no self-guiding capability and is thus considerably cheaper.

Swarms are small robots, about bee-sized, operating in large groups. The most common use is in surveillance and rescue work, where a swarm can fly or crawl in and present a high-resolution composite image very quickly.

## MICROBOTS

Microbots are a different class of robot or more properly, drone. Microbots range in size from just a little larger than red blood cells up to the size of a dust mite. They are operated and powered remotely and can venture no further than two metres from the controller/power broadcaster. Most microbots are used in medical applications, stitching someone up from the inside, cleaning arteries or scrubbing poisons out of a system. Others are used in security and surveillance but the range restriction severely hampers them. They are sometimes used to thoroughly search rooms, particularly in police crime-scene investigation.

## MATERIALS SCIENCE

Materials science in the 23<sup>rd</sup> Century has been extremely successful at producing sophisticated synthetic materials for fabrication and construction. These synthetic materials are largely ceramic-metal or ceramic-polymer composites, with high strength and low weight. The production of these exotic materials is made practical with nanotech fabricating. Although these techniques can only churn out large sheets of the material from their cooling baths. New techniques have also been developed for refining metals purer and cheaper than ever before. Recent breakthroughs in electrically and magnetically stabilised metals have produced metal fibre/carbon buckytube synthetic matrices that allow beanstalk cables, which can connect a world surface to orbit. Beanstalks have been built on two worlds: Beta Canum Venaticorum (at Premiere) and Earth (at Libreville in Africa). While metals are still used for fabrications in space and on Frontier worlds (where metal ores are plentiful and cheap), synthetics can now do most jobs more efficiently and are used almost exclusively in vehicle construction, power plant components and all machinery requiring high strength and low weight. On Earth, metal is seldom used except in a few electrical components and where its high density is an asset, such as radiation shielding.

# TRANSPORTATION

The near exhaustion of fossil fuels prompted the development of alternatives. Fusion power is efficient and cheap but practical only in large installations. On Earth, it has been replaced by solar power satellites, which beam their energy down to the ground.

Vehicles require a portable energy system because they cannot hook into the electric power grid. After experimentation with alcohol fuels, Earth made the transition to hydrogen in the 22nd Century and hydrogen fuel stations are as common as gasoline stations were in the 20th Century. Most hydrogenpowered vehicles utilise hydrogen fuel cells, although a few actually burn it to provide mechanical power. Large vehicles or those requiring very high energy levels, can benefit from the scale efficiencies of magnetohydrodynamic (MHD) turbines. Battery technology has likewise improved to the point that electric cars are common and costeffective. Approximately 60 percent of the wheeled and tracked ground vehicles on Earth and Tirane are battery-powered. Nearly all major roads and highways on Earth are designed for automated vehicles only, with the vehicles being controlled by a combination of on-board and remote computers and sensors called TrafCon (Traffic Control). Tirane uses the system only for major thoroughfares, while beyond the Core, these automated roadway systems are extremely rare.

Vehicles and the attendant TrafCon system are effective for relatively short-range travel but for longer distances people and cargo are, for the most part, moved by high-speed maglev trains. These operate in partial-vacuum underground tunnels, often just called 'tubes'. Major tube lines travel between large terminals centred in metropolitan areas. Smaller feeder and commuter lines radiate from these central terminals. Generally well suited to meeting peak commuter loads (there are always exceptions), the 'tube' systems allow metropolitan areas to be very dispersed and it is not uncommon for workers to commute 200 kilometres

to and from work. These local trains can travel at speeds up to 500 kilometres per hour but are usually much slower due to frequent starts and stops.

In the colonies, hydrogen-burning fuel cells predominate as the power plant for most vehicles. Away from the main settlements, transport is typically via hovercraft or ATV. In less-developed colonies, horses and other riding animals are still a key mode of transportation. Most air travel is by tilt-rotor aircraft or the versatile little Magnus-effect airship. Large, expensive jet aircraft are rare on the frontier worlds.

Travel across oceans tends to be by ship, airship or aircraft. Short-range oceanic voyages are often by hovercraft, especially in ferry services. Most passenger and cargo ships are of the SWATH-type; a completely submerged streamlined flotation hull containing the vessel's power plant and fuel bunkers linked by pylons to the upper passenger and cargo decks, which ride considerably above the waterline. This design makes for an extremely efficient and stable ship as there is virtually no surface contact, thus drag is much reduced. The tremendous power needed to lift a large ship onto hydrofoils is also unnecessary. Unlike hydrofoils (which are still used for a variety of high speed naval and pleasure craft), this is a deepwater vessel only.

Airships are somewhat more expensive than surface vessels and largely make up for this by their greater flexibility. Large-capacity airships carry both cargo and passengers across the oceans of the Earth and can land them at a variety of inland destinations. Large airships can carry upwards of 500 tons at high speeds, using hybrid semi-rigid lifting body hulls. Other airships are used as mobile cranes for construction projects, especially in remote areas, while nimble little Magnus blimps carry passengers and cargo, even in urban areas. For passengers and cargo that need to travel quickly, there is always the SOT (Sub-Orbital Transport) service, which can move a passenger from one side of the world to the other in a couple of hours via scramjet.

# EQUIPMENT, WEAPONS AND ARMOUR

This chapter contains details of the personal equipment, weapons and armour found in human hands in the 24th Century.

## EQUIPMENT

The following equipment is generally available on most human worlds (at the Referee's discretion). Tech Level is not really a factor for much of this gear, as it all usually available on any colony world. Typically, costs for these items will be doubled on frontier worlds.

### WILDERNESS SURVIVAL GEAR

Wilderness survival gear includes equipment that is usually used by exploratory teams but this equipment might be stored in a starship's escape pod or used by a military team as well.

*Compact Rations:* Each ration pack is a complete, pre-packaged, fortified meal in its own serving tray. The meal is self-heating (or self-chilling) as required. The chemical heating/cooling process is activated by breaking the seals and takes about 30 seconds. In military parlance, these are known as SSMS (Single-Serving Meals) and are the bane of any soldier's existence (military rations are universally despised).

TL: 8

Mass: 1 kg

Price: Lv15

*Cold Climate Clothing, Advanced:* A lightweight, adjustable body suit with hood, goggles and lower face cover. The suit contains a battery pack and internal heating elements with the ability to maintain a stable temperature down to temperatures of 30 °C. Battery life is about eight hours under the coldest conditions but closer to 36 hours under more typical cool weather conditions. Characters wearing Advanced Cold Weather Gear take no damage under Arctic conditions (-25°C) and only 1d6 per two hours under Martian (-50°C) conditions.

TL: 9

Mass: 2 kg

Price: Lv300 (More expensive versions are available for the fashion conscious.)

*PSuit:* A closefitting flexible pressure suit with bubble helmet and a battery powered life support system, with heating, cooling and air recycling. The life support unit has a duration of eight hours but bottled oxygen can extend this up to 20 hours (maximum battery life). The helmet includes a short-ranged (five kilometre) radio and beacon. Use of the P-suit requires the Vacc Suit skill

TL: 10

Mass: 15 kg

Protection Rating: 6

Dex Penalty: -1

Price: Lv3,000

*Hostile Environment Suit:* A heavy-duty pressure suit designed for use in particularly hostile environments (such as corrosive atmospheres or radiological and toxic environments). The helmet is solid, with audio and visual sensors linked to in-helmet monitors.

The hostile environment suit reduces all radiation exposure by 250. It is good for up to 25 hours in a Corrosive atmosphere and up to eight hours in an Insidious atmosphere. After that it will begin to break down at the rate of one point of armour per hours. Use of the hazard-suit requires the Vacc suit skill.

The suit contains a short-ranged (five kilometre) radio in addition to the built-in sensors.

TL: 11

Mass: 20 kg

Armour Rating: 8

Dex Penalty: -2

Price: Lv6,000

*Personal Life Support System:* The PLSS extends the capabilities of a pressure suit, adding additional power and life support capabilities. A PLSS is good for 24 hours of use and can be extended up to 48 hours by adding additional bottled oxygen. A PLSS can also be equipped with a radiation shield generator, which lowers its endurance to eight hours.

TL: 9

Mass: 12 kg

Price: Lv3,000

*Air/Oxygen Tank:* Self explanatory.

Mass: 1 kg

Endurance: +6 hours per tank

Price: Lv100

*Radiation shield generator* This back-pack mounted power supply feeds an electro-magnetic field that diverts or absorbs incoming charged particles.

TL: 11

Mass: +4 kg

Protection: Reduces exposure by 120 rads/hour

Price: +Lv5,000

**Pressure Tent, Small:** An inflatable hemispherical tent with a radius of two metres. The tent includes a small airlock along with a life support system good for 12 man-days (i.e. 12 men for 1 day or 1 man for 12 days). The airlock can be detached for use on worlds with breathable atmospheres. It is powered by a solar panel built in to the roof but if that is obscured it only has power for 12 hours.

*TL:* 9

*Mass:* 2 kg

*Price:* Lv500

**Pressure Tent, Large:** An inflatable half-cylinder with a width of four metres and a length of 10 metres, the large tent is suitable as an exploration base. The tent includes a small airlock and the life support system is good for 120 man-days. The interior can be sub-divided many different ways. Again, the large tent is powered by roof-top solar cells but it can also be run off a power station or fuel cell. The large p-tent is self-assembling.

*TL:* 11

*Weight:* 30 kg

*Price:* Lv2,000

**Goggles:** Goggles come in two different types, the first being nothing more than an inexpensive piece of protective eyewear and the second being a photosensitive, auto-darkening piece of equipment to protect against steady bright light or sudden flares. The auto-darkening models provide a +1 DM for checks against blindness induced by lasers or flares.

*TL:* 2 (normal goggles) or 8 (photosensitive goggles)

*Weight:* Insignificant

*Price:* Lv5 (normal goggles) or Lv190 (photosensitive)

**Water Purifier:** A battery-operated micro-filter and chemical treatment machine for purifying natural water sources. It can also be used to recycle biological waste water.

*TL:* 10

*Weight:* 5 kg

*Price:* Lv2,100

**Backpack:** A backpack is used to carry equipment (as well as protect it) while keeping hands free. Small items can also be suspended from its frame.

*TL:* 2

*Weight:* 1 kg

*Price:* Lv60

**Flares:** Flares are used to signal at a distance, such as in the marking of temporary landing areas. They typically come six to a set. Flares are automatically seen by anyone with a line of sight to them.

*TL:* 6

*Weight:* 2 kg

*Price:* Lv10

**Respirator:** Often an entire protective suit is unnecessary and unwieldy. In such situations, people commonly use a simple respirator mask to filter the air they breathe. Typically, the filters in such a mask must be changed every 6 to 12 hours, depending

upon the amount of pollutants in the air. A filter mask grants a +1 DM to Endurance checks involving atmospheric taints.

*TL:* 6

*Weight:* 1 kg

*Price:* Lv350

**Replacement Filter:** Self explanatory.

*Weight:* Insignificant

*Price:* Lv15

**Diving Gear:** The term diving gear is used here to describe a flexible, warm, wetsuit with swim fins, goggles and an air tank. It requires the Athletics/Swim skill to use effectively and negates the Swim check penalty for consecutive rounds spent underwater. The gear also adds 25% to a character's underwater speed.

*TL:* 4

*Weight:* 10 kg

*Price:* Lv2,100

**Diving Gear, Advanced:** Advanced Diving gear dispenses with the tank in favour of a gill unit and makes use of more sophisticated materials for the wetsuit and fins as well. The gill has enough power for 12 hours of operation, while the wetsuit and fins allow swimming at up to 50% faster than normal. It requires the Swim skill to use effectively and negates the Swim check penalty for consecutive rounds spent underwater.

*TL:* 10

*Weight:* 6 kg

*Price:* Lv3,600

**Thermal-visual (TV) Camouflage.** TV camouflage consists of two parts: the camouflage smock or blanket, itself and a thermal regulation system that can adjust the heat output to match the surroundings. Typically, it does this by redistributing heat patterns around the material to break up the thermal signature and also by dumping excess heat into the regulator. The chill can of the regulator lasts for up to eight hours before it needs to be replaced.

The camouflage smock or blanket is essentially a tough, flexible sheet of electronic paper, which can change its colours and patterns to match the surrounding terrain without light emissions. This system is only effective at medium to long ranges and only if the user keeps still. It does not work well at all on the move. It adds a +6 DM to all Stealth Skill Checks if the user keeps still; otherwise it only adds a +1

*TL:* 12

*Weight:* 2 kg (+8 kg for the thermal regulator)

*Price:* Lv12,000

## TOOLS

The listing which follows includes the tools commonly available for use in the 24th Century.

**Basic Tool Kit:** Small hand tools suitable for a variety of purposes, including wrenches, pliers, screwdrivers and so forth. This

allows a character to perform Mechanical skill checks with no penalty.

TL: 4

Weight: 5 kg

Price: Lv250

**Power Hand Tools:** A selection of power tools, including a chainsaw, rotary saw and drill, as well as other electrical tools. There must be an electrical power source, such as a generator or battery pack, to operate these tools.

TL: 7

Weight: 35 kg

Price: Lv450

**Vehicle Maintenance Tools:** Specialised tools for repair and maintenance of vehicles. Includes torque wrenches, grease guns, engine calibration tools and other specialised tools. Use of these tools gives a +1 DM to all Mechanical Skill Checks on vehicles and aircraft but not spacecraft.

TL: Special (must be no more than 1 TL below the vehicle being serviced).

Weight: 10 kg

Price: Lv500

**Excavating Tools:** Picks, shovels, mattocks and other such tools.

TL: 1

Weight: 20 kg

Price: Lv300

**Construction Tools:** Hammers, saws, squares, hatchets, chisels and other woodworking tools.

TL: 2

Weight: 30 kg

Price: Lv300

**Electronic Repair Tools:** Specialised tools for work on electronic and photonic equipment. Use of this tool kit allows the Electronic Skill to be used with no equipment penalty.

TL: Special (must be the same TL or no more than 2 TL higher than the equipment being worked on).

Weight: 3 kg

Price: Lv1,000

**Climbing Kit:** A climbing kit includes such tools as pitons, 100 metres of fine rope, small hammers and carabineers. Use of the climbing kit confers a +1 DM to all Athletics\Climbing Skill Checks.

TL: 3

Weight: 12 kg

Price: Lv450

**Autograpnel:** The autograpnel consists of a handheld battery-powered compressor unit that can fire a small grapnel as much as 20 metres into the air and then pull as much as 100 kilograms up the trailing rope. The battery is rechargeable and lasts for 20 uses.

TL: 9

Weight: 7 kg

Price: Lv660

**Locksmith Kit:** A locksmith kit contains tools for opening mechanical locks. On most worlds it is illegal for an individual to possess a locksmith kit without a local licence. The locksmith kit allows a character to use Mechanical to pick mechanical locks. All locks are rated by the Difficulty of picking them. If the locksmith kit is not available, add a DM of -4 to all Lockpicking Skill Checks.

TL: Special (Must be within 2 TL of the lock being worked on.)

Weight: 2 kg

Price: Lv1,350 (Lv4,000 or more on the black market)

License: Lv1,500

**Electronic Security System Kit:** An electronic security system kit is not intended to provide electronic security but to circumvent it. It is usually even more illegal to own than a locksmith kit. The electronic security systems kit allows the use of the Electronics Skill to crack electronic locks. Electronic locks are rated by the Skill Check required to circumvent them and are typically more secure than mechanical locks. If no electronic security systems kit is available, then apply a DM -4 to all attempts to bypass the lock. Subtract the TL of the lock from the security and use this number as a DM in all circumvention attempts.

TL: 9+

Weight: 3 kg

Price: Lv3,000 minimum (Lv10,000 or more on the black market), +1,500 per TL after TL9

License: Lv7,500

## SPECIAL EQUIPMENT

Major expeditions and military teams are often able to acquire equipment that is state-of-the-art and unavailable to the general populace of most worlds. Often, however, this specialised equipment can be found for sale on the Core worlds, at least to those who are able to pay the price.

**Mul-T-Tool:** Many tools throughout history have been designed for one purpose – to fasten things together. Recently, builders of new vehicles have agreed to begin using a uniform set of fasteners in their construction processes. For work on these vehicles, a mechanic need not have several different types of wrenches and screwdrivers; he just needs a Mul-T-Tool. This is a self-powered unit with a flexible head that automatically adjusts to fit the fastener size. Mul-T-Tools come in three gauges for three ranges of fastener sizes. All vehicles constructed at TL 11 or higher are designed for use with the Mul-T-Tool. Light Vehicles only the smallest size, while Heavy Vehicles require all three sizes. Multi-tools grant a +1 DM to all Mechanical Skill Checks for repairs made while using the tool.

TL: 10

Weight: 0.5 kg, 1 kg and 2 kg sizes

Price: Lv300 each

*Spinner:* Utilising some of the same technologies used in construction of the beanstalk, the spinner is capable of creating exceptionally strong carbon monofilament line. The 0.2mm line is capable of supporting up to 1,000 kilograms in a normal gravity. Care has to be taken with the line when it is under tension, as the extremely thin cable can easily slice off fingers or even limbs. The spinner contains material and catalysts in sufficient quantity to produce two kilometres of line and comes equipped with a catalyst capable of cutting the material (which cannot be cut with a steel blade), along with a supply of 20 special pads (which can be fastened to a glove if needed) to handle the cable. If stretched taut, the cable can inflict up to 3d6 damage and ignores non-rigid and inertial armours.

*TL:* 12

*Weight:* 1 kg

*Price:* Lv3,000

*Stik-kit:* A Stik-kit is an adhesive patch that is about the size of a normal human hand. One side of the Stik-kit patch (black with colour-coding) is a ridged, flexible plastic sheet; the other side of the patch is smooth and white. Between these two sides is a chemical interior. By grasping the ridged side of the Stik-kit, the user can flex the patch, which releases the inner chemical onto the white side. The white side then becomes very sticky. Stik-kits will adhere to anything in almost any environment, including vacuum and under water. Application of a small electric charge inactivates the adhesive. A small battery is included in the Stik-kit for this purpose and the user may then discard the patch. A Stik-kit is not reusable.

Stik-kits can be used for anything from patching hulls to mounting wall fixtures, creating ladders, joining items or suffocating creatures. Each Stikkit patch has a colour coded band that indicates its holding strength: red 10 grams orange 100 grams, yellow 1 kilogram, green 10 kilograms, blue 100 kilograms, violet 1 ton, ultraviolet 10 tons.

*TL:* 11

*Weight:* 0.25 kg per patch

*Price:* Red Lv20; orange Lv40; yellow Lv80; green Lv160; blue Lv320; violet Lv640; ultraviolet strength patches are not normally available. But generally are available for Lv1,000 to properly accredited clients.

## SENSORS

Sensors are available for a wide-range of purposes, from simple binoculars to computer-controlled perimeter surveillance systems.

*Binoculars:* Visual binoculars that incorporate thermal imaging for night visibility and limited visibility in fog, gyro-stabilisation for high magnification steadiness and adjustable magnification from 1x through 20x. The binoculars modify a character's Recon Skill check by changing the range increment for the Spot penalty. Multiply the current magnification by three to determine the range increment (i.e. at x10 the new range increment is 30 metres, so the character suffers a -1 Recon Skill Check penalty for every 30 metres).

*Weight:* 1 kg

*Price:* Lv600

*FarSeer:* This binocular-like product magnifies objects and/or allows night vision by internally enhancing the light received. The main lens is composed of oil, electrostatically held and manipulated for focus. The unit is stabilised for low-range viewing or can be mounted on a tripod. The charge used to focus the lens can also give an approximate range value. A backup system, consisting of a pulse laser, gives more accurate readings of any object lined up with cross hairs in front of the lens. The only problems with the system are that the laser is visible to instruments watching for it and the electrostatic lens will not hold focus in a strong outside electrical field, such as a nearby lightning storm. The FarSeer magnifies from 1x to 120x. A FarSeer modify a character's Recon Skill check by changing the range increment for the Spot penalty. Multiply the current magnification by three to determine the range increment (ie at x100 the new range increment is 300 metres, so the character suffers a -1 DM to Recon Skill Checks for every 300 metres).

*TL:* 11

*Weight:* 1 kg

*Price:* Lv1250

*Large Life Form Detector:* This is an IR sensor that works as well on vehicles as life forms. Its short range makes it largely ineffective for military purposes, however. It is designed to be cheap and portable for zoological field teams. It give a +1 DM to Recon and Intelligence rolls made to spot anything warmer than the ambient background temperature.

*TL:* 10

*Weight:* 2 kg

*Range:* Medium

*Price:* Lv300

*Basecamp Security Sensor:* This is a multipurpose active/passive sensor suite designed to provide warning against intruders at remote sites. It must be attached to a vehicle powerplant or other power source in order to function.

*TL:* 11

*Weight:* 50 kg

*Range:* Long vs. Ground Targets, Distant vs. Aircraft)

*Price:* Lv20,000

*Superconducting Electromagnetic Sensor (SCEMS):* The SCEMSs system is capable of detecting any sort of electromagnetic energy, from the firing of a vehicle spark plug to the burst from a gauss weapon. It provides a rough guide to direction and range to the source, along with the source's relative strength. Equipment and weapons can be shielded against SCEMS detection but it is expensive.

*TL:* 11

*Weight:* 5 kg

*Range:* V. Distant

*Price:* Lv35,000



*SCEMS Shielding:* Weapons and equipment can be shielded against SCEMS detection. The cost is Lv5,000, + double the cost of the weapon or device.

## SCIENTIFIC EQUIPMENT

A variety of equipment is generally available to aid scientific teams in their work. The most common pieces are listed here.

*Imagers:* A wide variety of still and video imagers are available to record observations. Imagers in the 24th Century produce two types of images: a nearly grainless BIT (Binary Image Trace) image, which is a totally faithful picture of the object or scene but requires extensive memory or an EFR (Encoded Formula Reduced) image which uses algorithms and templates to analyse the image and translate it into a set of formulae. Images from these cameras have long surpassed film in quality of image, being able to capture more information than the finest films. Images are stored on a small memory chip and can be displayed on virtually any display system or computer. A single chip holds approximately 3,000 EFR images (each BIT image counts as 100 EFR images).

*TL:* 10

*Weight:* 1 kg

*Price:* Lv300 (extra video chip costs Lv5)

*Sampling Kit:* A small kit carried by means of a shoulder strap used to take field samples and conduct quick analysis of any of a variety of substances. Sampling kits are available for soil, minerals, plants and gases (atmosphere). Sampling kits allow the use of the appropriate skill (Biology, Planetology or Chemistry) without incurring an equipment penalty.

*TL:* 10

*Weight:* 4 kg

*Price:* Lv1,200

*Remote Meteorological Station:* A small data collection station for monitoring rainfall, humidity, atmospheric pressure, wind speed and direction and other meteorological and climatological data. These are generally cheap, unmanned sensors that record their data on a memory chip. Each chip can record three years' worth of data, although the station is usually visited more often than that. These are very useful in the early stages of a survey of a habitable world. A radio communicator may be added for remote monitoring if desired at additional cost. For every 10 remote met stations deployed on a planet, add a +1 DM to Planetology skill checks to determine planetary climate (maximum bonus of +4).

*TL:* 9

*Weight:* 5 kg

*Price:* Lv500

*Autoinjector Gun:* Sometimes called a tranq gun, this is a compressed air rifle that fires an autoinjector or radio microtransponder. It is used to subdue or tag animals. The radio microtransponder has a range of five kilometres and can be monitored from a radio direction finder. It broadcasts a simple

electronic noise signal useful for determining direction and range. The associated direction finder weighs three kilograms and costs Lv50.

*TL:* 7

*Weight:* 2 kg Length:

*Range:* Carbine

*RoF:* 1

*Damage:* 2d6 (stun damage only)

*Price:* Lv500

## MEDICAL EQUIPMENT

In high-risk employment, violence and injury are a part of life, if not commonplace. In the 24th Century, high quality medical aid is generally very close at hand.

*Medkit:* A portable first aid kit containing spray on bandages and autoinjectors of antishock, antitoxin, antibiotic, stimulant and anaesthetic. Given medical skill, the Medkit contains everything needed to treat minor injuries and stabilise serious conditions.

*TL:* 10

*Weight:* 1 kg

*Price:* Lv1,500

*Lightweight Autodoc:* Portable and inexpensive, this unit is popular with emergency teams and is often used in large numbers for disaster relief. Use of a portable autodoc boosts all healing rates by four times normal and adds a +1 DM to all Medical Skill checks. In the absence of a qualified human operator, the autodoc can use its stats (page 172).

*TL:* 11

*Weight:* 300 kg

*Med Skill:* 2 Int: 8

*Price:* Lv6,000

*Static Autodoc:* This static autodoc is designed for permanent emplacement in a hospital ward or on a starship. Use of a static autodoc boosts all healing rates by six times normal and adds a +2 DM to all Medical Skill checks. In the absence of a qualified human operator, the autodoc can use its stats (page 172).

*TL:* 12

*Weight:* 1,000 kg

*Med Skill:* 3 Int: 10

*Price:* Lv25,000

## COMMUNICATORS

Communicators allow the transmittal of information over long distances. Civilian ones tend to be lower powered and broadcast in a wider arc than do their military counterparts.

*Link Phone:* A link phone connects to the planetary networks and data services available on the Core worlds and many colony worlds. Link phones sold on Core Worlds include a Panic Button feature, which will summon authorities to the location of the phone. Of course, this requires that the phone be tracked but

most people value the added security. This feature is not available on the frontier, where authorities do not go to any lengths to track their citizens. Link phones also serve as small computers, game-playing devices, cameras, voice recorders and GPS systems. In the Core they are everywhere.

*TL:* 9

*Weight:* 0.2 kg

*Range:* 2 km

*Price:* Lv10, plus Lv3/month voice/video access and Lv4/month for data access.

*Hand Communicator:* A battery powered, handheld radio that broadcasts voice signals at relatively low power.

*TL:* 8

*Weight:* 0.25 kg

*Range:* 20 km

*Price:* Lv90

*Backpack or Vehicle Communicator:* A heavier version of the hand communicator. In a vehicle it is generally linked to a vehicle's power plant.

*TL:* 9

*Weight:* 3 kg + 2 kg battery if not connected to a vehicle

*Range:* 200 km

*Price:* Lv300

*Tight Beam UpLink Communicator:* A tight beam communicator designed to provide secure communication between a ship in orbit and a ground party. The communicator's microprocessor is programmed with the ship's orbit prior to landing and its inertial locator will constantly update its position relative to the ship's position. When activated, it will point its dish antenna toward the location of the ship and establish a tight beam communication link, provided the ship is above the horizon and in effective communication range. In most orbits the ship will be in an acceptable commlink position roughly 20 percent of the time. The higher the orbit of the satellite, the longer the period of possible commlink access but the greater the time between commlink periods. Two uplink communicators can be used for secure ground communication if a communication satellite is overhead and if both communicators are linked to the satellite at the same time.

*TL:* 10

*Weight:* 10 kg

*Range:* Orbital

*Price:* Lv1,500

## SATELLITES

Satellites are generally placed in orbit by ships already in orbit around a world. In the rare cases that they are launched from a colony world, they will typically use inexpensive disposable rockets. Survey and exploratory ships routinely use satellites to augment information gained by ground parties.

Defence satellites are covered in the Spacecraft and Starship section.

*Communication Satellite:* A solar powered orbital receiver and retransmitter of tight beam or broadcast communication. Each provides 20 percent coverage while five satellites evenly spaced in the same orbit will provide 100 percent coverage.

*TL:* 8

*Weight:* 20 kg

*Size:* 10 vol

*Price:* Lv150,000

*Navigation Satellite:* A solar powered orbital broadcast transmitter. Five satellites are required to provide good coverage of a planetary surface. Each satellite continuously broadcasts its identification and current position. A downlink receiver and microprocessor in a vehicle or carried by a person can, by triangulation with the satellites currently transmitting, establish its correct surface location to within half a metre. Access to a navigation satellite network grants a +1 DM to all Navigation Skill Checks.

*TL:* 9

*Weight:* 100 kg

*Price:* Lv300,000 (each)

*DownLink Navigation Receiver:* This is a small hand-held unit that indicates the user's position on a digital map. It uses the navigation satellites to calculate its position and can download map information from available survey satellites or the Link network on more settled worlds. Accurate to within half a metre.

*TL:* 9

*Weight:* 2 kg

*Price:* Lv50

*Surveillance Satellite:* A solar powered, low-orbit satellite designed to detect movement of baseball-sized or larger targets on the surface or in the atmosphere of a world. Each satellite will orbit an earth-sized planet roughly three times a day and will scan the area directly below and 50 kilometres either side of its orbit. Military versions are rumoured to be able to read the fine print on a legal contract.

*TL:* 12

*Weight:* 150 kg

*Size:* 75 vol

*Sensor Range:* Orbital (surface targets count as regular range; airborne targets count as half range).

*Price:* Lv1,500,000

*Survey Satellite:* A solar powered photographic satellite for mapping and collecting meteorological data. It is placed in low orbit to provide surface mapping and data on atmospheric weather conditions. The survey satellite confers a +2 DM to all Planetology Skill checks.

*TL:* 10

*Weight:* 50 kg

*Size:* 25 vol

*Price:* Lv750,000

*Weather Satellite:* A solar powered satellite intended to provide detailed meteorological information for the world below it. Purpose-built for weather monitoring, it is not suitable for surface

mapping, although these satellites have been jury-rigged for such duties on occasion. It usually inhabits a lower, polar orbit, passing over the entire globe in the course of many orbits.

*TL:* 9

*Weight:* 20 kg

*Price:* Lv345,000

## COMPUTERS

Computers make up a part of daily life for citizens of the Core worlds in the 24th Century and they are an essential part of any mission group as well. The two most common encountered configurations are detailed here.

*Portacomp:* The portacomp is a small handheld programmable computer, usually carried in a plastic case on the belt or on a shoulder strap. A wide variety of makes and models are available, of which the following is a representative model. The keyboard is a one-handed five key hemisphere roughly 10 centimetres in diameter, designed to be held in one hand. The monitor is on the back of the hemisphere and is touch sensitive, allowing an expanded range of inputs while programs are running. Voice input and output are also used but the keyboard and monitor are useful for a variety of precision inputs and graphic outputs. A flexible 30x20 centimetre monitor expansion (also touch sensitive) can be carried rolled in a tube in a carrying case. The machine has 1,024 gigabytes of internal memory and is designed to run off of up to five 500 gigabyte memory/program chips. Other styles include tablets with touch and stylus input and wearable computers accessed via voice commands or neural jacks.

*TL:* 12

*Power:* Computer/4

*Weight:* 0.5 kg

*Price:* Lv500

*Flexible Monitor:*

*Weight:* 0.2 kg

*Price:* Lv100

*Military Artillery Computer/Communicator:* The artillery computer is a specialised portacomp that is tied into local navigation satellites for precise positioning. It can be used to call down precise artillery strikes at areas designated on its map board. Use of this function of the computer requires the Recon skill and can be tied into any modern (TL11+) artillery. This computer otherwise has the same stats and capabilities as a conventional portacomp.

*TL:* 12

*Weight:* 1.5 kg

*Price:* Lv1,200

*Portacomp Program/Memory Chips:* A 500 gigabyte chip contains a greater volume of data than a typical small library. This is sufficient to provide an excellent working linguistic translation program or a comprehensive reference guide for a single area of scientific specialisation. A scientific reference chip does not make the user an expert in a field; however, any more than a pile of chemistry reference books makes the owner an expert chemist. A blank chip costs Lv1.

*Translation Chip:* The chip will translate spoken or written known languages. It is purchased with two complete languages on the chip (English/German or Tajik/Farsi, for example) and will translate from one to the other at command. This program can also provide real-time (or near-real-time) translation of voice input.

*Rating:* 4

*Requirements:* None

*Price:* Lv100

*Reference Guide:* A comprehensive reference guide on any one subject is available on chip for a modest price. Possible subjects include (but are not limited to): biochemistry, physics, chemistry, geology of the Earth (or any other well explored world), political history of the Earth (or any other inhabited world) and so forth. The skill level of these guides is equal to their PP and they are available for any Knowledge or Technical skill. Using these guides doubles any time required but allows the user to add half the Guide's level to their own skill check. Use of a reference guide also allows an unskilled user to attempt a skill with only a penalty of -2, not -4. Time for the skill attempt is tripled.

*Rating:* 1 per level

*Requirements:* None

*Price:* Lv40 per Rating

*Language Cracker:* A program which will analyse a spoken or written language and attempt to discover contextual similarities between it and the native language of the program. This is generally a slow and painstaking process with considerable trial and error involved. The language cracker chip confers a +2 DM to Science/Linguistics Skill checks. The language cracker chip also allows a character to learn a language without a native speaker but the language must be purchased as if it were a cross-class skill.

*Rating:* 8

*Requirements:* None

*Price:* Lv120

## COMPUTER STATIONS

Fixed computer stations such as these can be found on board starships, in businesses, in hospitals and even in some ground vehicles. Anywhere that complex or delicate machinery must be operated or bulk information must be processed, a typical computer station can be found. The units can easily interact with any others on the same network, allowing information to be freely accessed from one unit by any other.

These machines have considerably more power at their disposal than a portacomp, although the demands on these resources typically run much higher as well. Most homes do not have these full-size workstations, instead using a network of machines similar in power to a portacomp.

*Static Workstation:*

*TL:* 12

*Internal Storage:* 2+ Exabytes

*Power:* Computer/5

*PP:* 28/11

*Weight:* 10 kg

*Price:* Lv2,500

## PERSONAL POWER

The most common portable power generators are described here.

**Fuel Station:** A solar powered processor that produces electricity from sunlight and then uses it to crack water into hydrogen for vehicle fuel.

The complete station consists of a central unit and 10 solar panels. A tank in the unit can hold 10 vol of liquid hydrogen. The oxygen vent can be connected to a separate oxygen storage tank, if desired.

Each solar panel unfolds into a flat square 10 square metres in area. In sunlight (average intensity in the life zone), each panel generates produces one kilogram of liquid hydrogen per hour (about seven kilograms of oxygen are also produced and normally vented). The station only works during daylight hours.

The station can also be used to produce direct electrical power.

**TL:** 10

**Weight:** 20 kg (with tank empty)

**Price:** Lv3,500

**Fuel Cell:** The portable fuel cell is used to provide power in many wilderness situations and is often used in concert with the fuel station described previously. The fuel cell runs for 10 hours on a full load (10 vol) of fuel.

**TL:** 10

**Weight:** 25 kg

**Price:** Lv2,500

## INDUSTRIAL EQUIPMENT

### **Fabricators**

Fabricators use powdered metals and ceramics to rapidly 'print' out parts and models. The metals and ceramics are subjected to a chemical/heat curing process and are then ready to use. Although the parts are not quite as strong as the original, the ability to produce any spare part while in the field makes them incredibly useful. Most vehicles sold on the Frontier come with a chip containing a complete set of specifications that allow practically any spare part to be created. Note that fabricators do not make complete devices but only individual parts or non-functional 3-D models. It is possible to create all the parts of a more complicated device on the fabricator and then assemble it by hand. However, most fabricators have controls built-in to their firmware to prevent them from being used to make parts for weapons. Of course, military fabricators do not have these constraints and fetch very high prices on the black market. All starship workshops contain the equivalent of a portable fabricator.

**Small Fabricator:** Suitable for making a small parts and models. Can create objects up to 15 cubic centimetres. It takes approximately two or three minutes to print out an average size part on this size of device. Each use requires a new refill of powdered ceramic and the catalyst.

**TL:** 9

**Weight:** 12 kg

**Price:** Lv350

**Refill Weight:** 0.75 kg

**Refill Price:** Lv25

**Portable Fabricator:** Possibly the most common type of fabricator, found throughout human space in the hands of colonists and technicians everywhere. The software and firmware controls on these models are the most restrictive, as they are large enough to turn out the parts for assault weapons. Military fabricators are the same size but lack the firmware controls. This model can create objects up to 100x100x30 centimetres, sufficient for most replacement parts. It takes approximately 10–15 minutes to print out an average size part on this size of device. Each use requires a new refill of powdered ceramic or metal and the catalyst.

**TL:** 10

**Weight:** 220 kg

**Price:** Lv7,500

**Refill Weight:** 20 kg

**Refill Price:** Lv300

## EXPLOSIVES

The most prevalent non-combat explosives in the 24th Century are industrially-produced blocks of plastic explosive. These plastic explosive blocks are all of a uniform weight of one kilogram but their explosive power depends upon the rating they hold. The most commonly used rating for plastic explosive blocks is Plastique9. Multiple blocks of this explosive can be used together to create larger explosions or a single block can be broken down to a fragment of its size for smaller blasts. On less-advanced worlds old-fashioned dynamite, which is relatively easy to manufacture, is produced for local use.

It should be noted that possession of explosives requires a local licence on most worlds and the penalties for noncompliance are severe.

**Plastique-9:**

**TL:** 9

**Weight:** 1 kg

**Damage:** 4d6 radius 2d6

**Price:** Lv100

**Dynamite:**

**TL:** 4

**Weight:** 10 kg

**Damage:** 3d6 radius 2d6

**Price:** Lv50

## MISCELLANEOUS

Other common equipment in the 24th Century is included here.

**Makeup Kit:** The term makeup kit actually can be applied to two very similar items with different purposes. Most makeup kits are

used by people in the public eye (actors and the like) to augment their appearance. But makeup kits are also very handy in undercover or criminal endeavours as well to create disguises.

These kits typically include (but are not limited to) hair colouring dye, modelling putty for altering facial features, coloured contact lenses, false eyelashes and artificial facial hair, necessary adhesives and solvents, coloured facial powder and pencils for toning and highlighting, setting powder, necessary applicators and brushes and a variety of basic skin tone foundation makeup.

Use of the Makeup Kit to create an effective disguise requires either the Deception or Art (Acting) skill. It provides a +2 DM to all Disguise skill checks. Computer-controlled security systems suffer a -1 DM when attempting to penetrate a disguise.

TL: 8

Weight: 5 kg

Price: Lv500

**SofStuf:** SofStuf was originally the brand name for a particular type of foam tissue but the product became so popular that, as often happens, the brand name became the common public term. SofStuf is a soft, absorbent substance that foams up and cures to a fluffy consistency upon contact with atmospheric nitrogen. It is widely used as a facial tissue; as the foamy part is torn from the top of the box which it is packaged in, the substance below comes in contact with the atmosphere and foams up to replace it. It takes less than two seconds for curing to finish.

SofStuf is also used as bandages, rags, washcloths and towels. It comes in a variety of decorative colours.

TL: 8

Weight: 0.25 kg/package

Price: Lv1

## PENTAPOD EQUIPMENT

Pentapod analogs exist for much of the equipment listed in this chapter but they are not widespread. If an analog is available (up to the Referee), it costs at least twice as much as normal equipment but will last nearly forever as a living creature, it self-repairs. Rough treatment will kill a Pentapod analog but would as

easily break Human equipment. All Pentapod equipment listed here has CON, END, DEX and INT stats

**Biosampler:** The biosampler is among the first Pentapod products mass produced for human consumption and the most successful. It is an animal biochemically similar to a human being. It is programmed to determine edibility of plant and animal tissue and communicate that information to its owner. Communication is simple, if it eats the material, it is safe; if it refuses, it is toxic.

Although its appearance is unimportant to its function, the Pentapods have, in one of their few marketing successes, made it soft and furry and programmed a limited pattern of semi-random behaviour to make it more appealing. This pattern becomes predictable after long viewing but the creatures have become popular as children's pets on many Frontier worlds. The Pentapods release a new version every few years, differing only cosmetically from previous versions.

**Water Breather:** In late 2299, the Pentapods released a new product on the market, the water breather. It is a shelled creature that fits tightly to the human face, with a clear section over the eyes, a tube that projects into the mouth and an expandable sac at the chin. The sac expands as the wearer exhales and contracts as the wearer inhales. Meanwhile, the creature filters oxygen and food out of the surrounding water and exudes it into the sac, while filtering carbon dioxide out of the exhaled air. If the breather is kept out of water for more than an hour it will expire, it must be placed in its water-filled case.

It is very popular for casual diving but some fear the results of tearing the sac while working at deep levels. Others feel suffocated to have a living creature covering their faces. Still others are convinced that the water breathers are part of some sort of Pentapod plot (see the Stabiliser, page 142).

The water breather does not require the Swim skill to use effectively and negates the Swim check penalty for consecutive rounds spent underwater.

**Food Converter:** The food converter was a later product for the human market, which failed spectacularly. It resembles a short, fat snake and was capable of converting dextro-amino acid pro-

### Biosampler

| Behaviour and Diet     | Preferred Habitat | Movement Mode(s) | STR | DEX | END    | INT | INS | PCK |
|------------------------|-------------------|------------------|-----|-----|--------|-----|-----|-----|
| Intermittent, Omnivore | Domestic          | Walker           | 1   | 6   | 2      | 1   | 3   | 1   |
| Skills:                | Survival: 3       |                  |     |     |        |     |     |     |
| Attacks:               | 0                 | Armour:          |     | 0   | Number |     | 1   |     |

Weight: 0.5 kg

Price: Lv50

teins and complex carbohydrates to levo-amino acid proteins and carbohydrates, suitable for human consumption. It was even capable of synthesising some vitamins, including the B-complex series but not vitamin D. Unfortunately, the Pentapods only accounted for function, not aesthetics. And in this case, the aesthetics were disastrous. Not for the creature itself, which was merely vaguely unpleasant but for the results. Essentially, it was fed the food to be converted and in the digestion process it converted the amino acids and complex carbohydrates, taking what it needed and excreting the rest. This excreted matter would then be eaten. No one would eat the products and the converter languished in Pentapod storage cysts.

The converter can alter one kilogram of food per hour.

**Biocontacts:** These were among the first Pentapod mass produced bioengineered products for human consumption and were widely distributed at fairly low prices, both as a marketing experiment and as a means of developing a distribution system for additional products. Biocontacts are transparent lenses worn in the eye. When purchased they are dormant and opaque. The purchaser must insert them, keep his eyes closed and remain at rest for eight hours to activate the contacts and allow them to adapt to his body chemistry (this is normally done during a sleep period). Once activated, the biocontacts are specific to the owner and will not function for anyone else. They can be removed and stored or kept in the eyes indefinitely (they allow oxygen to pass freely to the cornea). They draw nourishment from the owner's tears and so must be stored in a special nutrient solution if they are not kept in the eyes.

Biocontacts give the wearer enhanced infrared vision (for night vision) and squinting will give up to a 5x magnification. This changes the increment for Spot Skill checks from three metres to 15.

**Weight:** Insignificant

**Price:** Lv1,000

### Water Breather

| Behaviour and Diet     | Preferred Habitat | Movement Mode(s) | STR     | DEX | END | INT | INS    | PCK |   |
|------------------------|-------------------|------------------|---------|-----|-----|-----|--------|-----|---|
| Intermittent, Omnivore | Aquatic           | Swimmer          | 2       | 4   | 4   | 1   | 3      | 1   |   |
| Skills:                | Survival: 1       |                  |         |     |     |     |        |     |   |
| Attacks:               | 0                 |                  | Armour: |     | 0   |     | Number |     | 1 |

**Weight:** 0.5 kg

**Price:** Lv300

### Food Converter

| Behaviour and Diet     | Preferred Habitat | Movement Mode(s) | STR     | DEX | END | INT | INS    | PCK |   |
|------------------------|-------------------|------------------|---------|-----|-----|-----|--------|-----|---|
| Intermittent, Omnivore | Aquatic           | Swimmer          | 2       | 4   | 4   | 1   | 3      | 1   |   |
| Skills:                | Survival: 1       |                  |         |     |     |     |        |     |   |
| Attacks:               | 0                 |                  | Armour: |     | 0   |     | Number |     | 1 |

**Weight:** 4.3 kg

**Price:** Free (Lv210 after-market)

**Stabiliser:** The stabiliser is an organic cocoon nearly two metres in length and a metre in diameter. Its tough opaque outer shell protects delicate organs inside that can function in place of those of a comatose human being for an indefinite period of time, as long as it takes to get the patient to a medical facility able to treat him.

The stabiliser splits along one side to open and the patient is placed naked inside, upon which, the stabiliser closes once again. Tiny projections pierce the patient's circulatory and nervous systems, providing nutrients, removing wastes and controlling pain. A chemical released into the blood halts the patient's respirations while he is inside the stabiliser.

As long as the construct has oxygenated air to breathe, water to drink and food to consume (about twice that required by a single human), it will remain in operation; patients left inside for more than a week begin to rapidly lose muscle tone, body weight and joint flexibility due to lack of active or passive exercise. Of course, this is a small price to pay for remaining alive while critically wounded.

The stabiliser is the subject of a number of rumours and horror stories associated with a fear and distrust of Pentapod technology and the Pentapods themselves.

**Pentapod Biosuit:** The biosuit is a new product from the Pentapods and is essentially a living protective suit. It has limited effectiveness against weapons but does protect against any encountered toxin or biological agent. The suit is capable of ingesting just about any biological matter and converting it into usable food. It even recycles the user's own wastes, extracting water and any other nutrients. With a small supply of water and biomass, the suit can keep its wearer alive indefinitely in almost any terrestrial environment (provided the user does not think too much about where the food and water are coming from). It is

not suitable as a hostile environment suit, however, nor as a pressure suit. The biosuit has gone a long way to fuelling many a paranoid's darkest nightmare.

**Pentapod Earplugs:** In a wide variety of environments, hearing Protection is desirable. Heavy equipment and weaponry often create intense noise. One of the problems with most hearing protectors is that some necessary sounds are dulled or lost. This problem can range from a minor irritation, such as a conversation being difficult to hear, to a real danger, such as an enemy being undetected when close by.

Advanced electronics have made possible the creation of hearing protectors that work only in the presence of intense noise, going inactive when levels return to normal. But these products are very expensive to purchase and maintain. An alternative is a living earplug produced by Pentapod bioengineers. This creature is largely a tube of muscle the approximate diameter of the human ear canal and possesses its own sense of hearing. When noise reaches a dangerous level, the creature clenches shut, preventing the excess sound from reaching delicate human hearing mechanisms. When the noise level drops, the creature relaxes, allowing normal hearing once again.

The Pentapod earplug cannot be worn for more than six hours at a time or it perishes from lack of nutrients. When not being worn, it is to be stored inside in opaque vial of nutrient fluid. The creature can survive on a minimum of sugar water but it loses its ability to clench until normal nutrients are provided once again.

The earplug is yet another piece of Pentapod technology that provides considerable ammunition for the paranoid. Their thoughts run to: 'What *else* won't it let you hear?'

**Weight:** Insignificant

**Price:** Lv300, plus Lv10 for one month of nutrient solution

### Stabiliser

| Behaviour and Diet     | Preferred Habitat | Movement Mode(s) | STR | DEX | END    | INT | INS | PCK |
|------------------------|-------------------|------------------|-----|-----|--------|-----|-----|-----|
| Intermittent, Omnivore | Aquatic           | Sessile          | 2   | 4   | 4      | 1   | 3   | 1   |
| Skills:                | Survival: 1       |                  |     |     |        |     |     |     |
| Attacks:               | 0                 | Armour:          |     | 0   | Number |     | 1   |     |

**Protection:** 5

**Weight:** 400 kg

**Price:** Lv15,000

### Pentapod Biosuit

| Behaviour and Diet     | Preferred Habitat | Movement Mode(s) | STR | DEX | END    | INT | INS | PCK |
|------------------------|-------------------|------------------|-----|-----|--------|-----|-----|-----|
| Intermittent, Omnivore | Aquatic           | Walker           | 2   | 4   | 4      | 1   | 3   | 1   |
| Skills:                | Survival: 1       |                  |     |     |        |     |     |     |
| Attacks:               | 0                 | Armour:          |     | 0   | Number |     | 1   |     |

**Protection:** 2

**Weight:** 10 kg

**Price:** Lv2,700

**Pod Plants:** Pod plants are a Pentapod creation that has become a very common crop on colony worlds, particularly along the French Arm. In form, it is a hardy, dark green vine that produces pods similar to Terran gourds but have much stronger shells (stronger than Terran ironwood) after aging. Pods are harvestable when they reach a size of one quarter of a litre interior volume but if left to grow, can attain volumes of up to 500 litres. While growing, they are very sensitive to long term outside pressure and, as a consequence, if a wire mesh form is built around a developing pod, the pod will grow to fill the space the form marks out. Pods can be grown to nearly any shape and size before harvesting, making them of great use as crates, barrels, furniture, canteens or many other commonly required items (pod plants are sometimes grown as sculptures).

Once the pod is harvested, it is opened and the pulp inside is scooped out (a small hole is enough). The shell is allowed to air cure for several hours. Fittings such as resealable necks, hinges, latches or handles are then affixed if the pod is to become a reusable container. If the pod is to be used as a shipping crate, the item to be packed is placed inside and packing material is inserted. Two common packing materials are a substance similar to 'SofStuf' and a Pentapod product known as 'Packing Seed'. The opening is then reclosed by gluing the piece removed back into place, making an airtight seal.

**Weight:** Variable

**Price:** Up to Lv60 for a large crate, more if made into furniture or similar.

**Packing Seed:** 'Packing seed' is an agricultural product created by the Pentapods and commonly used with pod plants. Packing seed plants are small, hardy bushes that produce a fruit with a tough skin that shrinks when dried, placing the fibrous meat inside under considerable pressure. When using packing seed as a packing material, an item is placed inside a container, packing seed is dumped in around it and a sharpened stick is run

forcefully down through the fruit, rupturing the skin and allowing the meat inside to expand and fill the container. Packing seed can be a little difficult to remove but it absorbs shock well, making it an excellent packing material for items shipped by orbital catapult.

*Weight (Ruptured):* 3 kg per m<sup>3</sup>

*Price:* Lv1 per m<sup>3</sup>

# WEAPONS

The universe of *2300AD* can often be a dangerous and violent place. Adventuring characters will often need the ability to defend themselves. This section describes both personal and man-portable heavy weapons found in human space.

## Melee Weapons

Although not used very often in combat, melee weapons are very common in criminal circles or when nothing else is available.

*Knife:* A basic hunting or utility knife. Not balanced for throwing.

| Weapon | Price | TL | Mass | Heft | Range               | Damage |
|--------|-------|----|------|------|---------------------|--------|
| Knife  | Lv10  | 1  | 1kg  | —    | Melee (small blade) | 1d6+1  |

*Hatchet:* A small, short-handled axe used for camping. Can be thrown.

| Weapon  | Price | TL | Mass | Heft | Range               | Damage |
|---------|-------|----|------|------|---------------------|--------|
| Hatchet | Lv10  | 1  | 1kg  | —    | Melee (small blade) | 1d6+2  |

*Axe:* A longer-handled tool used for chopping and splitting wood.

| Weapon | Price | TL | Mass | Heft | Range               | Damage |
|--------|-------|----|------|------|---------------------|--------|
| Axe    | Lv25  | 1  | 2kg  | 1    | melee (large blade) | 3d6    |

*Club:* Any sort of heavy, blunt object used as an improvised weapon.

| Weapon | Price | TL | Mass | Heft | Range            | Damage |
|--------|-------|----|------|------|------------------|--------|
| Club   | —     | 1  | 1kg  | —    | Melee (bludgeon) | 2d6    |

*Shortsword:* A short-bladed weapon, like a machete.

| Weapon      | Price | TL | Mass | Heft | Range               | Damage |
|-------------|-------|----|------|------|---------------------|--------|
| Short Sword | Lv50  | 1  | 1kg  | —    | Melee (small blade) | 2d6    |

*Longsword:* Typical of long-bladed slashing weapons, such as the Cold Mountain Demon-sword.

| Weapon     | Price | TL | Mass | Heft | Range | Damage |
|------------|-------|----|------|------|-------|--------|
| Long Sword | Lv100 | 1  | 1kg  | 1    | 1.5 m | 3d6    |

*Wakizashi* This Japanese-style shortsword is almost always made as a pair with the longer katana.

| Weapon    | Price | TL | Mass | Heft | Range               | Damage |
|-----------|-------|----|------|------|---------------------|--------|
| Wakizashi | Lv800 | 3  | 1kg  | -1   | Melee (large blade) | 2d6+2  |

*Katana:* This Japanese-style longsword is renowned both for its quality and its connection to the ideal of the samurai.

| Weapon | Price   | TL | Mass | Heft | Range               | Damage |
|--------|---------|----|------|------|---------------------|--------|
| Katana | Lv1,200 | 3  | 2kg  | 1    | Melee (large blade) | 3d6+   |

*Ceramic Knife* The ceramic knife is a tanto-style long knife made out of high-density ceramic. It is as strong as steel but as sharp as glass and remains sharp longer than a steel weapon.

| Weapon        | Price | TL | Mass | Heft | Range               | Damage |
|---------------|-------|----|------|------|---------------------|--------|
| Ceramic Knife | Lv150 | 9  | 1kg  | —    | Melee (Small Blade) | 3d6    |

*Wire Knife:* The wire knife was originally designed as a cutting tool for the beanstalk projects. The blade consists of an elliptical loop of single-fibre nanotube, doped with superconducting ceramic. When an electrical charge is passed through the blade, the superconductor holds it rigid. With power turned off, the loop of wire can be retracted into the handle. Though nanotube is very strong, the single-fibre strand, when held rigid by the charge, is relatively fragile and can be snapped off by high-density objects.

| Weapon     | Price | TL | Mass  | Heft | Range               | Damage |
|------------|-------|----|-------|------|---------------------|--------|
| Wire Knife | Lv200 | 12 | 0.3kg | —    | Melee (Small Blade) | 3d6    |



**Puke Stick:** The puke stick is a prisoner/riot control device. When it hits or even touches, a target, a specially modulated pulse of electricity is sent into the victim, generally making him nauseated and often violently ill. Most people are not capable of putting up a great deal of resistance if they are puking their guts out.

**Effect:** Puke sticks, like stunners, are non-lethal and do not inflict normal damage. A character struck by a puke stick must make an Endurance check with a negative DM equal to the damage (after armour is subtracted). If this Endurance check is failed the character is violently ill (−4 to all actions, 1/3 normal Move Rate). The effect lasts for Effect x five minutes. If the Endurance check is successful, the character is unaffected by the weapon and the damage is ignored.

| Weapon     | Price | TL | Mass | Heft | Range            | Damage |
|------------|-------|----|------|------|------------------|--------|
| Puke Stick | Lv550 | 10 | 1kg  | 1    | Melee (Bludgeon) | 2d6+2  |

**Shock Baton:** Designed for police and prison work, short versions of these weapons are much favoured by muggers and thieves.

**Effect:** Shock batons, like stunners, are non-lethal and do not inflict normal damage. A character struck by a shock must make an Endurance check with a negative DM equal to the damage (after armour is subtracted). If this Endurance check is failed the character is effectively stunned and at −4 to all actions and 1/3 normal Move Rate). The effect lasts for Effect x five minutes. If the Endurance check is successful, the character is unaffected by the weapon. However, in all cases, half of the damage from the shock baton is real.

| Weapon      | Price | TL | Mass | Heft | Range            | Damage |
|-------------|-------|----|------|------|------------------|--------|
| Shock Baton | Lv320 | 9  | 1kg  | —    | Melee (Bludgeon) | 2d6    |

**Shock Glove:** Shock gloves have much the same effect as the baton but are more likely to be used by security guards and the military, not to mention the underworld.

**Effect:** Shock gloves, like stunners, are non-lethal and do not inflict normal damage. A character struck by shock gloves must make an Endurance check with a negative DM equal to the damage (after armour is subtracted). If this Endurance check is failed the character is knocked unconscious. The effect lasts for Effect x five minutes. If the Endurance check is successful, the character is at −2 to all actions for Effect x two minutes. In any case, each hit from the shock gloves results in one point of real damage.

| Weapon      | Price | TL | Mass  | Heft | Range         | Damage |
|-------------|-------|----|-------|------|---------------|--------|
| Shock Glove | Lv250 | 10 | 0.4kg | —    | Melee (Touch) | 3d6    |

## FIREARMS

There are three general types of projectile weapons in general use throughout humanity in the 24th Century: conventional rifles, binary propellant rifles and gauss rifles.

**Conventional Rifles:** Conventional rifles fire a fixed caseless round, with the bullet embedded in a solid rectangular block of propellant. The round itself consists of a dense metallic core surrounded by a low-friction sabot, which abrades in the barrel and falls away after the bullet leaves. This gives the round a longer range and flatter trajectory, which improves accuracy. Virtually all civilian rifles are conventional rifles but they have mostly been replaced in military service by gauss and binary propellant rifles.

**Binary Propellant Rifles:** Binary propellant ammunition consists of the bullet itself and a separate set of gas propellants. The propellant mixes are separately inert but when combined become explosive. In operation, the two gases are injected into the firing chamber behind the bullet and combine explosively to propel the round. The main advantage is that the compressed gases are much less bulky than conventional rounds and an individual soldier can carry more ammunition. When used with a rangefinder the amount of propellant can be adjusted to fit the range and the round follows a flatter trajectory than other weapons.

**Gauss Rifles:** Gauss rifles are linear magnetic accelerators which fire fin-stabilised flechettes (the weapons can be adjusted to give the rounds a spin if fired in vacuum). Usually the magazine for the gauss rifle also contains a battery pack to power the gun.

Virtually all rifles incorporate basic optical sights. Also, as damage potentials have increased, weapons have incorporated more elaborate recoil-absorbing features. Most long range rifles also have a gunner activated laser range finder, which can be used in conjunction with computer-controlled fuses on some propelled grenades to improve accuracy and hitting power. The listed prices include a basic 1x optical sight but any additional sight features have to be purchased separately.

### Anti-Armour Ammunition

Some ammunition has anti-armour characteristics, which are named Semi-Armour-Piercing (SAP), Armour-Piercing (AP) and Super-Armour-Piercing (Super-AP). These have the following effects:

**SAP** rounds ignore a number of points of armour equal to half the number of dice they roll for damage, dropping fractions and ignoring any modifiers. Thus an SAP round normally doing 3d6−2 damage ignores one point of armour (half of 3 is 1.5, rounded down to 1).

AP rounds ignore a number of points of armour equal to the number of dice they roll for damage, ignoring modifiers. Thus a weapon doing 2d6+2 damage ignores two points of armour when using AP ammunition.

Super-AP rounds ignore a number of points of armour equal to double the number of dice they roll for damage. So a weapon doing 3d6-2 damage using Super-AP ignores the first six points of armour the round encounters.

**Grenade Launchers:** Most modern service rifles incorporate a grenade launcher for increased firepower. On most of these weapons (the AS-89 is a notable exception), the grenade launcher can be swapped-out for another weapon, like a shotgun or sonic stunner.

## CURRENT SERVICE RIFLES

The following rifles are currently being used by major military forces in the 24th Century. All of these weapons are considered Piercing type. In addition, weapons using APHE ammo, as well as all Gauss weapons, are automatically considered to be using AP ammo, with the bonuses as listed.

**Rottman Sk-19:** Now the standard service weapon of the German Army, the Sk-19 is clearly a progressive development of the Traylor Arms M-2 Assault Rifle. The main improvements over the M-2 consist of the substitution of a reliable binary propellant system for fixed cartridges and the inclusion of an integral 30 millimetre grenade launcher in the stock below the barrel. The binary propellant system includes a muzzle velocity governor keyed to the fire select switch, patterned after that on the French FAM-90. When on the burst setting, muzzle velocity is considerably reduced giving an extremely controllable autofire weapon. The resulting combination of a high rate of fire, ease of control, the shattering punch of the nine millimetre APHE round and the option of 30 millimetre grenade fire makes the SK-19 the most devastating close-in assault weapon in service anywhere.

*Type:* 9mm binary propellant assault rifle (with integral 30mm grenade launcher) *Country:* Germany

*Length:* 75 cm

*Mass (empty):* 4kg *Action:* Single shot or bursts

*Ammunition:* 9x12mm APHE

*Muzzle Velocity:* 700mps (area fire 400mps)

*Magazine:* 50-round box magazine with separate propellant gas bottle with charge for 600 aimed shots or 200 bursts

*Magazine Mass:* 0.5kg

*Recharge Bottle Mass:* 0.1kg

*ROF:* 900rpm

*Cost:* Lv1,320, Lv15 for 50 round disposable magazine, Lv10 for recharge bottle

**Segetov AS89 (Avtomat Segetov 2289):** The standard Russian and Ukrainian service weapon, the AS89 incorporates a reliable optical sight and an integral 30 millimetre G2 grenade launcher. The AS89 is aggressively exported and finds its way into the armies of many poorer nations, along with mercenaries, criminals and terrorists. This gun cannot make use of computer-controlled fused

grenades without replacing the grenade launcher and sight.  
*Type:* 4.54mm gauss rifle with integral 30 mm grenade launcher

*Country:* Russia

*Length:* 73cm

*Mass (empty):* 4kg

*Action:* Single shot or burst

*Ammunition:* 4.54x21mm flechette

*Muzzle Velocity:* 1,530mps

*Magazine:* 60-round box magazine with integral power cell

*Magazine Mass:* 0.3kg

*RoF:* 800rpm

*Price:* Lv1,350, Lv10 for a 60 round disposable magazine with power cell.

For grenade launcher stats, see Combat Rifle Integral Grenade Launcher (page 158).

**Traylor Arms M5A1:** The M5A1 is a progressive development of the old M2 assault rifle. The M5A1 is a binary-propellant design, incorporating a three round 30 millimetre grenade launcher, along with hardened sights equipped with a red-dot, low-light and telescopic options, complete with an active/passive rangefinder. The rangefinder is used to feed fusing information to the grenades, enabling them to explode at set distances for enhanced effectiveness against dug-in troops.

While Army troops use the M-4A1 gauss rifle, Marines and SPECFOR troops prefer the M5A1.

*Type:* 9mm binary propellant assault rifle

*Country:* USA

*Length:* 75cm

*Mass (Unloaded):* 3kg

*Action:* Single shot or bursts

*Ammunition:* 9x40mm APHE

*Muzzle Velocity:* 1,200mps

*Magazine:* 40 rounds (separate propellant bottles for 120 shots)

*Magazine Mass:* 0.4kg

*Propellant Bottle Mass:* 0.1kg

*RoF:* 700rpm

*Price:* Lv1,740, Lv10 for magazine of 40 rounds, Lv10 for set of propellant bottle

For grenade launcher stats, see Combat Rifle Integral Grenade Launcher (page 158).

**Guiscard FAM-90 (Fusil Automatique Magnetique 2290):** The standard infantry weapon of first-line French infantry, the FAM-90 gauss rifle fires single shots at high velocity, giving good accuracy. It is designed to fire four round bursts so rapidly that the fourth has fired before the first leaves the barrel, giving it improved controllability on automatic fire. It does not have a full-auto function. The optic sights incorporate a red-dot option, along with a low power laser range finder. The range-finder is used to feed information to the grenade launcher. An HR17 30 millimetre grenade launcher is mounted below the barrel and is designed to fire fused grenades. The tight four-round burst 'to damage' gives +1 DM to attack.

*Type:* 4.5mm Gauss rifle with integral 30mm grenade launcher  
*Country:* France  
*Length:* 76cm  
*Mass (empty):* 4.5kg  
*Action:* Single shot or bursts  
*Ammunition:* 4.5x20mm flechette  
*Muzzle Velocity:* 1,600mps  
*Magazine:* 60-round box magazine with integral power cell magazine  
*Magazine Mass:* 0.5kg  
*RoF:* 2,000rpm in 4-round burst mode  
*Price:* Lv2,100, Lv20 for 60round disposable magazine

For grenade launcher stats, see Combat Rifle Integral Grenade Launcher (page 158).

*Darlan Fabrique FTE-10 (Fusil de Tireur d'Élite-10):* Generally, each French squad contains one FTE-10 (or similar) sniper rifle to use for long-range. The Fusil de Tireur d'Élite-10 is a very low-signature weapon, which makes it excellent for harassment fire from concealment. The round will have hit its target well before the shockwave of its passage will have reached any observers. The FTE-10 can also penetrate light vehicle armour at reasonable ranges.

Due to its great physical length, the FTE-10 has been nicknamed the 'Kentucky long rifle' among American soldiers. Despite being long and bulky, the accurate, long-range fire-power makes it a useful weapon to any infantry unit

The FTE-10 comes equipped with an electronic sight with red-dot, imaging, telescopic, low-light and thermal imaging options.

*Type:* 10mm Gauss sniper rifle  
*Country:* France  
*Length:* 192cm  
*Mass:* 12.5kg  
*Action:* Single shot  
*Ammunition:* 10x37mm flechette  
*Muzzle Velocity:* 1,670mps  
*Magazine:* 10-round box magazine. Separately loaded 30-round power cell.  
*Magazine Mass:* 0.5kg  
*RoF:* 50rpm

## FIREARMS LAWS

Each nation and colony has a stated Law Level, which describes, amongst other things, the legality of certain classes of weapons. It is possible to own weapons that would be otherwise banned at a certain Law Level but one must show a justified need and purchase the required permits. Permits are Lv100 per Law Level (so Law Level 8 requires a Lv800 permit), last for one year and allow the holder to own weapons one Law Level below that which is normally permitted.

*Price:* Lv3,255, Lv60 for box of 100 flechettes, Lv10 for disposable power cell

*Yen Shan State Armoury Type-81 Storm Gun:* Shortly before the Central Asian War, there was a flurry of interest in man-carried heavy calibre 'storm guns', mostly brought on by Manchuria's adoption of the Type-81. The storm gun was intended to provide light anti-vehicle and anti-bunker fire and the exploding round was expected to give a good area fire capability. In service, however, the weapon proved disappointing. Despite being out of service with most Core nations, the Type-81 has received a great deal of interest from colonial militias, especially those unable to afford more expensive support weapons like plasma guns. It includes a basic optical scope with a red dot sight but with no other options.

*Type:* 20mm binary propellant storm gun  
*Country:* Manchuria  
*Length:* 163cm  
*Mass:* 12kg  
*Action:* Single shot  
*Ammunition:* 20x31mm APHE  
*Muzzle Velocity:* 840mps  
*Magazine:* 10-round box magazine; separately loaded internal gas bottles with charge for 100 rounds  
*Magazine Mass:* 2kg  
*Propellant Bottle Mass:* 2kg  
*RoF:* 30rpm  
*Price:* Lv1,740, Lv60 for box of 20 rounds, Lv20 for recharge bottle

| Weapon  | TL | Range | Required Skill | Damage       | Magazine | Auto | Recoil     | Cost                 | Mass (loaded) | Ammo Cost |
|---------|----|-------|----------------|--------------|----------|------|------------|----------------------|---------------|-----------|
| Sk-19   | 12 | Rifle | Gun Combat     | 4D6 Super-AP | 50       | 5    | 1/0 (auto) | Lv1,320              | 4.6kg         | Lv15      |
| AS89    | 11 | Rifle | Gun Combat     | 3d6+3 AP     | 60       | 5    | 1          | Lv1,350              | 4kg           | Lv10      |
| M5A1    | 12 | Rifle | Gun Combat     | 4d6+1 AP     | 40       | 4    | 1          | Lv1,740              | 3.5kg         | Lv10      |
| FAM-90  | 12 | Rifle | Gun Combat     | 4d6+1 AP     | 40       | 3    | 1/0 (Auto) | Lv2100               | 5.0kg         | Lv20      |
| FTE-10  | 12 | Rifle | Gun Combat     | 6d6 AP       | 10       | No   | 2          | Lv3,255 (with scope) | 13kg          | Lv60      |
| Type-81 | 10 | Rifle | Gun Combat     | 5d6 Super-AP | 10       | No   | 3          | Lv1,740              | 16kg          | Lv60      |

## Surplus Service Rifles

The surplus service rifles described here are no longer the primary small arms of their countries' military forces. Nonetheless, the weapons are still in widespread use by a number of smaller forces and retain their effectiveness.

*Ströhl SG-77 (Sturmgewehr-2277):* The Sturmgewehr-2277 has long been replaced by more modern types of weapons in Germany's arsenal; however, the weapon was once widely exported and it can still be found in private hands, as well as in the armouries of many smaller armed forces and militias. It is not fitted standard with a scope

*Type:* 5.5mm conventional assault rifle

*Country:* Germany

*Length:* 75cm

*Mass (empty):* 3kg

*Action:* Single shot or bursts

*Ammunition:* 5.5x40mm fixed cartridge ball

*Muzzle Velocity:* 1,200 mps

*Magazine:* 40 rounds

*Magazine Mass:* 0.3kg

*RoF:* 650rpm

*Price:* Lv280, Lv10 for box of 100 rounds

*Wu-Beijing Type-49 Assault Rifle:* The WuBeijing Type-49 Assault Rifle is unique among modern military arms, its uniqueness stemming from a return to an older design, which uses a trigger-magazine-barrel design layout rather than the more efficient 'bullpup' layout (a magazine-trigger-barrel design).

It comes equipped with a pistol scope with the red-dot option.

*Type:* 7.5mm conventional assault rifle

*Country:* Manchuria

*Length:* 58cm

*Mass (empty):* 2.5kg

*Action:* Single shot or bursts

*Ammunition:* 7.5x32mm fixed cartridge ball

*Muzzle Velocity:* 880mps

*Magazine:* 25 rounds

*Magazine Mass:* 0.2kg

*RoF:* 650rpm

*Price:* Lv230, Lv10 for box of 100 rounds

### Surplus Service Rifles

| Weapon  | TL | Range          | Required Skill | Damage   | Magazine | Auto | Recoil | Cost  | Mass (loaded) | Ammo Cost |
|---------|----|----------------|----------------|----------|----------|------|--------|-------|---------------|-----------|
| SG-77   | 9  | Assault Weapon | Gun Combat     | 3d6+1    | 40       | 4    | 1      | Lv280 | 3.3kg         | Lv10      |
| Type-49 | 10 | Assault Weapon | Gun Combat     | 3d6+2    | 25       | 4    | 2      | Lv230 | 2.7kg         | Lv10      |
| M-2     | 10 | Rifle          | Gun Combat     | 3d6+2 AP | 10       | 4    | 2      | Lv260 | 3.4kg         | Lv15      |

## WEAPON OFFENSES

Possession of an illegal weapon holds a variety of penalties, based on the Law Level of a given nation or world. For Low Law regions, the penalty will be little more than confiscation of the weapon and a fine (Law Level x Lv500). For Moderate Law Areas, the penalties include confiscation, a fine (Law Level x Lv1,000) and possible jail time (Will Save vs. DC (Law Level x 2)). Jail time is equal to the Law Level, in months. For high law worlds, the same applies, although the fine is Law Level x Lv2,000 and there is no save to avoid jail time. In Extreme Law areas, a character is more likely to get shot out of hand than arrested. Use of a weapon in the commission of a crime will result in automatic jail time, no matter the Law Level.

*M-2 Assault Rifle:* The Traylor Arms M-2 'nine forty-four' assault rifle was one of the most popular weapons of its day in U.S. service and is still a favourite today among paramilitary organisations in the Frontier. Simple and reliable, the M-2 was the first mass-produced weapon to use a 9 millimetre APHE round.

*Type:* 9mm conventional assault rifle

*Country:* USA

*Length:* 79cm

*Mass (empty):* 3kg

*Action:* Single shot or bursts

*Ammunition:* 9x44mm fixed cartridge APHE

*Muzzle Velocity:* 800mps

*Magazine:* 30 rounds

*Magazine Mass:* 0.4kg

*RoF:* 550rpm

*Price:* Lv260, Lv15 for box of 100 rounds

## Civilian Weapons

These are the most common civilian rifles in the 24th Century.

*Stracher SS7 (Scharfshutzen Modell 7):* The Stracher SS7 is the only mass-produced air rifle currently in use as a hunting weapon (although a variety of low-power air rifles are used for recreation target shooting). The weapon is powered by compressed air from a central reservoir, which holds sufficient pressure for 20 shots at high pressure and 30 more at low pressure. The weapon can be recharged by hand but only to the low pressure level. A small, solar-powered compressor is available to accompany the weapon, which sees good sales along the French and Manchurian Arms.

*Type:* 4mm sporting rifle  
*Country:* Austrovenia  
*Length:* 72cm  
*Mass (empty):* 1.0kg  
*Action:* Single shot  
*Ammunition:* 4x35mm flechette  
*Muzzle Velocity:* 480mps  
*Magazine:* 20-round box  
*Magazine Mass:* 0.1kg  
*Air Recharge Bottle Mass:* 0.5kg  
*RoF:* 120rpm  
*Price:* Lv420, Lv10 for box of 1,000 rounds, Lv10 for recharge bottle

*Guiscard FC-68 (Fusil Chasseur 2268):* The FC-68 was designed with the Frontier colonist in mind and is widely used by French civilians on a variety of worlds. It combines a bull-pup configuration (giving it a distinctly military look, one of its strongest selling features) with full-automatic fire. It does not come with a scope but one may be purchased.

*Type:* 5mm sporting rifle  
*Country:* France  
*Length:* 75 cm  
*Action:* Single shot or bursts  
*Mass (empty):* 1.0kg  
*Ammunition:* 5x15mm fixed cartridge ball  
*Muzzle Velocity:* 630mps  
*Magazine:* 70-round box  
*Magazine Mass:* 0.3kg  
*RoF:* 600rpm  
*Price:* Lv720, Lv20 for box of 300 rounds

*Guiscard FC70 (Fusil Chasseur 2270):* The FC70 was designed to make use of the large quantities of 7.5mm surplus ammunition available on the open market and low firing cost has made it (and other similar rifles) popular. It is widely used both as a target rifle and for medium-sized game hunting. Even as the military inventories of the round are drying up, civilian manufacturers have stepped up to provide ammo for the huge installed base of users. It does not come with a scope but one may be purchased.

*Type:* 7.5mm hunting rifle  
*Country:* France  
*Length:* 102cm

*Mass (empty):* 3.0kg  
*Action:* Single shot  
*Ammunition:* 7.5x40mm fixed cartridge ball  
*Muzzle Velocity:* 910mps  
*Magazine:* 5-round box  
*Magazine Mass:* 0.2kg  
*RoF:* 120rpm  
*Price:* Lv650, Lv10 for box of 100 rounds

*Rockwell 12-81 Magnum:* Deservedly enjoying a reputation as the most powerful sporting rifle in known space, the 12-81 can only be fired from a rest with the integral bipod extended and even then the provision of an in-stock shock absorber is necessary to avoid injury to the firer. The rifle was originally designed to provide a weapon with a high first-round killing capability against the Beowulf Dragonbat and other dracoforms native to that world but has since enjoyed wide use in the armed forces of several nations as a long-range sniper rifle. The French FTE10 gauss rifle is in many ways a more modern version of the Rockwell 12-81 Magnum. The 12-81 does not come with a scope but one may be purchased.

*Type:* 12mm big game and sniper rifle  
*Country:* United Kingdom  
*Length:* 144cm  
*Mass (empty):* 14kg  
*Action:* Single shot  
*Ammunition:* 12x81mm fixed cartridge ball  
*Muzzle Velocity:* 1,100mps  
*Magazine:* 6-round box  
*Magazine Mass:* 0.5kg  
*RoF:* 30rpm  
*Price:* Lv1,200, Lv50 for box of 10 rounds

## SHOTGUNS

Shotguns are conventional firearms, firing large-calibre, low-velocity rounds. Payloads can include anything from birdshot, which fires many dozens of small metal or ceramic balls, to buckshot, which is a small number of large-diameter metal balls, to slugs and other specialty rounds.

*Stracher 'Wolf' Hunting shotgun:* The Wolf is a classic over/under double-barrelled shotgun, common throughout Europe and the French Arm as a gentleman's hunting shotgun. The Wolf is a luxury item, with its engraved barrel and custom furniture made from wood imported from Beta Canum. Double-barrelled shotguns with similar performance can be purchased for as little as Lv180.

## Civilian Weapons

| Weapon    | TL | Range   | Required Skill | Damage | Magazine | Auto | Recoil | Cost    | Mass (loaded) | Ammo Cost |
|-----------|----|---------|----------------|--------|----------|------|--------|---------|---------------|-----------|
| SS-7 (HP) | 9  | Rifle   | Gun Combat     | 3d6-1  | 20       | No   | 0      | Lv420   | 1.1 kg        | Lv10      |
| (LP)      | 9  | Shotgun | Gun Combat     | 2d6-1  | 20       | No   | 0      | —       | —             | —         |
| FC-68     | 9  | Rifle   | Gun Combat     | 3d6-1  | 70       | 4    | 1      | Lv720   | 1.3kg         | Lv20      |
| FC-70     | 10 | Rifle   | Gun Combat     | 3d6    | 5        | No   | 1      | Lv650   | 3.2 kg        | Lv10      |
| 12-81     | 10 | Rifle   | Gun Combat     | 5d6    | 6        | No   | 3      | Lv1.200 | 14.5kg        | Lv50      |

*Type:* 18mm hunting shotgun  
*Country:* Austrovenia  
*Mass (Empty):* 2.2kg  
*Length:* 102cm  
*Action:* Single shot  
*Ammunition:* 18x60mm fixed cartridge buckshot (9x8mm slugs)  
*Muzzle Velocity:* 410mps  
*Magazine:* 2-round internal  
*ROF:* 30rpm  
*Price:* Lv2,700, Lv20 for box of 100 rounds

*Traylor Model 10 Riot Gun:* This short-barrelled weapon comes with a folding stock and variants of this design are a favourite with colonists on the Frontier, as well as police services throughout human space, including the Core.

*Type:* 18mm pump shotgun  
*Country:* USA  
*Length:* 96cm  
*Mass (Empty):* 3.0kg  
*Action:* Single shot  
*Ammunition:* 18x60mm fixed cartridge buckshot (9x8mm slugs)  
*Muzzle Velocity:* 428mps  
*Magazine:* 9-round tube  
*Mass of 9 loaded rounds:* 0.4kg  
*RoF:* 60rpm  
*Price:* Lv750, Lv20 for box of 100 rounds

*DunArmCo Close Assault Gun:* This fully-automatic shotgun is often used by police and anti-insurgent forces. It is also a common weapon in light attack drones.

*Type:* 18mm automatic shotgun  
*Country:* Australia  
*Length:* 68cm  
*Mass (empty):* 3.5kg  
*Action:* Single shot or bursts  
*Ammunition:* 18x60mm fixed cartridge buckshot (9x8mm slugs)  
*Muzzle Velocity:* 410mps  
*Magazine:* 20-round box  
*Magazine Mass:* 0.5kg  
*RoF:* 500rpm  
*Price:* Lv1,340, Lv20 for box of 100 rounds

### SPECIALTY SHOTGUN ROUNDS

Shotguns are often characterised as ‘the poor man’s grenade launcher’ due to the wide variety of loads available for them. Note that fully automatic shotguns cannot use the grenade or Stingball

rounds, as the propellant in these rounds is insufficient to work the action of the gun. It is possible to fire the rounds by manually working the weapon’s action but this takes an extra round.

| Round      | Effect                | Price               |
|------------|-----------------------|---------------------|
| Slug       | 5d6                   | Lv40 per 25 rounds  |
| AP Slug    | 5d6 AP                | Lv100 per 25 rounds |
| Flechette  | 3d6 damage            | Lv20 per 25 rounds  |
| Grenade    | 2d6 damage, 3m radius | Lv500 per 25 rounds |
| Sting Ball | 3d6 Stun Damage       | Lv120 per 25 rounds |

Slug is a solid, rifled slug used for big-game hunting.

The AP slug is a solid slug wrapped around a tungsten penetrator core.

Flechette ammo is an alternative to conventional shot and consists of dozens of three millimetre fin-stabilised darts. The darts are more accurate and penetrate light cover better, giving flechettes a +1 DM at Short and Medium Ranges. (Note that flechette rounds have a –2 DM to hit in a vacuum.)

Grenade rounds are just small, high-explosive grenades.

Sting Ball rounds are similar to normal buckshot but instead of being packed with eight millimetre lead balls, the rounds are packed with eight millimetre hard rubber balls.

### HANDGUNS

As with civilian rifles, a wide variety of handgun types can be found in the 24th Century. The weapons that are listed represent some of the range of capabilities in 24<sup>th</sup> Century handguns.

The principal types of handguns are revolvers and automatics. Revolvers are fed from a revolving cylinder, while automatics are fed from removable magazines. Automatics are more efficient but revolvers are more reliable. A revolver is carried with the firing pin resting on an empty chamber, which is not possible for an automatic unless the pistol is carried without a round in the chamber, in which case, it must have the slide worked to chamber a round from the magazine before firing.

Because of their short range and limited stopping power, pistols are not generally issued to combat troops. Officers often carry a pistol as a badge of rank more than an actual weapon; a combat

| Weapon            | TL | Range   | Required Skill | Damage | Magazine | Auto | Recoil | Cost    | Mass (loaded) | Ammo Cost |
|-------------------|----|---------|----------------|--------|----------|------|--------|---------|---------------|-----------|
| Wolf              | 9  | Shotgun | Gun Combat     | 4d6    | 2        | No   | 2      | Lv2,700 | 2.2 kg        | Lv20      |
| Model-10          | 10 | Shotgun | Gun Combat     | 4d6    | 9        | No   | 2      | Lv750   | 3.4kg         | Lv20      |
| Close Assault Gun | 10 | Shotgun | Gun Combat     | 4d6    | 20       | 4    | 3      | Lv1,340 | 4kg           | Lv20      |

rifle is generally carried as well. Some troops buy heavy pistols and value them for their handiness at close range, their low bulk often enabling the firer to get off the critical first shot.

Gauss and binary propellant pistols are very rare and very expensive, as the extra complexity involved in their design more than offsets the increase in firepower.

*Hancock Nine-Twenty-Three Enforcer:* A common American police and personal defence weapon. A plastic reloader allows all six rounds to be inserted with a single minor Action. Like most modern revolvers, it fires from the lowest cylinder, putting the barrel more in the centre of mass of the gun.

*Type:* 9mm police revolver  
*Country:* USA  
*Length:* 21cm  
*Mass (empty):* 0.5kg  
*Action:* Single shot  
*Ammunition:* 9x23mm fixed cartridge ball  
*Muzzle Velocity:* 390mps  
*Magazine:* 6-round cylinder  
*Mass of 6 rounds in Reloader:* 0.1kg  
*RoF:* 1  
*Price:* Lv170, Lv20 for box of 100 rounds

*Stracher Modell 6:* This compact pistol uses the same high-velocity ammunition as the MP-67 series.

*Type:* 6 mm automatic  
*Country:* Austrovenia  
*Length:* 32cm  
*Mass (empty):* 0.7kg  
*Action:* Single shot  
*Ammunition:* 6x27mm fixed cartridge ball  
*Muzzle Velocity:* 860mps  
*Magazine:* 22-round box  
*Magazine Mass:* 0.3kg  
*RoF:* 120rpm  
*Price:* Lv370, Lv30 for box of 100 rounds

*Traylor Model 57 (Chip Traylor Special):* A common American military and police weapon.

*Type:* 9mm automatic  
*Country:* USA

*Length:* 20cm  
*Mass (empty):* 0.6kg  
*Action:* Single shot  
*Ammunition:* 9x24mm fixed cartridge ball  
*Muzzle Velocity:* 460mps  
*Magazine:* 20-round box  
*Magazine Mass:* 0.13kg  
*RoF:* 120rpm  
*Price:* Lv300, Lv20 for box of 100 rounds

*Rockwell 12-39 Magnum:* Designed and marketed as a companion hunting weapon for the massive Rockwell 12-81 Magnum rifle, the 12-39 revolver is the most powerful production handgun mass-produced in Human space. Although calling a production run of a mere 250 guns per year 'mass-produced' is perhaps stretching things.

*Type:* 12mm hunting revolver  
*Country:* Britain  
*Mass (Empty):* 1.8kg  
*Length:* 44cm  
*Mass (empty):* 1.8kg  
*Action:* Single shot  
*Ammunition:* 12x39mm fixed cartridge ball  
*Muzzle Velocity:* 620mps  
*Magazine:* 6-round cylinder  
*Magazine Mass:* 0.3kg  
*RoF:* 60rpm  
*Price:* Lv900, Lv150 for box of 100 rounds

*Stracher P11 mm (Pistole 11 mm Magnum):* A conventional 11mm automatic pistol. It is the most powerful production magazine-fed handgun in human space.

*Type:* 11 mm automatic  
*Country:* Austrovenia  
*Length:* 35cm  
*Mass (empty):* 1.5kg  
*Action:* Single shot  
*Ammunition:* 11x35mm fixed cartridge ball  
*Muzzle Velocity:* 580mps  
*Magazine:* 7-round box  
*Magazine Mass:* 0.2kg  
*RoF:* 120rpm  
*Price:* Lv350, Lv20 for box of 100 rounds

| Weapon   | TL | Range   | Required Skill | Damage | Magazine | Auto | Recoil | Cost   | Mass (loaded) | Ammo Cost |
|----------|----|---------|----------------|--------|----------|------|--------|--------|---------------|-----------|
| 9-23     | 10 | Handgun | Gun Combat     | 3d6    | 6        | No   | 1      | Lv170  | 0.5kg         | Lv20      |
| Modell-6 | 11 | Handgun | Gun Combat     | 3d6 AP | 22       | No   | 1      | Lv370  | 1.0 kg        | Lv30      |
| M-57     | 11 | Handgun | Gun Combat     | 3d6    | 20       | No   | 1      | Lv300  | 0.73kg        | Lv20      |
| 12-39    | 10 | Pistol  | Gun Combat     | 4d6+1  | 6        | No   | 2      | Lv900  | 2.1kg         | Lv150/100 |
| P-11     | 9  | Pistol  | Gun Combat     | 4d6    | 6        | No   | 2      | Lv350  | 1.7kg         | Lv50      |
| MX-99    | 12 | Handgun | Gun Combat     | 4d6 AP | 12       | No   | 2      | Lv1450 | 2.1kg         | Lv12      |

*Traylor MX-99 Gauss Pistol:* More of a target pistol than a combat weapon, the MX-99 does see some military sales but mostly in personal purchases by officers. It is practically a symbol of office for mercenary officers along the Chinese Arm.

Type: 3mm gauss  
 Country: USA  
 Length: 41cm  
 Mass (empty): 1.7kg  
 Action: Single shot  
 Ammunition: 3x22 mm flechette  
 Muzzle Velocity: 1,540mps  
 Magazine: 12-round box  
 Magazine Mass: 0.4kg  
 RoF: 120 rpm  
 Price: Lv1,450, Lv12 for box of 20 rounds

### SUBMACHINGUNS AND ASSAULT PISTOLS

*Traylor T-50 Assault Pistol:* A small, selective fire weapon, favoured by criminals and agents alike.

Type: 9mm submachine gun  
 Country: America  
 Length: 40cm  
 Mass (empty): 1.0kg  
 Action: Single shot or bursts  
 Ammunition: 9x20 mm fixed cartridge ball  
 Muzzle Velocity: 750mps  
 Magazine: 40-round box Magazine Mass: 1.2kg  
 RoF: 700rpm  
 Price: Lv700, Lv12 for box of 100 rounds

*Stracher MP-67K Compact Submachinegun:* The smaller cousin of the MP-67, the MP-67K (K for Kurz or short) is little bigger than a large pistol, with almost the same firepower as its bigger relative

Type: 6mm submachine gun  
 Country: Austrovenia  
 Length: 40cm  
 Mass (empty): 1.0kg  
 Action: Single shot or bursts  
 Ammunition: 6x27mm fixed cartridge ball  
 Muzzle Velocity: 830mps  
 Magazine: 25-round box  
 Magazine Mass: 0.7kg  
 RoF: 750rpm  
 Price: Lv900, Lv12 for box of 100 rounds

*Stracher MP-67 PDW (Personal Defence Weapon):* Using a high-powered six millimetre round that is more like a cut-down rifle round than a conventional pistol round, the MP-67 is designed to provide compact and controllable firepower for rear-echelon troops and vehicle crews. It has also found use with police SWAT teams and military Special Forces.

Type: 6mm submachine gun  
 Country: Austrovenia  
 Length: 60cm  
 Mass (empty): 1.7kg  
 Action: Single shot or bursts  
 Ammunition: 6x27mm fixed cartridge ball  
 Muzzle Velocity: 910mps  
 Magazine: 50-round box  
 Magazine Mass: 0.7kg  
 RoF: 900rpm  
 Price: Lv1,100, Lv30 for box of 100 rounds

### AUTOGUNS

Autoguns are a category of crew-served light automatic weapons fed from large capacity drums or flexible cassettes and are typically fired from mounts. They are similar to rifles but their heavier construction enables them to sustain a higher rate of fire over time. Rotary guns are Gatling-style weapons that use multiple rotating barrels to achieve extremely high rates of fire.

*MG-7 (Maschinengewehr Modell 7):* The small-calibre MG-7 was designed as a companion weapon to the SG-77 assault rifle, using the same ammunition. While the SG-77 has been dropped from current inventories, the machine gun carries on. There are rumours of a nine millimetre binary weapon being in development to support the Sk-19, however.

Type: 5.5mm conventional machine gun  
 Country: Germany  
 Length: 107cm  
 Mass (empty): 4kg  
 Action: Single shot or bursts  
 Ammunition: 5.5x40mm fixed cartridge ball  
 Muzzle Velocity: 1,200mps  
 Magazine: 75-round drum or 20- round cassette  
 Magazine Mass: 0.6kg (drum), 1kg (cassette)  
 RoF: 750rpm  
 Price: Lv870, Lv10 for box of 100 rounds, Lv15 for empty drum or cassette

### Submachineguns and Assault Pistols

| Weapon | TL | Range          | Required Skill | Damage | Magazine | Auto | Recoil | Cost   | Mass (loaded) | Ammo Cost |
|--------|----|----------------|----------------|--------|----------|------|--------|--------|---------------|-----------|
| T-50   | 11 | Handgun        | Gun Combat     | 3d6    | 40       | 4    | 1      | Lv700  | 2.2kg         | Lv12      |
| MP-67K | 11 | Handgun        | Gun Combat     | 3d6 AP | 25       | 6    | 2      | Lv900  | 1.7kg         | Lv30      |
| MP-67  | 11 | Assault Weapon | Gun Combat     | 3d6 AP | 50       | 4    | 1      | Lv1100 | 2.4kg         | Lv30      |



**Kasakaia M-97:** This relatively new weapon uses the same ammunition as the new M5 assault rifle to simplify support requirements.

**Type:** 9mm binary machine gun  
**Country:** America  
**Length:** 97cm  
**Mass (empty):** 3.2kg  
**Action:** Single shot or bursts  
**Ammunition:** 9x20mm binary APHE  
**Muzzle Velocity:** 1,200mps  
**Magazine:** 200-round drum or 600-round cassette (includes gas bottles)  
**Magazine Mass:** 1.5kg (drum), 5kg (cassette)  
**RoF:** 1,000rpm  
**Price:** Lv1,450, Lv20 for box of 100 rounds, Lv50 for empty drum or cassette

**Wu-Beijing Type 381 Machinegun:** The Type 381 is typical of many medium machineguns found in arsenals all over Earth and charted space.

**Type:** 7.5mm conventional machine gun  
**Country:** Manchuria  
**Length:** 122cm  
**Mass (empty):**  
**Action:** Single shot or bursts  
**Ammunition:** 7.5x32mm fixed cartridge ball  
**Muzzle Velocity:** 940mps  
**Magazine:** 150-round cassette  
**Magazine Mass:** 2kg  
**RoF:** 900rpm  
**Price:** Lv870, Lv20 for box of 100 rounds, Lv50 for empty cassette

**DunArmCo Mini12:** Virtually a small cannon, the Mini-12 is found in licensed-built and copied forms in just about all militaries as a heavy infantry support weapon.

**Type:** 12mm conventional heavy machine gun  
**Country:** Australia  
**Length:** 144cm

**Mass (empty):** 24kg  
**Action:** Single shot or bursts  
**Ammunition:** 12x95mm fixed cartridge ball  
**Muzzle Velocity:** 940mps  
**Magazine:** 100-round cassette  
**Magazine Mass:** 7kg  
**RoF:** 800rpm  
**Price:** Lv910, Lv30 for box of 100 rounds, Lv50 for empty cassette

**Guiscard F-44 Gauss Gun:** One of the few gauss machineguns in service, the F-44 was developed to ease logistical support for French units carrying the FAM-99 gauss rifle by providing ammunition commonality. The power pack for the weapon is included in the mass and cost of the drum.

**Type:** 4.5 mm crew-served gauss support weapon  
**Country:** France  
**Length:** 130cm  
**Mass (empty):** 20kg  
**Action:** Single shot or bursts  
**Ammunition:** 5.5x25mm flechette  
**Muzzle Velocity:** 1,100mps  
**Magazine:** 5,000-round cassettes  
**Magazine Mass:** 15kg  
**RoF:** 1,200rpm  
**Price:** Lv2,500, Lv20 for box of 100 rounds, Lv50 for empty drum,

**DunArmCo M-600 Rotary Gun:** Sometimes sheer volume of fire is required and when it is the M-600 is the premier light support weapon. It consumes ammunition at a prodigious rate, however.

**Type:** 9mm rotary machinegun  
**Country:** Australia  
**Length:** 97cm  
**Mass (empty):** 25kg  
**Action:** Bursts Only  
**Ammunition:** 9x44mm fixed cartridge APHE  
**Muzzle Velocity:** 1,100mps  
**Magazine:** 1,500-round cassettes

### Autoguns

| Weapon   | TL | Range | Required Skill | Damage         | Magazine  | Auto | Recoil | Cost    | Mass (loaded) | Ammo Cost |
|----------|----|-------|----------------|----------------|-----------|------|--------|---------|---------------|-----------|
| MG-7     | 9  | Rifle | Gun Combat     | 3d6+1          | 75 or 200 | 6    | 2      | Lv870   | 5 kg          | Lv210     |
| M-97     | 12 | Rifle | Gun Combat     | 4d6 Super-AP   | 200/600   | 6    | 2      | Lv1,450 | 4.7kg         | Lv20      |
| Type 381 | 10 | Rifle | Gun Combat     | 3d6+3          | 150       | 4    | 2      | Lv870   | 9kg           | Lv20      |
| Mini-12  | 10 | Rifle | Gun Combat     | 5d6            | 100       | 6    | 3      | Lv910   | 31 kg         | Lv30      |
| F-44     | 12 | Rifle | Gun Combat     | 4d6+1 Super-AP | 5000      | 8    | 2      | Lv2,500 | 35kg          | Lv20      |
| M-600    | 11 | Rifle | Gun Combat     | 4d6 AP         | 1500      | 20   | 2      | Lv1,400 | 60kg          | Lv10      |
| Type 12  | 11 | Rifle | Heavy Weapons  | 6d6 AP         | 50        | 4    | 1      | Lv1,000 | 600kg         | Lv20      |

*Magazine Mass:* 35kg  
*RoF:* 5,000rpm  
*Price:* Lv1,400, Lv10 for box of 50 rounds, Lv50 for empty cassette

*Toho Type 12 Autocannon:* The Type 12 is typical of most light auto-cannons and variations on this weapons can be found everywhere from IFVs to aircraft to anti-missile systems.

*Type:* 25mm conventional autocannon  
*Country:* Japan  
*Length:* 190cm  
*Mass (empty):* 600kg  
*Action:* Single shot or bursts  
*Ammunition:* 25x161mm fixed cartridge APHE  
*Muzzle Velocity:* 1,100mps  
*Magazine:* 50-round drums  
*Magazine Mass:* 15kg  
*RoF:* 660rpm  
*Price:* Lv1,000, Lv20 for box of 50 rounds Lv5 for empty drum

## Lasers

Lasers emit beams of coherent light that can cause damage to a target. The short-duration, high-energy beam produces such a rapid temperature change in a target's surface that it explosively vaporises, causing shock damage to the target. Due to this, laser weapons cannot be used as laser designators for missiles or artillery.

Lasers are typically powered by high-efficiency liquid metallic suspension (LMS) battery packs. Since a battery's discharge rate is insufficient to directly power a strong beam, the battery 'pumps' a fast-discharge homopolar generator, which comprises most of the laser mechanism. The generator stores energy in a rapidly spinning flywheel (about 50,000 rpm) until it has enough for a pulse. LMS batteries are not rechargeable in the field. Rechargeable cells are available, for twice the price and half the number of shots.

Lasers are generally referred to by their output power (in megawatts) and their pulse duration (in hundredths of a second). Thus a 40-01 laser would have an output of 40 megawatts for one one-hundredth of a second. Actual beam energy is a function of the power output multiplied by the pulse duration. Since one watt for one second produces one joule, a 40-megawatt pulse for one one-hundredth of a second would produce four-tenths of a megajoule.

A number of laser weapons are available in the 24th Century. Several are listed here.

*Mueller-Rivera P3 (Pistole3):* The P3 is a very handy lightweight laser. The combination of a low power output and the high discharge rate of the Quinn seven megajoule FDLMS power cell makes for a high cyclic rate of fire and a reasonable area fire capability. The pistol's power cell is worn on the belt and connected to the pistol by means of a 50-gauge power cable.

*Type:* 20-01 laser pistol  
*Country:* Argentina  
*Length:* 27cm  
*Mass (empty):* 1kg  
*Action:* Single shot or bursts  
*Pulse Energy:* 0.2 megajoules  
*Muzzle Velocity:* C  
*Magazine:* 7MJ FDLMS cell (35 pulses)  
*Magazine Mass:* 1kg  
*RoF:* 300rpm  
*Price:* Lv2,100, Lv15 for disposable power cell

*Rortmann Lk1 (Laserkarabiner1):* A very modern and deadly assault weapon, the LK1 combines a powerful 35-01 combat laser with a 30 millimetre grenade launcher. Most of these weapons mount an integrated sight that allows programming of the grenades.

*Type:* 35-01 laser rifle  
*Country:* Germany  
*Length:* 65cm  
*Mass (empty):* 2.5kg  
*Action:* Single shot  
*Pulse Energy:* 0.35 megajoules  
*Muzzle Velocity:* C  
*Magazine:* 12 MJ FDLMS cell (30 pulses)  
*Magazine Mass:* 1kg  
*RoF:* 120rpm  
*Price:* Lv2,550, Lv15 for disposable cell

For grenade launcher stats, see Combat Rifle Integral Grenade Launcher (page 158).

*Gonzalves-Brazilia Luce-3:* One of the oldest laser weapons still in service, the Luce-3 was a fairly clumsy and inefficient design, which remains in use primarily because large numbers were produced, Captured Luce-3s, for example, are the main sniping weapon employed by the armed forces of the Inca Republic.

*Type:* 40-02 laser rifle  
*Country:* Brazil  
*Length:* 95cm  
*Mass (empty):* 2.5kg  
*Action:* Single shot  
*Pulse Energy:* 0.9 megajoules  
*Muzzle Velocity:* C  
*Magazine:* 5 MJ LMS cell (5 pulses)  
*Magazine Mass:* 1kg  
*RoF:* 120rpm  
*Price:* Lv1,850, Lv15 for disposable cell

*Gonzalves-Brazilia Luce-7B:* The Luce-7 replaced the Luce-4 in Brazilian service. Although lower-powered than most laser rifles, it has enough punch to deal with most targets and an integral 30 millimetre GB30B grenade launcher gives it a good area fire capability.

*Type:* 40-01 laser rifle with integral 30mm grenade launcher  
*Country:* Brazil  
*Length:* 69cm  
*Mass (Empty):* 3kg  
*Action:* Single shot  
*Pulse Energy:* 0.4 megajoules  
*Muzzle Velocity:* C  
*Magazine:* 5 mj LMS cell (12 pulses)  
*Magazine Mass:* 1kg  
*RoF:* 120rpm  
*Price:* Lv2,550, Lv15 for disposable cell

*Mueller-Rivera F-19 (Fusile-19):* The Mueller-Rivera F1b is the current service laser with Argentine troops and is widely exported as well. It is the most effective and efficient man-portable laser weapon in use.

*Type:* 70-01 laser rifle  
*Country:* Argentina  
*Length:* 69cm  
*Mass (empty):* 1.5kg  
*Action:* Single shot  
*Pulse Energy:* 0.7 megajoules  
*Muzzle Velocity:* C  
*Magazine:* 12 MJ FDLMS cell (15 pulses)  
*Magazine Mass:* 1kg  
*RoF:* 120rpm  
*Price:* Lv2,150, Lv15 for disposable power cell

*SVB (Snayperskaya Vintovka Belnikarpova):* Although the Belnikarpova is the highest-energy man-portable laser in service with any army, more modern designs produce the same damage at lower power levels. Nonetheless, the SVB remains effective and it is the standard service laser in use by Russia, where it serves as the squad-issue sniper weapon.

*Type:* 120-01 laser rifle  
*Country:* Russia  
*Length:* 83cm  
*Mass (empty):* 2kg  
*Action:* Single shot  
*Pulse Energy:* 0.8 megajoules  
*Muzzle Velocity:* C  
*Magazine:* 6MJ FDLMS cell (6 pulses)  
*Magazine Mass:* 1kg  
*RoF:* 120rpm  
*Price:* Lv2,300, Lv15 for disposable power cell

### Lasers

| Weapon | TL  | Range  | Required Skill | Damage | Magazine | Auto | Recoil | Cost    | Mass  | Ammo Cost |
|--------|-----|--------|----------------|--------|----------|------|--------|---------|-------|-----------|
| P-3    | 12  | Pistol | Energy Pistol  | 3d6+2  | 35       | 2    | 0      | Lv2,100 | 1kg   | Lv15      |
| Lk-1   | 12  | Rifle  | Energy Rifle   | 4d6    | 30       | No   | 0      | Lv2,550 | 3.5kg | Lv15      |
| Luce-3 | 10  | Rifle  | Energy Rifle   | 4d6    | 5        | No   | 0      | Lv1,850 | 3.5kg | Lv15      |
| Luce-7 | 11  | Rifle  | Energy Rifle   | 5d6    | 30       | No   | 0      | Lv2,250 | 2.5kg | Lv15      |
| F-19   | 12  | Rifle  | Energy Rifle   | 6d6    | 15       | No   | 0      | Lv2,150 | 2.5kg | Lv15      |
| SVB    | 11` | Rifle  | Energy Rifle   | 5d6    | 6        | No   | 0      | Lv2,300 | 3.0kg | Lv15      |

## PLASMA GUNS, MAN-PORTABLE (PGMPs)

### PLASMA GUN NOTES

The plasma gun contains a laser ignition system in the weapon that superheats a hydrogen-telluride fuel pellet to a plasma state. The plasma is contained in the ignition chamber briefly and then allowed to escape through a magnetically focused field along the weapon's barrel. The high velocity plasma bolt is initially about two millimetres in diameter but begins to dissipate almost immediately. Dissipation is minimised by having the bolt ride a 'tunnel' of heated air generated by a laser beam from the weapon. Because the plasma bolt rides a laser beam to its target, plasma guns are sometimes referred to as plasers.

The ammunition for the weapon consists of photonic core plaser cells, each containing a fast discharge battery to pump the weapon's laser ignition and pathfinder beam and the fuel pellet for the plasma bolt. After firing, the spent cells are ejected and are not reusable. Some care must be exercised in the selection of the location of the plasma gunner as the ejected cells are extremely hot, with semi-molten centres and can cause minor burn injuries to other troops in the way or even ignite dry, flammable materials (1d6-2 damage).

*Jaschonek Fabrikant A-9 Sturmgewehr:* The A-9 is the newest and most compact, man-portable plasma gun issued to any military. It is intended to be used as an assault rifle rather than as a squad support weapon. While not seriously considered as a Sk-19 replacement, the A-9 is issued on an experimental basis to back up the Sk-19.

*Type:* Man-portable 5MW plasma gun  
*Country:* Germany  
*Length:* 83cm  
*Mass (empty):* 4.5kg  
*Action:* Single shot  
*Ammunition:* 10x70mm 5MW photonic core plaser cell  
*Magazine:* 6 cells in rotating cylinder magazine  
*Ammunition Mass:* 0.3kg per cell  
*RoF:* 60rpm  
*Price:* Lv4,800, Lv24 per disposable cell

*Wu-Beijing Type 1 High Energy Assault Gun:* The Type 1 was the first man-portable plasma gun to see service. Although out-classed by many newer types, it is still popular with militias and mercenary units that cannot get access to newer weaponry.

*Type:* Man-portable 10MW plasma gun  
*Country:* Manchuria  
*Length:* 137cm  
*Mass (empty):* 12kg  
*Action:* Single shot  
*Ammunition:* 12x120mm 10MW photonic core plaser cell  
*Magazine:* 4 cells in internal tubular magazine  
*Ammunition Mass:* 0.4kg per cell  
*RoF:* 40rpm  
*Price:* Lv3,900, Lv36 per disposable cell

*Kurita Arms Type 21-F:* The Kurita Type-21F is the classic second-generation man-portable plasma gun, incorporating more punch in a much more efficient design. It currently is the standard squad heavy support weapon with the Japanese Army and will probably continue in that role in the foreseeable future.

The Type-21F has been extensively exported and serves in numerous armies and some of the more prosperous mercenary operations. Sumatro-Fabrique recently concluded a license production arrangement with Kurita for the purpose of equipping the Indonesian Army.

*Type:* Man-portable 10MW plasma gun  
*Country:* Manchuria  
*Length:* 137cm  
*Mass (empty):* 12kg  
*Action:* Single shot  
*Ammunition:* 12x121mm 15MW photonic core plaser cell  
*Magazine:* 4 cells in internal tubular magazine  
*Ammunition Mass:* 0.4kg per cell  
*RoF:* 60rpm  
*Price:* Lv4,200, Lv42 per disposable cell

*Quinn-Darlan Mk 2-A2 PGMP (Plasma Gun, Man-Portable):* The result of a joint venture by Quinn Optronics, Inc. and Darlan Optophysique, the Mk 2-A2 is the heaviest of the man-portable plasma weapons now in service with American and French armed forces. It is used as a heavy point fire weapon against hard targets at the squad level. The impact of the plasma bolt can cause considerable concussion and fragmentation effects.

*Type:* Man-portable 20MW plasma gun  
*Country:* France/USA  
*Length:* 166cm  
*Mass (empty):* 12kg  
*Action:* Single shot  
*Ammunition:* 17x91mm 20MW photonic core plaser cell

*Magazine:* 10 cells in internal tubular magazine  
*Ammunition Mass:* 0.65kg per cell  
*RoF:* 40rpm  
*Price:* Lv5,400, Lv54 per disposable cell

## HEAVY PLASMA GUNS

Although less mobile, the following provide heavy firepower in more fixed locations.

*Darlan CLP1A (Cannon Legere Pyrotechnique1A) Fieldmounted Plasma Gun:* The first field mounted plasma gun to enter service, it incorporated a complex cruciform mount to allow more stable, accurate and rapid fire for a weapon of this type. Because it is virtually immobile on the battlefield, it has been withdrawn from frontline service but can often be found in fixed locations. Many CLP1 As have been exported, often as light vehicle armament upgrades. (Corresponds to Plasma A gun entry on the weapons table in the vehicle design rules, page 189).

*Type:* Field-mounted 175MW plasma gun  
*Country:* France  
*Length (Gun Tube Only):* 274cm  
*Mass (empty):* 344kg  
*Action:* Single shot  
*Magazine:* 10-cell clip fed into overhead hopper  
*Ammunition Mass:* 3.5kg per cell  
*RoF:* 30rpm  
*Price:* Lv27,900, Lv1,500 for disposable 10 cell clip

*Jaschonek Waffenfabrik A4T Plasmagewehr:* The A4T is a modification of the A4 plasma gun often found mounted in the Kz7 Combat Walker. Specifications for the two weapons are the same but the A4T is a crew-served, tripod-mounted regular infantry version. The A4T proved very effective in the German War of Reunification and has since become standard issue.

*Type:* 30MW plasma gun  
*Country:* Germany  
*Length:* 166cm  
*Mass (empty):* 20kg + 10kg tripod  
*Action:* Single shot  
*Ammunition:* 20x107mm 30MW photonic core plaser cell  
*Magazine:* 5-round box  
*Ammunition Mass:* 1kg per cell  
*RoF:* 30rpm  
*Price:* Lv16,500, Lv24 per disposable cell

## PGMPs

| Weapon    | TL | Range          | Required Skill | Damage | Magazine | Auto | Recoil | Cost    | Mass (loaded) | Ammo Cost |
|-----------|----|----------------|----------------|--------|----------|------|--------|---------|---------------|-----------|
| A-9       | 12 | Assault Weapon | Heavy Weapons  | 8d6    | 6        | No   | 3      | Lv4,800 | 6.3kg         | Lv24      |
| Type 1    | 11 | Rifle          | Heavy Weapons  | 10d6   | 4        | No   | 4      | Lv3,900 | 13.6kg        | Lv36      |
| Type 21-F | 12 | Rifle          | Heavy Weapons  | 12d6   | 4        | No   | 3      | Lv4,200 | 10.6kg        | Lv42      |
| Mk 2-A2   | 12 | Rifle          | Heavy Weapons  | 14d6   | 10       | No   | 2      | Lv5,400 | 18.5kg        | Lv54      |

## Plasma Bazookas

*Quinn M-22 Point Destruction Weapon:* Technically a field-mount weapon, the M-22 can be fired by a single gunner using the weapon's integral monopod. The weapon consists of a firing unit (Sight, trigger, monopod, containment system) and a 450 megawatt photonic core plaser cell, which is attached to the back of the firing unit. Once fired, the expended cell is removed and another put in its place. The M-22 is a close-range weapon, used for point destruction of heavy vehicles and emplacements. Care must be taken with placement of the weapon, as it generates a considerable back-blast to compensate for the weapon's enormous recoil.

*Type:* 450MW plasma gun

*Country:* USA

*Length (exclusive of plaser cell):* 168cm

*Length (with plaser cell attached):* 231cm (Size=V. Large)

*Action:* Single shot

*Ammunition:* 285x912mm 450MW photonic core plaser cell

*Magazine:* 1 cell attached to rear of weapon

*Ammunition Mass:* 16kg per cell

*RoF:* 6rpm

*Price:* Lv 7,500, Lv2,100 per disposable cell

## Flame Throwers

Flame weapons are not very effective against hard, non-flammable targets such as armoured vehicles. Against most personal armour, however, flame weapons are highly effective. Armour value is halved against these weapons in addition to the special effects listed. These comments do not apply to armour designed to resist heat attacks or sealed suits. In practice this means heatsuits, vacuum combat dress, combat walkers and vacc suits (if sealed with the helmet on) grant their full protection against flame weapons. Flame weapons are persistent. A target that is hit with such a weapon takes additional damage each round. This damage is halved each round (rounding down) until it finally runs out. A character that is flamed again while on fire takes only the largest damage of all current flame attacks – there is a limit to how much 'on fire' a person can be. The rounding down starts again from the largest damage value.

Flame Throwers are an archaic throwback, seldom used in modern warfare. On some worlds, like Aureore, they have seen use in agriculture, used to clear and sterilise land prior to the importation of terran soil and crops. After the alien invasion of Aureore, they were pressed into service as a weapon and then later for the disposal of the Kaefer bodies. Kaefer bodies apparently rapidly decompose as some sort of virulent fungus tears them apart from the inside. The fungus itself is extremely dangerous, resulting in the need to sterilise or destroy Kaefer bodies after combat.

The fuel for flamethrowers is made from hydrocarbon distillates and is usually an expensive synthetic. The thickened fuel will stick to whatever it hits and burns intensely.

The flamethrower in regular use on Aureore is adapted from the Walls Ag Pro XP4 Persistent Clearance Tool. The militarised version has a larger fuel capacity and a higher-pressure propellant tank, giving it a longer range.

*Type:* conventional flamthrower

*Country:* Texas

*Length:* 81cm

*Mass (empty):* 3kg

*Action:* Single shot or stream

*Ammunition:* Thickened hydrocarbon fuels

*Muzzle Velocity:* 80mps

*Magazine:* 40 litre backpack

*Magazine Mass:* 35kg

*RoF:* N/A

*Price:* Lv5,000 (Lv400 to refuel tank)

## NON-LETHAL WEAPONS

Sonic stunners project focused sound energy, usually in the ultrahigh frequency range, with sufficient energy to stun the target. They are only effective in atmospheres and against targets not wearing heavy armour (particularly airtight armoured helmets). As a result of these limitations and the fact that the sonic bursts merely stun an opponent, they are of limited combat value. However, they are highly effective, non-lethal control weapons and are used extensively by police and security forces. Sonic

### Heavy Plasma Guns

| Weapon | TL | Range   | Required Skill | Damage | Magazine | Auto | Recoil | Cost     | Mass (loaded) | Ammo Cost |
|--------|----|---------|----------------|--------|----------|------|--------|----------|---------------|-----------|
| CLP-1A | 11 | V. Long | Heavy Weapons  | 16d6   | 10       | No   | N/A    | Lv27,900 | 380kg         | Lv1,500   |
| A4T    | 12 | V. Long | Heavy Weapons  | 14d6   | 5        | No   | N/A    | Lv16,500 | 25kg          | Lv24      |

### Plasma Bazookas

| Weapon | TL | Range   | Required Skill | Damage | Magazine | Auto | Recoil | Cost    | Mass (loaded) | Ammo Cost |
|--------|----|---------|----------------|--------|----------|------|--------|---------|---------------|-----------|
| M-22   | 11 | V. Long | Heavy Weapons  | 16d6   | 1        | No   | 5      | Lv7,500 | 30kg          | Lv2,100   |

### Flamethrowers

| Weapon  | TL | Range   | Required Skill | Damage         | Magazine | Auto | Recoil | Cost    | Mass | Ammo Cost |
|---------|----|---------|----------------|----------------|----------|------|--------|---------|------|-----------|
| XP4 Mod | 9  | Shotgun | Heavy Weapons  | 3d6+6<br>Flame | 25       | No   | 1      | Lv5,000 | 20kg | Lv400     |

weapons can be used underwater, where they have their ranges and damages doubled and targets suffer a -1DM on Endurance Checks.

*Effect:* Sonic stunners are non-lethal and do not inflict normal damage. A character struck by a stun weapon must make an Endurance check with a negative DM equal to the damage (after armour is subtracted). If this Endurance check is failed the character is knocked unconscious. If the Endurance check is successful, the character is unaffected by the weapon and the stun damage is ignored.

*Brandt Audionique AS-3:* This sonic stunner is often found used by police and security guards. Like the P-3 laser pistol, the power pack is separate, carried on the belt beside the weapon's holster.

*Type:* Sonic stun pistol  
*Country:* France  
*Length:* 47cm  
*Mass (Empty):* 2kg  
*Action:* Single shot  
*Muzzle Velocity:* Local speed of sound  
*Magazine:* 5MJ LMS cell (40 pulses)  
*Battery Mass:* 0.5kg  
*RoF:* 130rpm  
*Price:* Lv450, Lv10 for 5 MJ disposable LMS cell

*Quinn Optronics Restraint Carbine:* The heavier restraint carbine is used for high-risk situations where its greater power over-rides its more cumbersome size.

*Type:* Sonic stun police carbine  
*Country:* America  
*Length:* 73cm  
*Mass (Empty):* 4kg  
*Action:* Single shot  
*Muzzle Velocity:* Local speed of sound  
*Magazine:* 5MJ LMS cell (15 pulses)  
*Battery Mass:* 1kg  
*RoF:* 300rpm  
*Price:* Lv600, Lv15 for 5MJ disposable LMS cell

*DunArmCo Web Caster:* The so-called 'web-gun' is a short-range device that fires a glob of sticky resin that rapidly separates out into thousands of adhesive fibres. The fibres start to harden and constrict on contact with air, rapidly cocooning their

targets. A chemical catalyst will cause the fibres to break down in about five minutes, leaving behind a sticky mess. While official correspondence calls them 'Web guns', the common street name for these devices is 'snot cannons'.

*Type:* Web gun  
*Country:* Britain  
*Length:* 83cm  
*Mass (empty):* 3kg  
*Action:* Single shot  
*Ammunition:* 27mm chemical cartridge  
*Muzzle Velocity:* 140mps  
*Magazine:* 4-round drums  
*Magazine Mass:* 1.2kg  
*RoF:* 30rpm  
*Price:* Lv1,350, Lv60 chemical cartridge, Lv15 for empty drum

## ROCKET LAUNCHERS AND MORTARS

Direct-fire rocket launchers are not in common use with most national militaries and really only find their niche with mercenary and militia units that do not have access to anything better. That being said, a rocket launcher fired at close range is a very effective tank killer, especially when fired from within the engagement envelope of any anti-missile systems.

*LAW-66:* This disposable 66 millimetre rocket launcher is not very effective against tanks but is quite capable versus light armoured vehicles and combat walkers.

*Type:* 66mm disposable rocket launcher  
*Country:* Generic  
*Length:* 40cm folded, 75cm unfolded  
*Action:* single shot  
*Muzzle Velocity:* 500mps  
*Magazine:* single-shot  
*Mass:* 3.2kg loaded  
*Price:* Lv600

*60mm Mortar:* The standard infantry mortar is a box-fed, three shot 60 millimetre mortar. A typical mortar team consists of two soldiers, one carrying the tube and base plate and the other one with three magazines for the weapon. Setup time is very quick, less than a couple of minutes and changing a magazine only

### Non-Lethal Weapons

| Weapon            | TL | Range   | Required Skill | Damage  | Magazine | Auto | Recoil | Cost    | Mass (loaded) | Ammo Cost |
|-------------------|----|---------|----------------|---------|----------|------|--------|---------|---------------|-----------|
| AS-3              | 10 | Pistol  | Energy Weapons | 2d6+2   | 40       | 0    | 0      | Lv450   | 2 kg          | Lv10      |
| Restraint Carbine | 10 | Shotgun | Energy Weapons | 3d6+2   | 15       | 2    | 0      | Lv600   | 5 kg          | Lv15      |
| Web Caster        | 11 | Pistol  | Heavy Weapons  | Special | 4        | No   | 2      | Lv1,350 | 4.2kg         | Lv60      |

takes a Standard Action. Due to the threat of counter-battery fire, these weapons can be operated remotely using an included controller with 100 metres of fibre-optic cable. It can also be connected to an Artillery computer for remote operation. Standard rounds for the mortar are High Explosive, Smoke and Flare.

*Type:* 60mm mortar  
*Country:* Generic  
*Length:* 55cm  
*Mass:* 5kg tube, 6kg baseplate, 3kg bipod  
*Action:* single shot  
*Muzzle Velocity:* 500mps  
*Magazine:* 3  
*Ammunition Mass:* 6kg per loaded 3-round magazine  
*RoF:* 1rpm  
*Price:* Lv1,500

| Round   | Base Damage | Blast Radius | Mass* | Price* |
|---------|-------------|--------------|-------|--------|
| HE/Frag | 7d6         | 5m           | 2kg   | Lv25   |
| Smoke   | —           | 10m          | 2kg   | Lv40   |
| Flare   | —           | 24m          | 2kg   | Lv30   |

\* per round.

## GRENADE LAUNCHERS

A variety of 30 millimetre grenade launchers are currently found mounted integral to most combat rifles. All of these grenade launchers are roughly similar in performance. In addition, a few older magazine-loading grenade launchers are also available, although they are seldom used now by first-line troops. Listed are grenade launchers and propelled grenades that are currently in use. All modern grenade launchers can mount rangefinder sights, which, when used with fused grenades, allow the round to be detonated at a set range, allowing such tactics as air-bursting over a trench or in the middle of a room.

*Combat Rifle Integral Grenade Launcher:* This weapon is normally encountered as part of another weapon system, such as the AS-89. Mass and cost listed are for a launcher added to a rifle.

*Type:* 30mm grenade launcher (integral to rifle)  
*Country:* Generic

## Rocket Launchers and Mortars

| Weapon       | TL | Range | Required Skill | Damage | Magazine | Auto | Recoil | Cost    | Mass  | Ammo Cost |
|--------------|----|-------|----------------|--------|----------|------|--------|---------|-------|-----------|
| LAW-66       | 9  | Rifle | Heavy Weapons  | 7d6 AP | 1        | No   | 0      | Lv600   | 3.2kg | N/A       |
| Light Mortar | 10 | Rifle | Heavy Weapons  | Varies | 3        | No   | N/A    | Lv1,500 | 20 kg | Varies    |

## Grenade Launchers

| Weapon                | TL | Range | Required Skill | Damage | Magazine | Auto | Recoil | Cost    | Mass (loaded) | Ammo Cost |
|-----------------------|----|-------|----------------|--------|----------|------|--------|---------|---------------|-----------|
| 30mm Grenade launcher | 9  | Rifle | Heavy Weapons  | Varies | 3        | No   | 1      | N/A     | N/A           | Varies    |
| GW-12                 | 10 | Rifle | Heavy Weapons  | Varies | 6        | No   | 2      | Lv1,200 | 3.2kg         | Varies    |

*Length:* N/A  
*Action:* Single shot  
*Ammunition:* Any 30mm propelled grenade  
*Muzzle Velocity:* 400mps  
*Magazine:* 3-round internal tubular magazine  
*RoF:* 120rpm

*Rortmann GW12 Grenade Launcher:* The GW12 (Granatenwerfer12) grenade launcher is typical of several of the older models of magazine fed grenade launchers that are seldom found on the frontline. It is equipped with a folding stock but if fired without the stock it suffers a -2 DM on to hit rolls

*Type:* 30mm grenade launcher  
*Country:* Germany  
*Length:* 80cm  
*Action:* Single shot  
*Mass (empty):* 3.2kg  
*Ammunition:* Any 30mm propelled grenade  
*Muzzle Velocity:* 400mps  
*Magazine:* 6-round box magazine  
*Magazine Mass:* 1.8kg  
*RoF:* 1rpm  
*Range:* 100m  
*Damage:* Dependent on grenade used  
*Price:* Lv1,200

## PROPELLED GRENADES

The following propelled grenades are suitable for use with the grenade launchers listed. For double the listed price, the grenades can be equipped with fuses that can receive ranging information from a gun-mounted sight. The usefulness of this is explained under Sights.

| Grenade   | Damage   | Blast Radius | Mass   | Price |
|-----------|----------|--------------|--------|-------|
| HE        | 6d6      | 6m           | 0.4 kg | Lv24  |
| HEAP      | 6d6 AP   | 3m           | 0.4 kg | Lv30  |
| Flechette | 3d6      | —            | 0.4 kg | Lv30  |
| Smoke     | —        | 6m           | 0.4 kg | Lv42  |
| Baton     | 2d6 stun | —            | 0.5 kg | Lv27  |

*30mm High Explosive Propelled Grenade:* Standard anti-personnel round.

*30mm High Explosive Armour Piercing Propelled Grenade:* A light anti-armour round.

*30mm Flechette Propelled Grenade:* This round turns the grenade launcher into a giant shotgun, firing fin-stabilised darts. The projectiles have a base range equal to five times the burst radius of the weapon. Within this distance they deliver an Area Fire attack against all targets. Anyone on a line from the gun's muzzle to the aim point or within the weapon's burst radius each side of it, is subject to this attack. If hit they suffer the weapon's base damage.

*30mm Concealment Propelled Grenade:* Creates a thick obscuration cloud which blocks visual and thermal images for four minutes.

*30mm Beanbag Round:* A so-called 'less-lethal' round that fires a shot-filled beanbag.

*30mm Baton Round:* Another 'less-lethal' round, this one fires a hard rubber baton that spreads into an X-shape after it is fired.

*30mm Splash Round:* This round is loaded with a volatile liquid and is often used in microgravity and spacecraft environments due to its lack of penetrative capability.

## HAND GRENADES

The following examples are representative of the common range of grenade types which are available.

*High Explosive Fragmentation Grenade:* Explosive grenade with concussive and fragmentation effects.

*Concussion Grenade:* Explosive grenade with a non-fragmenting case.

*Smoke Grenade:* Visual and IR-blocking smoke grenade.

*Flash-Bang Grenade:* Produces an extremely loud sound and a series of highly intense flashes causing disorientation and nausea. Any targets in the blast radius must make a Difficult Endurance check or have a -2 DM to all actions for 2d6 rounds due to a combination of flash blindness and disorientation from the noise. Those with proper Protection are unaffected. If the save is passed, the all characters in the target area are at -1 to all actions for 1d6-2 rounds. Targets in the second blast radius add +2 to their saves. Targets outside the second blast radius are unaffected.

### Hand Grenades

| Round      | Damage    | Blast Radius | Range Increment | Mass   | Price |
|------------|-----------|--------------|-----------------|--------|-------|
| HE         | 6d6       | 6m           | 6m              | 0.3 kg | Lv10  |
| Concussion | 6d6 stunn | 3m           | 3m              | 0.2 kg | Lv10  |
| Smoke      | —         | 6m           | 3m              | 0.3 kg | Lv20  |
| Flash-Bang | —         | 6m           | 3m              | 0.3 kg | Lv30  |

## PENTAPOD WEAPONS

The Pentapods manufacture a variety of constructs that can be used as weapons. All are illegal items in human space but there is a brisk black market trade in them. Trying to smuggle one of these artefacts to Earth would typically result in a cortex hack and brainwipe as punishment.

These weapons have become a sort of signature with several criminal gangs on Beta Canum, Kimanjano and Nibelungen.

*Tooth Gun:* The tooth gun is a living creature that manufactures both its propellant and its own ammunition. The rounds fired resemble nothing so much as large, straight predatory fangs and are coated with a material very much like the enamel in the teeth of terrestrial animals. The tooth gun can hold up to 13 rounds of 'teeth' at a time and can store enough binary propellant to fire the gun 20 times. If provided access to food, the Tooth Gun can make bullets at the rate of between one and two per hour and produce enough gas in that time to fire 10 shots.

*Spore Whip:* The spore whip is a long cord of muscle and sinew under a tough, scaly skin. It is barely alive and must be fed a special paste through an opening in the handle. Aside from the 30 centimetres of the handle, the rest of the three metre length of the spore whip is lined with dozens of small pores, each of which has a small, hollow claw or thorn in it. When the whip contacts a target, the hollow thorns inject a mix of spores into the target. The effect of the spores is chosen by the wielder but includes Injure, Stun and Loyalty. Injure causes 1d6 damage per round for 1d6 rounds. Stun causes 3d6 stun damage and lasts for 3d6 rounds. Loyalty requires a Difficult Endurance check or else the target becomes very open to suggestion.

*Strangler:* The strangler is a short, compact, gun-like object. Each strangler contains three squid-like creatures that it can expel at short range. These squids are smart enough to aim themselves for the face and neck of humanoid creatures when fired. If the squid hits, it will attempt to smother and strangle the target, doing 2d6 point of damage per round until the target is dead or the squid removed. Once all three squids are fired the strangler dies.

Given the extreme physiological difference between humans and Pentapods, the strangler must have been created specifically for use against humans.

*Biolaser:* The organic batteries of this creature only hold enough power for three shots and then it must be recharged with a



combination of the organic chemical Coumadin (Warfarin or rat poison), high-sugar food and sunlight for six hours. However, the weapon is almost undetectable and can be hidden quite easily. It is also biochemically neutral, so it can be implanted without rejection risks.

## GUIDED ORDNANCE

Virtually every major power produces a variety of guided ordnance. These weapons incorporate various means to make midcourse changes while on the way to their targets (for example: movable fins and vectored thrust). A representative selection of man-portable weapons from the arsenals of France and Germany is presented here. Weapons with Selectable or Overhead Attack angles can attack vehicles from the top or rear, where armour protection tends to be lighter.

Smart Weapons hit on a roll of 8+. The listed DM can be added to the roll. A Heavy Weapons 'To Hit' roll is required to lock the target.

*Guiscard Martel:* Firing a silhouette-homing missile, the Martel is fairly effective against targets that have been downloaded to its internal memory. Against new threats, however, the weapon loses the To Hit bonus.

*Type:* Hand-carried light air defence missile  
*Country:* France  
*Guidance:* Automatic following gunner lockon  
*To Hit DM:* +2  
*Attack Angle:* Direct  
*Launcher Mass:* 6kg  
*Missile Mass:* 2kg  
*Launcher Price:* Lv2,000  
*Missile Price:* Lv8,000

*Guiscard Antichar-14:* The Antichar-14 fires a light SEFOP (Self Forging Penetrator) warhead designed to defeat heavy armour.

*Type:* Handcarried light anti-vehicle missile  
*Country:* France  
*Guidance:* Automatic following gunner lock-on  
*To Hit DM:* +2  
*Attack Angle:* Selectable  
*Launcher Mass:* 12kg  
*Missile Mass:* 3kg  
*Launcher Price:* Lv9,000  
*Missile Price:* Lv6,000

*Jaschonek Panzerfaust 93:* In contrast to the Antichar-14, the Panzerfaust 93 fires an explosive warhead, using a binary-explosive mixture that is considerably more powerful than a conventional warhead of the same size.

*Type:* Handcarried anti-vehicle missile  
*Country:* Germany  
*Range:* 1000m  
*Guidance:* Automatic following gunner lockon  
*To Hit DM:* +1  
*Attack Angle:* Selectable  
*Launcher Mass:* 12kg  
*Missile Mass:* 11kg  
*Launcher Price:* Lv9,000  
*Missile Price:* Lv9,000

*Jaschonek Hornisse-4:* Using a smart targeting system, the Hornisse is more effective than its French counterpart at targeting unknown aircraft.

*Type:* Man-carried light air defence missile  
*Country:* Germany  
*Range:* 2,400m  
*Guidance:* Automatic or automatic following gunner lockon  
*To Hit DM:* +2  
*Attack Angle:* Direct  
*Launcher Mass:* 6kg  
*Missile Mass:* 17kg  
*Launcher Price:* Lv6,000  
*Missile Price:* Lv21,000

### Pentapod Weapons

| Weapon     | TL | Range   | Required Skill | Damage    | Magazine | Auto | Recoil | Cost (Lv) | Mass   | Ammo Cost (Lv) |
|------------|----|---------|----------------|-----------|----------|------|--------|-----------|--------|----------------|
| Tooth Gun  | —  | Pistol  | Gun Combat     | 2d6       | 13       | 2    | 0      | 5,000     | 1.2 kg | N/A            |
| Spore Whip | —  | Melee   | Melee          | Special   | —        | —    | —      | —         | 2 kg   | N/A            |
| Strangler  | —  | Shotgun | Gun Combat     | 2d6/round | 3        | No   | 1      | 7,000     | 3.4 kg | N/A            |
| Biolaser   | —  | Pistol  | Energy Pistol  | 3d6       | 3        | No   | 0      | 12,000    | 0.9 kg | N/A            |

### Guided Ordnance

| Weapon      | TL | Range | Required Skill | Damage       | Magazine | Auto | Recoil | Cost    | Mass  | Ammo Cost |
|-------------|----|-------|----------------|--------------|----------|------|--------|---------|-------|-----------|
| Martel      | 12 | 10km  | Heavy Weapons  | 7d6          | 1        | No   | 1      | Lv2,000 | 8kg   | Lv8,000   |
| Antichar-14 | 12 | Rifle | Heavy Weapons  | 8d6 Super AP | 1        | No   | 0      | Lv9,000 | 3.2kg | Lv6,000   |
| Panzerfaust | 12 | Rifle | Heavy Weapons  | 9d6 Super AP | 1        | No   | 0      | Lv9,000 | 23kg  | Lv9,000   |
| Hornisse    | 11 | 12km  | Heavy Weapons  | 9d6          | 1        | No   | 0      | Lv6,000 | 23kg  | Lv21,000  |

# WEAPON ACCESSORIES

**Laser Designator:** The laser designator is a small, flashlight-sized accessory for any rifle that allows it to be used as a laser designator for missiles and artillery. It has to be held on-target until the missile or artillery round arrives. This requires a To-Hit Roll every round, with all rounds after the first gaining a +2 DM on the To Hit roll.

**Mass:** 0.5kg  
**Range:** 400m  
**Price:** Lv950

**Laser Body Pack:** The laser body pack is a power system designed to connect a laser rifle to multiple power packs located on the wearer's load-bearing gear. The load-bearing gear can hold up to 10 power-packs for the weapon and connects to the laser weapon with a long, auto-retracting power cable that plugs into the location on the weapon where a power-pack would normally go. This rig alleviates one of the biggest problems with battlefield lasers and that the low number of shots each weapon gets. The connecting module is specific to each weapon and is not interchangeable.

**TL:** 10  
**Mass:** 1.2 kg, + weight of power packs  
**Price:** Lv350, + cost of power packs

## Sights

There are a variety of sights available for modern rifles and pistols.

**Laser Sight:** The laser sight is a small laser attached to the weapon allowing rapid and more accurate target acquisition. It grants a +1 to hit, at all ranges if combined with a telescopic sight, otherwise only at Close range.

**TL:** 8  
**Mass:** 0.1kg  
**Price:** Lv75

**Red-dot:** The red-dot sight uses a small, non-magnifying scope on top of the weapon with a large lens area. The sight projects a red dot in the centre of the sight, giving the same benefits as the laser sight without telling everyone where you are. Grants a +1 to hit but only up to Medium Range.

**TL:** 8  
**Mass:** 0.12kg  
**Price:** Lv60

## CUSTOMIZED Sights

The items listed are all options that can be combined into a scope. Rifle scopes can have all the options listed, while pistol scopes can only have one. All rifle scopes incorporate a red dot sight that can be turned on and off as needed.

**Telescopic Sight:** This is the base sight. It modifies the range band to allow the weapon to fire into the listed range band, even if it would be otherwise unable to do so.

**Pistol**  
**TL:** 8  
**Mass:** 0.1kg  
**Price:** Lv300  
**Maximum Range:** Long

**Rifle**  
**TL:** 8  
**Mass:** 0.25kg  
**Price:** Lv800  
**Maximum Range:** V. Long

**Sniper Rifle**  
**TL:** 8  
**Mass:** 0.75kg  
**Price:** Lv1,200  
**Maximum Range:** Distant

## Add-Ons

Add-on are also available as stand-alone scopes, with no other options for Lv100 more.

**Imaging:** The imaging option turns the sight into a camera and feed the image to a HUD or other imaging device. This allows the soldier to shoot around corners or use the weapon as a periscope, while only exposing his hand.

**TL:** 9  
**Mass:** +0.1kg  
**Price:** +Lv200

**Rangefinding and Fusing:** The rangefinding and fusing scope reads exact distance to the target and feeds the range information to propelled-grenades, which can then explode over a target, inside a room, whatever. In game terms, the rangefinding and fusing scope gives a +2 to hit with compatible propelled grenades.

**TL:** 9  
**Mass:** +0.2kg  
**Price:** +Lv600

**Low-light:** This allows the shooter to see in near total darkness. Negates all penalties for darkness.

**TL:** 7  
**Mass:** +0.1kg  
**Price:** +Lv400

**Thermal Imaging:** Using thermal imaging, it is possible to see (and shoot) through walls. Any wall less than 20 centimetres thick allows sufficient thermal radiation through for the imager. Negates cover bonuses for the target and allows Recon skill checks to be made through wall, although with a -2 DM. The cover would still grant a bonus to the target's Protection for damage reduction purposes only.

**TL:** 7  
**Mass:** +0.15kg  
**Price:** +Lv500

# PERSONAL ARMOUR

In many lines of work in 2300AD, body armour is extremely important. It may be all that stands between a character and a sudden, nasty death. There are two basic classifications of armour, civilian and military. The military armours are also widely used by police forces, when necessary. Civilian armour is usually designed to be worn under regular clothing or be able to pass itself off as regular clothing. Military armour has no such pretensions and it is obvious what it is.

All armours incorporate memory-plastic flaps and vents to promote comfort, yet can be sealed almost instantly in the case of a fire fight.

## ARMOUR MATERIALS

There are three different types of body armour: non-rigid, rigid and inertial. Non-rigid armour is made of flexible material which is tough and resists puncture by a bullet or energy beam. It does not inhibit the wearer's movement as much as rigid armour does. Rigid armour is made of solid pieces of ceramic-metal composite that resist blunt trauma and piercing attacks equally well. Inertial armour is flexible like non-rigid armour but becomes rigid when struck by a fast moving projectile (such as a bullet or a piece of shrapnel).

In practical terms, non-rigid armour has only half its armour rating versus distributed blows, like blunt weapons and falls, while inertial and rigid armour have their full value. In addition, non-rigid and inertial armours are not as effective versus bladed weapons, losing one point of armour against any knife or sword attack.

Several rules govern the use of armour in 2300AD. Torso-only armour can be stacked with body-suits. Body suits cannot be stacked with other body suits. Except as noted, stacked armour always has a -1 DM to all tasks, due to the cumbersome nature of it. This is in addition to any Armour Check Penalties an armour may have.

Other armours have the 'Armour Check Penalty' which is a DM on all actions. The Protection rating of the torso armours is halved and then added to the Protection rating of the body suits.

## Civilian Armour

**Protective Vest:** This is a standard 'bullet-proof' vest that can be easily concealed under most normal clothing. A Formidable Investigate or Recon check would be required to spot it.

*Country:* Generic

*TL:* 10

*Mass:* 1kg

*Protection:* 3 (Non-rigid)

*Armour Check Penalty:* 0

*Price:* Lv120

**Armoured Jacket:** Although it appears to be a normal  $\frac{3}{4}$  length jacket, close examination of this armour may reveal its true nature. Formidable Investigate or Recon Check.

*Country:* Generic

*TL:* 9

*Mass:* 2 kg

*Protection:* 4 (Non-Rigid)

*Armour Check Penalty:* 0

*Price:* Lv180

**Armoured Long Coat:** This long, heavy coat resembles a drover's coat or heavy trench coat. Close examination may reveal its true nature. (Spot vs. DC 20)

*Country:* Generic

*Type:* Medium Armour

*TL:* 9

*Mass:* 4kg

*Protection:* 5 (Non-Rigid)

*Armour Check Penalty:* -1

*Price:* Lv450

## Military Armour

### HELMETS

Most helmets incorporate communications systems and many have HUD systems and vision enhancements built-in as well. The prices and weights are for a standard helmet with a built-in 5 kilometre range radio.

A helmet worn alone provides no Protection. However, when worn with other armour it adds its full value to the overall Protection.

**Helmet:** This item is made of moulded composite materials and is standard issue for most forces.

*Country:* Generic

*Type:* Medium Armour

*TL:* 7

*Mass:* 0.5kg

*Protection:* +3 (Rigid)

*Armour Check Penalty:* None

*Price:* Lv85

**High Threat Combat Helmet:** The high-threat combat helmet is the best protection available for the head. It is normally equipped with mounting brackets for optional add-ons. It is found only in first-line units in the more advanced militaries.

*Country:* Generic

*Type:* Heavy Armour

*TL:* 10

*Mass:* 1kg

*Area Protected:* Head

*Protection:* +4 (Rigid)

*Armour Check Penalty:* None

*Price:* Lv120

**Steel Helmet:** The old-fashioned 'Steel pot,' now in service only with colonial militias and small mercenary groups because of its low price and ease of manufacture.

*Country:* Generic (primitive)

*Type:* Medium Armour

*TL:* 4

*Mass:* 2 kg

## LAW AND BODY ARMOUR

Generally speaking, body armour is almost as controlled as weapons. Most nations require a permit to own body armour, although these rules are considerably more relaxed on the Frontier. In general, civilian body armour is controlled at a Law Level of 10-Protection of the armour, while military body armour is controlled at a Law Level of 8-Protection of armour.

*Protection:* +2 (Rigid)  
*Armour Check Penalty:* None  
*Price:* Lv25

## HELMET ADD-ONS

All of these helmet add-ons can be combined with one another and can be mounted on either the standard helmet, the high-threat helmet or on a battlesuit.

*Full-Face Visor:* Constructed from transparent diamondoid material on a clear synthetic back, the faceplate is hardened to stop bullets and shrapnel and includes an auto-darkening feature to protect the wearer from flash effects, including blinding lasers. Due to the way it constricts the wearer's field-of-view, all visual Recon skill checks have a -1 DM.

*TL:* 11  
*Protection:* 7  
*Mass:* 0.2kg  
*Price:* Lv250

*HUD System:* The HUD (Heads-Up-Display) puts data and images on a reticle right in front of the user's eyes. The HUD can be coupled to the electronic sights on a weapon, giving range and wind information and provides a +2 bonus to hit. It can also be used with some sights to shoot around corners while only exposing the firing hand to return fire.

*TL:* 11  
*Mass:* 0.3kg  
*Price:* Lv400

*Low-light Imaging:* This option allows the wearer to negate all penalties related to poor lighting, as long as there is some sort of light.

*Mass:* 0.1kg  
*Price:* Lv250

*Thermal Imaging:* This option allows the user to see heat sources, which are colour-coded by the microprocessor in the overlay to go from blue (cold) to white (hot). This sight negates cover penalties for spotting and even allows Recon skill checks (with a -2 DM) to be made for completely concealed objects, so long as they radiate heat and the obstacle is no more than 20 centimetres thick.

*Mass:* 0.1kg  
*Price:* Lv350

*Tactical Camera:* The tactical camera is more often found with law enforcement than with regular military, as the need to document their actions is more a function of the former than the latter. The tactical camera is designed to both record internally and to narrowcast what it sees back to a command centre. Both recordings have to match in order for the video to be admissible in court. The camera has a narrowcast range of 500 metres and can store six hours of high-resolution video and audio internally.

*Mass:* 0.1kg  
*Price:* Lv80

## HUDs AND SIGHTS

A HUD can make use of the options on a weapon's sight.

## Military Armour

*Full-body Non-rigid Armour:* This is a set of armoured coveralls.

*Country:* Generic  
*TL:* 7  
*Mass:* 10 kg  
*Protection:* 5 (Non-rigid)  
*Armour Check Penalty:* -2  
*Price:* Lv900

*Full-body Inertial Armour:*

*Country:* Generic  
*TL:* 10  
*Mass:* 10kg  
*Protection:* 5 (Inertial)  
*Armour Check Penalty:* -2  
*Price:* Lv1,800

*Full-body Rigid Armour:* Although the protection is similar to a battlesuit, it lacks the cooking layer and other enhancements and so is very fatiguing to wear.

*Country:* Generic  
*TL:* 10  
*Mass:* 10kg  
*Protection:* 8 (Rigid)  
*Armour Check Penalty:* -3  
*Price:* Lv3,500

*Vedette Half Armour:* The vedette half-armour is a rigid ceramic/alloy plate designed to protect the chest and shoulders. Variations on this theme are found throughout human space. This armour uses special stacking rules. It can be stacked with any non-rigid or inertial torso or full body armour.

*Country:* France  
*Type:* Medium Armour  
*TL:* 9  
*Mass:* 2kg  
*Protection:* +2 (Rigid)  
*Armour Check Penalty:* None  
*Price:* Lv1,200

**Rigid Breastplate:** This heavy front-and-back armour is the best available for non-battlesuit troops and is usually combined with inertial full-body armour for maximum Protection. Most soldiers dislike the armour as heavy and awkward. It can also be worn by itself.

*Country:* Generic

*Type:* Heavy Armour

*TL:* 10

*Mass:* 8kg

*Area Protected:* Chest and Torso

*Protection:* 10 (Rigid)

*Armour Check Penalty:* -2

*Price:* Lv2,000

**Non-rigid Vest:** This long vest is not concealable and incorporates additional padding and thicker armour than its civilian counterpart. It can be layered or worn alone.

*Country:* Generic

*Type:* Medium Armour

*TL:* 7

*Mass:* 2kg

*Protection:* 5 (Non-rigid)

*Armour Check Penalty:* -1

*Price:* Lv500

**Inertial Armour Vest:** This long vest is not concealable and incorporates additional padding and thicker armour than its civilian counterpart.

*Country:* Generic

*Type:* Medium Armour

*TL:* 10

*Mass:* 3 kg

*Protection:* 5 (Inertial)

*Armour Check Penalty:* -1

*Price:* Lv750

## **SPECIAL ARMOURS**

**Battlesuit:** A battlesuit is a combination of full-body rigid armour, breastplate and high-threat combat helmet, along with a pair of armoured boots, mated to an undergarment that provides cooling and additional protection for the joints. This undergarment also provides a databus to connect weapons and accessories to helmet HUDs and under-armour power packs. Full life support is provided for four hours through a built-in system, although the battlesuit is not rated for combat in vacuum. The only drawback to the battlesuit is that they are fatiguing to wear and combat effectiveness is only a few hours at best. These suits are not powered and the heavy armour takes its toll after time, even with the cooling layer. Up to four laser power packs can be carried under the armour and connected to a weapon via a cable similar to the laser body-pack.

*Country:* Generic

*TL:* 12

*Mass:* 32kg

*Protection:* 12 (Rigid)

*Armour Check Penalty:* -2

*Price:* Lv12,000, plus cost of accessories and electronics

**Explosive Ordnance Disposal (EOD) Armour:** While most explosive disposal is done by robots, there often comes a time when a human expert has to get involved. When this happens, the heavy EOD armour is brought into play. A suit of EOD armour has better protection than a battlesuit, everywhere except the hands. They are only lightly protected, allowing the EOD tech a fine sense of touch to assist in disabling the device. Camera are mounted on the arms and helmet both, giving the tech a close look at what they are doing while protecting the head with the heavy armour.

*Country:* Generic

*TL:* 12

*Mass:* 40kg

*Protection:* 18 (Rigid)

*Armour Check Penalty:* -3 (except for hand-only actions)

*Price:* Lv12,000, plus cost of accessories and electronics

**Combat Vacuum Suit (CVS):** Developed for use in boarding actions and other combat in a vacuum environment. The suit is designed with a limited self-sealing system that consists of an inner gel layer that hardens on exposure to air or vacuum. This system can only handle small breaches, such as those made by small-calibre weapons. Heavy weapons and plasma guns are too much for the self-sealing system to handle (Can repair 2d6 points of damage per round, to a maximum of 30 points). It includes a Long-range radio.

*Country:* Generic

*Type:* Medium Armour and Vac Suit

*TL:* 11

*Mass:* 14kg + Life support

*Protection:* 10 (Rigid)

*Armour Check Penalty:* -2

*Price:* Lv8,000, plus cost of accessories and electronics

**Military Life Support Pack:** Military Life-Support Packs are manufactured in two varieties; short duration and long duration. The shorter duration of these systems compared to civilian systems is due in large part to the increased cooling demands of military suits and equipment.

Short-Duration packs cannot add oxygen bottles and have the following characteristics:

*Mass:* 2kg

*Duration:* 4 hours

*Protection:* 8

*Price:* Lv2,000

Long-Duration Packs can have additional oxygen bottles added to them to extend their operating range. Additional bottles cost Lv50, weigh 1 kilograms and add six hours to the suit's duration. There is room in the Long Duration Pack for two additional bottles.

*Mass:* 8kg

*Duration:* 12 hours

*Protection:* 10

*Price:* Lv10,000

# ROBOTS AND DRONES

Robots are very common in the society of 2300AD. Robotic systems can be found almost anywhere, from the automated surveillance drones that wander the streets of the Core cities, to the mining equipment used on remote colonies, to cleaning and service 'bots found in many homes almost everywhere. Robots in 2300AD are defined as machines that can follow a set of guidelines without human supervision or intervention. These machines have a limited learning capacity as well, allowing them to remember solutions and implement them in similar situations. They are not capable of thinking but can simulate intelligence if skillfully programmed.

Drones are simply remote-controlled vehicles, requiring almost constant operation and supervision. Many robots also have a remote-control facility, however, blurring the lines between the two. Typically, a robot can be remote-operated but a drone has no self-guiding capability and is thus considerably cheaper than a robot.

## **Domestic Robot**

The Home Companion is an all-purpose bipedal robot, designed to handle any routine domestic duty. While they cannot really cook, they can microwave prepared food and can follow directions to cook simple meals. They are intended to provide cleaning and upkeep services. The small (110 centimetre tall) robots have a limited vocabulary and are quite capable of holding a conversation or even playing some games (chess, backgammon and others). They come with all cleaning attachments built-in and simply need to recharge from a wall socket every so often. They are very popular with spacecraft crews and in space habitats of all sorts.

Strength 10, Dexterity 12, Hull 3, Structure 2  
Intelligence 7, Education 7

*Traits:* Parallel Computer with 2,000GB, running Control Algorithm 2, Personality Program 2, Antivirus 1, Steward 0, VRS, Encyclopedia 2

*Equipment:* Household Cleaner, Audio Sensors, Code Reader, Motion Sensor, Basic Optics, Smoke Detector, Tactile Sensor, Wireless Connection

*Weapons:* Robot Punch (Melee (unarmed), 1d6 damage)  
*Price:* Lv45,700

## **Sortech FE-909 Security Robot**

The FE-909 is a small wheeled unit designed to provide perimeter patrol for a large compound. Equally suitable for indoor or outdoor work, the FE-909 comes equipped with low-light and infrared vision, along with a powerful spotlight and a set of rotating red flashers and a siren. By law, these robots cannot be armed but many facilities on the Frontier arm them with sonic weapons or even lasers.

Strength 8, Dexterity 8, Hull 4, Structure 4  
Intelligence 7, Education 7

*Traits:* Parallel Computer with 2,000GB, running Control Algorithm 2, Personality Program 2, Antivirus 1, Security 2, VRS Audio Sensors, Infrared Sensor, Motion Sensor, Basic Optics, Smoke Detector, Wireless Connection, Loudspeaker, Light Bar, Spotlight, Fire extinguisher

*Weapons:* Robot Punch (Melee (unarmed), 1d6 damage), sonic stunner

*Price:* Lv26,000

## **Darlan UVR-3 Surveillance Drone**

The UVR-3 is a small airship-style vehicle typical of the drones used for inner-city surveillance. They are controlled by remote expert systems and are programmed to drift about on random courses. All audio and video captured by the small drone feeds to the expert system, which monitors the signals for anything suspicious. If it finds something, it alerts a human operator, who can use his controls to operate the drone and investigate more closely.

Strength 0, Dexterity 8, Hull 2, Structure 1  
Intelligence 2, Education 0

*Traits:* Parallel Computer with 2,000GB, running Control Algorithm 1, Personality Program 1, Security 1  
Audio Sensors, Lowlight Sensor, Basic Optics, Smoke Detector, Wireless Connection,

*Weapons:* None

*Price:* Lv5,800

## **Pinchot Industries AR-201 Construction Robot**

A common sight throughout the Core and the more advanced worlds of the Frontier, construction robots like the AR-201 perform a myriad of tasks, from excavation and road building to

building construction and renovation. These modular robots can be equipped with several attachments and larger models are used for truly massive engineering tasks.

*Traits:* Robot Brain: Parallel Computer with 2000GB, running Control Algorithm 2, Personality Program 1, Antivirus 1, Skill Pack (construction) 2, VRS, Basic vocoder

*Equipment:* Tracked, Digging tools, One ton crane, low light, infrared, video display, lightbar, 4 spotlights,

### Recon Drone

This small remote-operated helicopter is generally unarmed, although it can be equipped with a light weapon, such as a light machinegun or automatic shotgun. The adaptive rotors render it extremely quiet and it can hover as high as 6,000 metres above a target or as close as two metres. It is only capable of rudimentary actions without a remote controller of some sort.

*Size:* 2

Strength 0, Dexterity 0, Hull 2, Structure 1

Intelligence 2, Education 0

*Traits:* Parallel Computer with 2,000GB, running Control Algorithm 1, Personality Program 1, Antivirus 1, Recon 1, VRS

*Equipment:* Audio Sensors, Advanced Optics, Infrared, Distant Transceiver,

*Weapons:* Robot Punch (Melee (unarmed), 1d6 damage)

*Price:* Lv20,400

### Surveillance Swarm

The Swarm is made up of approximately 100 large-insect-sized flying robots. The swarm has a very limited range but within that limit they are very useful. This particular swarm is a surveillance swarm, released into a building or onto a battlefield, that can rapidly gather images and intelligence from a large area. Computers back at the controller site can then assemble these images into a collective whole.

Swarms can only be damaged by area attacks, like flamethrowers and explosions. Such weapons destroy a number of swarm units equal to half their damage, round down. All other weapons will only destroy 1 swarm unit per attack, regardless of the damage inflicted.

Int 2 Speed 8 mpr *Skills:* Recon 0

*Price:* Lv23,000

| Vehicle | TL | Skill | Agility | Speed   | Range | Armour | Crew and Passengers | Cargo | Open? | Hull | Structure | Cost      | Shipping Size |
|---------|----|-------|---------|---------|-------|--------|---------------------|-------|-------|------|-----------|-----------|---------------|
| AR-201  | 11 | N/A   | -1      | 75 km/h | 75 km | 4      | N/A                 | No    | No    | 10   | 10        | Lv210,000 | 10 tons       |

# CORTEX HACKING

Psionic abilities are unknown in the world of *2300AD*, existing only in the realm of fantasy. The best anyone can do is a sensitivity to electro-magnetic fields, including the electrical fields emanated by the brain. However, there is no way for a person to interpret these signals.

However, aided by a computer system and a sensitive field pattern reader called a Sub-Quantum Interface Device (SQUID), an interrogator with a neural jack can perform cortex hacking.

Cortex hacking allows a skilled operator to enter and sift through a person's mind. Although the target does not have to have a neural jack themselves, it does make the interrogator's task easier. In any case, the subject has to be immobilised in the SQUID, while the interrogator is connected to it by a bundle of fibre optics as thick as a man's arm.

Cortex hacking uses Psychology as the primary skill by itself, reinforced by the computer operator. It is also an Opposed task, with the target able to use his Intelligence stat, plus any skill in Psychology, to try and thwart his interrogator. Drugs can be used to assist the hacking process but too much will render the brain unreadable, too confused and muddled.

Cortex-hacking uses a modified version of the *Traveller* rules for Psionics.

## **The Cortescan 3000 TL 12**

At the heart of Cortex-Hacking is the SQUID and associated hardware that allows a sensitive to read the thoughts of another. The Cortescan itself consists of two beds, a computer and the scanning helmets and electrodes that are attached to each subject. The computer creates a gateway, so that any scanning is strictly one-way.

The Cortescan requires two people for operation. One is a computer specialist with a medical background to operate the machine itself. The other is the Cortex-hacker, a person with EM sensitivity (Trait) plus considerable skill in Psychology.

*Power:* 6

*Mass:* 500kg

*Cost:* Lv1.5 million

A Cortescan 3000 does not include the required resonance imager but one can be found in most hospitals at TL 10 or above.

The process is fairly complex.

The first step is to use a resonance imager to map the subject's brain. The information gained allows the SQUID to be calibrated properly to the subject, as everyone is slightly different. If the sensitive is new, then their brain needs to be mapped as well.

### *Using the resonance imager to map a subject brain*

Difficult, Medic, Edu

The Effect from this roll is added to the initial roll to synchronise the Cortescan with the subject.

The next step is to synchronise the subjects with the Cortescan.

### *Synchronise subject with Cortescan*

Formidable, Computer, Edu (Medic of +2 or better required as an enabling skill). The Effect roll from the resonance mapping is used as a DM for this check.

Once the minds are synchronised, the interrogator can get to work.

The skill used in cortex hacking is Psychology, rather than any psionic ability. However, the skill of the computer operator also factors in. The skill level of the operator is used as the base Power Points available to the sensitive each turn. The Cortescan device itself also has a reserve of energy that can be used in the process. However, this energy is only available once per session.

The listed *Strength* for each task is the operator's computer skill, plus whatever of the Cortescan's limited strength the psychologist chooses to use.

So, if the operator has Computer-2 and the Cortescan has six points available (start of a session), then the psychologist entering the brain of the convicted felon on the table next to them could use up to eight points.



If the subject has a cortex screen, they are immune to the cortex-hacking unless they have a neural jack, allowing them to be plugged directly into the machine. Even at that, attempts to cortex hack will suffer a -2 DM on all Psychology Tasks. Cortex screens are a cybernetic implant that prevents the head from being scanned, even with a resonance scanner.

*Other DMs*

Cortex Hacker has a neural jack: +1

Subject has a neural jack: +2

### **EMOTION SENSITIVITY**

The communication of emotions and basic feelings is accomplished by emotion sensitivity. This ability serves well in the handling of animals and beasts of burden but may also be applied as a psychological weapon against humans. Sending of emotions may influence other beings and is often used as part of psychotherapy. Emotion sensitivity also allows the emotions and feelings of others to be read by a character. The Effect of the check determines the strength of the projected emotion.

*Psychology, Strength, 10-60 seconds, Routine (+2).*

*Costs 1.*

### **READ SURFACE THOUGHTS**

The most widely known feature of Cortex-hacking is the ability to read the thoughts of other individuals. Only active, current thoughts are read by this ability. Individuals with a cortex screen cannot be read, unless the Cortescan is connected to a neural jack instead. The Effect of the check determines the clarity of the sensitive's perceptions.

*Psychology, Strength, 10-60 seconds, Average (+0).*

*Costs 2.*

### **SEND THOUGHTS**

Complementary to the ability to read surface thoughts is the ability to send thoughts to others. Such individuals need not themselves be sensitive to receive such thoughts. This is often used as part of interrogation or counselling.

*Psychology, Strength, 10-60 seconds, Difficult (-2).*

*Costs 2.*

### **PROBE**

The application of high power levels and skill will enable a cortex hacker to delve deep into the mind of a subject and to then read his innermost thoughts. Questioning can be used in the procedure to force the subject to divulge specific information. The prober can easily determine deliberate untruths told (thought) by the subject. Probe cannot be used against a shielded mind. Again, the Effect of the check determines the clarity of the telepath's perception.

*Psychology, Strength, 1-6 minutes, Very Difficult (-4).*

*Costs 4.*

### **ASSAULT**

Violence may be dealt through cortex-hacking. An unshielded mind, when assaulted through a cortescan link, is rendered unconscious immediately and the character suffers 2d6 + Effect damage. Unlike normal damage, assault damage is first applied to Endurance, then Intelligence. Endurance returns as normal (see pages 152 and 74 of the *Traveller Core Rulebook* respectively). Intelligence returns at the rate of one point per day. If Intelligence is reduced to zero, then the subject has been mind-wiped. This process can take several days. Intelligence will return but no skills or personality will follow. The Incan Republic, UAR and Canton use mind-wiping as the punishment for capital crimes.

*Psychology, Strength, 1-6 seconds, Formidable (-6).*

*Costs 8.*

### **Clarity and Effect**

How much information the Cortescan and its operators can glean from a subject's mind depends upon the level of Effect obtained.

| Level of Effect |   |
|-----------------|---|
| 0               | No Information                              |
| 1               | 5% of available information becomes known.  |
| 2               | 15% of available information becomes known. |
| 3               | 25% of available information becomes known. |
| 4               | 40% of available information becomes known. |
| 5               | 55% of available information becomes known. |
| 6               | 70% of available information becomes known. |

# VEHICLES

Vehicles travel by interacting with land, air or water. Ground vehicles interact by means of wheels, tracks, legs, rails or air cushions. Air vehicles remain aloft by means of dynamic lifting surfaces (such as rotors or airfoil wings), vectored thrust (where the engines bear the entire weight of the vehicle, without benefit of aerodynamic surfaces) or lifting envelopes filled with a gas lighter than the background atmosphere. Combinations of all of these are certainly possible. For water travel, vessels rely on air-filled hulls for buoyancy. These hulls may be designed either to travel completely submerged (as in a submarine), partially submerged or lifted from the water by hydrofoils.

On Earth and Tirane, all vehicles sold come equipped with Traffic Control (TrafCon) links, allowing them to be driven automatically. This requires only a basic (Skill/0) vehicle Autopilot system, as the network provides the rest. These vehicles are also tied into the global satellite network, for both navigation and tracking purposes. Versions sold on colony worlds usually do not have the TrafCon links, nor the tracking modules. The navigation equipment is standard everywhere, however.

An even wider variety of vehicles are produced by the factories of Earth and its colonies in the 24th Century than are available today. It would be impractical to completely catalogue them here but the following listings give a broad sample of the types of vehicles available and explain their performance capabilities.

Most vehicles are powered by hydrogen fuel cells and are effective in any environment containing oxygen, although compressor systems may be required for worlds with a low partial-pressure of oxygen. It is even possible for a vehicle to carry oxygen and so not require any externally. This will reduce the vehicle's range by 50%.

## VEHICLE RULES

### SENSOR USE

Sensors have a listed range, much like weapons. This is the maximum effective range of the sensor system. Use the DMs from the fire control chart that follows, to determine range-based DMs for spotting a target, using the Sensors skill. This is Tech Level dependent.

There are additional modifiers for target size, as noted in the following table.

### SIZE

| Hull Rating | Size DM |
|-------------|---------|
| 1–10        | +0      |
| 11–25       | +1      |
| 26–50       | +2      |
| 51–150      | +3      |
| 151+        | +4      |

### Vehicle-Mounted Weapons

| TL    | Personal     | Close | Short | Medium | Long | V. Long | Distant      | V. Distant   | Extreme      | Continental  | Orbital      |
|-------|--------------|-------|-------|--------|------|---------|--------------|--------------|--------------|--------------|--------------|
| 3–4   | Not Possible | -2    | 0     | -2     | -4   | -6      | Out of Range | Out of Range | Out of Range | Out of Range | Out of Range |
| 5–6   | Not Possible | -2    | 0     | 0      | -2   | -4      | -6           | Out of Range | Out of Range | Out of Range | Out of Range |
| 7–8   | Not Possible | -2    | 0     | 0      | 0    | -2      | -4           | -6           | Out of Range | Out of Range | Out of Range |
| 9–10  | Not Possible | -2    | 0     | 0      | 0    | 0       | -2           | -4           | -6           | Out of Range | Out of Range |
| 11–12 | Not Possible | -2    | 0     | 0      | 0    | 0       | 0            | -2           | -4           | -6           | Out of Range |
| 13–14 | Not Possible | -2    | 0     | 0      | 0    | 0       | 0            | 0            | -2           | -4           | -6           |
| 15–16 | Not Possible | -2    | 0     | 0      | 0    | 0       | 0            | 0            | 0            | -2           | -4           |

Sensors, stealth and electronic warfare, more than almost any other system, are critically defined by Tech Level. The difference in Tech Level between vehicles is used as a negative or positive DM for Sensors rolls and Electronic Warfare rolls.

A TL 11 aircraft with +3 Stealth is trying to infiltrate into an Imperial landing zone. The Imperials are TL 14 and are using Good (+1) Sensors. The TL difference of three gives the Imperials another +3 bonus on the Sensors Roll, negating the bonus due to the aircrafts Advanced Stealth. The Imperial are thus at a +1 to detect the invading aircraft.

## **FIRE CONTROL**

The ability of a vehicle-mounted weapon to hit a target is dependent on range, movement, stabilisation, fire control and several other factors. Stabilisation and Fire Control are dealt with on a TL-based Weapon Range Chart.

## **ADDITIONAL RANGE BANDS**

Vehicular weapons have ranges vastly longer than man-portable weapons and these increased range bands reflect that fact

| <b>Range Band</b> | <b>Distance</b>      |
|-------------------|----------------------|
| V. Long           | 251–500 metres       |
| Distant           | 501–5,000 metres     |
| Very Distant      | 5,001–25,000 metres  |
| Extreme           | 25,001–50,000 metres |
| Continental       | 50–500 kilometres    |
| Orbital           | 501+ kilometres      |

## **VEHICLE MOVEMENT**

On-road vs. Off-road.

The listed Movement rate for the various ground vehicles is their on-road movement. If a ground vehicle goes off-road, it suffers a –2 to Agility, Movement is reduced to 25% of normal and rough terrain cannot be crossed. Conversely, a vehicle that is off-road capable does not suffer the –2 Agility penalty, Movement is not reduced and it can cross rough terrain with a –2 Agility penalty.

Rough terrain is heavy forest, very broken ground and rock faces between 20% and 50% slopes.

## **SPECIAL FEATURES**

Most of the vehicles have a number of special features. While these are described in the Vehicles supplement, a quick explanation is also provided here.

The following features are incorporated into the vehicle data blocks already and, although noted in Special Features, need no further information.

Increased Speed, Decreased Speed, Increased Agility, Decreased Agility, Increased Structure, Decreased Structure, Increased Hull, Decreased Hull, Increased Range, Decreased Range.

## **Other Features**

**Improved Fire Control:** Improved Fire Control can represent anything from improved stabilisation to laser-rangefinders. It provides the listed DM on all attacks rolls using mounted weapons.

**Primitive Controls TL 2:** Very basic, non-powered controls.

**Basic Controls TL 4:** This is the default control set-up, with no modifiers.

**Advanced Controls TL 8:** Advanced drive-by-wire systems with heads-up displays. Adds +1 to Agility and +1 to Driver's Recon Checks

**Neural Link TL 12:** The neural link is a true mind-machine linkage and allows an operator to control the vehicle with their mind alone. This gives a +2 to Initiative and a +2 to Agility.

**Autopilot:** Autopilots are available for aircraft and sea vessels starting at TL 5 and for ground vehicles at TL 9. The listed skill level is for the autopilot. Note that the autopilot cannot add its skill to the pilot's. On Earth and Tirane, vehicles require only basic Autopilots, as they tie into the TrafCon network, which handles all the driving tasks with a Drive/3.

**Aquatic Modification:** This includes such things as a watertight hull, propellers or water-jets for propulsion and a snorkel for Heavy vehicles.

**Anti-missile systems:** Missiles, rockets and launched grenades are a significant threat to most combat vehicles, with missiles being capable of taking out the most heavily-protected vehicles.

To combat this threat, a variety of anti-missile systems have been developed. They are often used in concert.

These systems will negate an incoming missile, rocket, launched grenade or mortar round on a roll of 8+. Some systems have Target DMs that modify this and every system will suffer a –1DM for every additional target is forced to engage in each round.

**Smoke Dischargers:** Smoke dischargers render the vehicle difficult to see and target visually. This gives a –2 DM all to hit rolls. At TL 7, radar-based targeting renders smoke dischargers largely ineffective. They remain effective against laser weapons, reducing damage by 3D6 per shot.

**Flares:** Blind thermal-seeking weapons with intensely-hot flares. –2 DM on To Hit rolls for thermally-guided missiles.

**Chaff Dispensers:** Uses dozens of reflective strips to confuse radar-seeking weapons. –2 DM on To Hit rolls for all radar-guided missiles.

**Prismatic Aerosols TL 9:** Prismatic Aerosols use hundreds of fine crystal spheres, finer than sand to refract and deflect laser light. They also have the effect of attenuating laser fire to a certain amount, reducing damage by 2D6 per shot.

**Life Support, Short Term:** Life Support supplies a breathable atmosphere no matter the exterior conditions. Short term life support is good for one day, after which the vehicle's occupants suffer a -1 DM to all Skill checks. Maximum duration is four days before the system needs new air and filters.

**Life Support, Long Term:** Advanced life Support provides comfortable life support for up to 90 days. Occupants suffer no DMs for time spent in the vehicle.

**Air Lock:** One-person airlock.

**Hostile Environment Protection:** Hostile Environment Protection will safeguard the vehicle and its crew in dangerous but still at least marginally-habitable, environments. This includes protection from very hot or very cold environments, radiation, poisons and bacteriological threats.

**Vacuum Environment Protection TL 6:** Vacuum Environment Protection provides complete protection against vacuum conditions. It subsumes the benefits of Hostile Environment protection.

## ELECTRONICS

### Computers

Computers use the rules from page 92 of the Traveller Core Rulebook. Double costs for vehicular use.

### Navigation

Navigation equipment helps a vehicle's occupants find their way around. Lack of Navigation equipment simply means they have to make due with hand-held equipment and maps. Basic Nav equipment provides a +1 DM, Standard provides a +2 and Advanced provides a +3 DM

### Communications

Most communications use electromagnetic radiation, whether in the form of radio, lasers or masers.

Comm TL and Base Range

|    |             |
|----|-------------|
| 8  | Extreme     |
| 10 | Continental |

### Boosted range

Each additional range band doubles the cost of the communicator.

### Tightbeam

Tightbeam uses a laser or maser instead of a radio to precisely aim the signal so that it either cannot be intercepted or only with great difficulty.

### Satellite Uplink

This allows a communications system to communicate with a satellite or ship in orbit. It includes the necessary tracking equipment to stay locked on and is often combined with a tight-beam system.

### Encrypted

At the same Tech Level, Encrypted communications are almost Impossible to crack, requiring an Impossible skill check. Tech Level difference represents a bonus or penalty, depending on whether the reading equipment is from a higher or lower tech. So, if invading TL 12 French Legionnaires intercept a TL 9 encrypted communiqué from secessionist forces, they have a DM of +3 to decode it. If those insurgents managed to intercept an encrypted TL 12 transmission, they would be at -3 on their roll to decode it.

### Sensors

| Class    | Bonus | Range        |
|----------|-------|--------------|
| Basic    | 0     | Very Long    |
| Standard | +1    | Distant      |
| Advanced | +2    | Very Distant |

Sensors are rated within their Tech Level. The difference in Tech Levels is a negative or positive DM for Sensor rolls.

So a TL 7 Advanced Sensor (radar) is trying to get a lock on a TL 10 stealth aircraft. It has a +2 DM for having Advanced Sensors but a -2 DM for the difference in Tech Level and a further -2 for the Good Stealth on the aircraft for a total DM of -2

Conversely, a TL 12 interceptor with Basic Sensors (+0) is trying to locate a TL 9 stealth fighter. The fighter is has good Stealth, for a -2 DM. The gunship is a higher Tech Level and the difference is 3 for a further +3 DM. Total DM then is (-2+3) for a total of +1.

A TL 8 police helicopter with Standard Sensors (+1) is trying to detect a TL 12 groundcar speeding through the country-side. The groundcar has no stealth. The police vehicle has +1 for the sensor and -4 for the difference in TL, for a total DM of -3.

### Underwater Sensors

|          | Bonus | Range     |
|----------|-------|-----------|
| Basic    | +1    | Long      |
| Standard | +2    | Very Long |
| Advanced | +3    | Distant   |

Surface sensors cannot be used underwater and vice versa.

### Stealth

Stealth is the art of rendering a vehicle undetectable to sensors. Tech Level is critically important in this game between stealth and detection. The Tech Level difference between the stealth vehicle and the detecting vehicle is a DM on detection rolls,

positive if the detecting vehicle is a higher Tech Level, negative if is lower Tech Level.

The listed bonus is applied as a DM against sensors of the same Tech Level. Cost is a modifier of the base vehicle cost.

| Stealth Class | Stealth Bonus |
|---------------|---------------|
| Basic         | -1            |
| Good          | -2            |
| Advanced      | -3            |

### Camouflage

Camouflage is distinct from stealth. Stealth is all about hiding a vehicle electronically. Camouflage, however, is about hiding it visually. In this context, that includes its infrared signature. It is less dependent on Tech Level differences, although all the camouflage in the world will not help you if you can be spotted by radar.

### Infrared Masking

| IR Mask Class | TL | Bonus |
|---------------|----|-------|
| I             | 7  | +1    |
| II            | 9  | +2    |
| III           | 11 | +3    |

### Visual Camouflage

| Stealth Class | TL | Stealth Bonus |
|---------------|----|---------------|
| I             | 7  | +1            |
| II            | 11 | +2            |

### Other Modifications

**Ejection Seat TL 5:** The ejection seat takes up two Spaces and is designed to blast the occupant clear. At lower Tech Level this means a suitable height to open a parachute but at higher Tech Levels it is merely sufficient to get clear of the vehicle until a grav chute can deploy.

**Ejection Cocoon:** The cocoon is a lightly-armoured (Armour 4) shell that also provides a limited, pressurised environment. It is used in high-speed aircraft, where ejection could be very dangerous. It is also used in hostile environment situations.

**High Capacity Seating:** The normal standard of one Space per passenger or crew allows some elbow-room and limited room to move about. High-capacity seating greatly increases the seating density but take away from elbow room and room to move. High-capacity seating can be either double or triple. High-capacity seating cannot be used for troop seating or for control areas.

**Bunks:** Bunks can accommodate up to two people, take up one Space and cost Lv200.

**Galley:** A mini-galley can be used to prepare simple meal and pre-packaged food. It includes a small stove, refrigerator and microwave oven, along with some storage.

**Fresher TL 7:** A fresher, complete with toilet, sink and shower.

**General Purpose Lab TL 7:** A general purpose lab provides no bonuses but it allows tasks with no penalty for missing tools/equipment. General purpose labs are available at TL 7. They consume two Spaces per researcher using the lab and cost Lv5,000 per Space.

**Lab Space TL 9:** Lab space includes analytic equipment, computer workstations and equipment appropriate to the discipline. Each type of lab has to be purchased separately. A proper lab space grants a bonus equal to between +1 to +3 and take up one Spaces per bonus per researcher using the lab. A +3 lab, used by three researchers, would take up nine Spaces. Cost is Lv10,000 x Spaces used.

Lab types include: physics, chemistry, biology, psychology, structures and materials. Other types are possible.

### Deployment Ramps/Harnesses

Rappelling equipment and power assist. Each rig can hold up to 500kg. Lv500. No Spaces.

### EQUIPMENT AND TOOLS

**AutoDoc:** The Autodoc is a basic whole-body automated treatment system. AT TL 10, the 'doc has a med skill of 1, which increase by 1 at TL 12 and TL 14. Effective EDU for diagnostic purposes is 10, while Dex for surgical treatment is 8. The 'doc takes up two Spaces and costs Lv10,000.

**Fire Extinguishers:** Fire extinguishers are designed to put out fires internal to the vehicle. No Space, Lv500.

**Geology Equipment:** Equipment for geology skill rolls. Adds +1 to all rolls at TL 10 and +2 at TL 14.

**Digging Equipment TL 5:** Digging and scooping equipment

### Manipulators and Cargo Arms

**Manipulator Arms:** Manipulator arms are remote appendages with claws or hands. Their characteristics are listed with the vehicle description.

**Light Crane:** Light Cranes can lift up to 400 kg and can be used as rescue cranes as well.

**Medium Crane:** Medium Cranes can lift up to 2,000 kg.

**Heavy Crane:** Heavy Cranes can lift up to 10,000 kg.

**Cargo Arm:** This is a heavy-duty manipulator arm used for lifting cargo in confined spaces. Cargo arms have a base STR of 30 and a DEX of 0.

### Luxury Equipment

**Wet Bar TL 2+:** A basic wet bar, species-specific.

**Entertainment System TL 5:** This system usually includes the ability to play music, video and games. Content comes from the link network or, more rarely, from datawafers

**Refuelling Station TL 9:** The refuelling station is designed to crack water into fuel, using the sun as a power source. It requires a significant amount of space and access, to water and the sun in order to work. At TL 9, it requires Hull value x3 hours to crack sufficient fuel to completely refuel a vehicle. At TL 12 this is reduced to hull x 1 hour.

## LAND VEHICLES

Land vehicles are, of course, the most commonly used of all vehicles. They run the full range from small civilian recreational vehicles to massive construction equipment and machines of war.

## PUBLIC TRANSPORT

Most people on the Core Worlds in the 24th Century do their daily travelling by means of public transportation. Tube lines, for example, offer a smooth, comfortable ride at very high speeds. Ground cars, although not quite as fast, are just as comfortable thanks to TrafCon systems and offer added flexibility. Because of the high speeds available to the Tube trains and to TrafCon controlled vehicles, suburban areas can lie much farther from the cities they surround and those wealthy enough to live in the suburbs enjoy an added sense of security with the increased distance. Ground cars are more often used by those living closer to the city or people who need (or just want) the increased flexibility. Out in the Frontier, however, public transportation is typically not very well-developed, even in the more urbanised areas.

# CIVILIAN VEHICLES

**Street Monowheel** (Light Ground Vehicle, 1 Space): The monowheel is a favourite with young people looking for a fast, impractical vehicle. These small vehicles can be found throughout urban areas of the Core and even on the streets of the more developed Frontier worlds. It is next to useless off-road, however. When the speed drops below 10 kilometres per hour, a small wheel drops down in front to keep the vehicle stable.



| Vehicle   | TL | Skill           | Agility | Speed    | Range  | Crew and Passengers | Cargo | Open? | Hull | Structure | Cost Lv | Shipping Size |
|-----------|----|-----------------|---------|----------|--------|---------------------|-------|-------|------|-----------|---------|---------------|
| Bushi 918 | 12 | Wheeled Vehicle | +2      | 340 km/h | 500 km | 1                   | No    | Yes   | 0    | 1         | 2,400   | 0.5 tons      |

Special Features: None

**Personal ATV** (Light Ground Vehicle, 2 Spaces): The personal ATV is a small, one or two person, open ATV. It sees wide use as a recreational vehicle but is also used as a utility vehicle and even for exploration. The compact fuel cell gives the small vehicle a very long range.

| Vehicle                    | TL | Skill           | Agility | Speed    | Range  | Crew and Passengers | Cargo | Open? | Hull | Structure | Cost Lv | Shipping Size |
|----------------------------|----|-----------------|---------|----------|--------|---------------------|-------|-------|------|-----------|---------|---------------|
| Bridgeport-Swift Sandpiper | 10 | Wheeled Vehicle | +1      | 135 km/h | 600 km | 2                   | No    | Yes   | 0    | 1         | 1,350   | 1 ton         |

Special Features: Off-road, Extended Range, Winch, Open Frame

**Family Car** (Light Ground Vehicle, 5 Spaces): This represents a typical family ground car of the type in use on most worlds. It is usually powered by a small fuel cell, although some rare colonies use petrochemical burners instead. The more common cars feature independent motors in each wheel powered by the inboard fuel cell or fed from a high-density battery. Front and back wheels can steer independently, allowing great manoeuvrability and ease of parking.

| Vehicle               | TL | Skill           | Agility | Speed    | Range  | Crew and Passengers | Cargo   | Open? | Hull | Structure | Cost Lv | Shipping Size |
|-----------------------|----|-----------------|---------|----------|--------|---------------------|---------|-------|------|-----------|---------|---------------|
| Sumatra-Fabrique S750 | 11 | Wheeled Vehicle | +1      | 150 km/h | 600 km | 4                   | 1 Space | No    | 2    | 3         | 6,100   | 2.5 tons      |

Special Features: Entertainment System, Autopilot (Drive +1), Basic Navigation (+1)

**Range Truck** (Light Ground Vehicle, 8 Spaces): This vehicle, similar in concept to 20th Century Humvees and jeeps, is a cross country vehicle designed to carry passengers and light cargo. On the Core worlds, these vehicles are relatively rare luxury vehicles but any available models come equipped with the standard TrafCon and navigation/tracking modules. On the Frontier, these vehicles are quite common, in personal, corporate, government and military use and are widely manufactured under a variety of brands and models.



| Vehicle                  | TL | Skill           | Agility | Speed    | Range  | Crew and Passengers | Cargo   | Open? | Hull | Structure | Cost Lv | Shipping Size |
|--------------------------|----|-----------------|---------|----------|--------|---------------------|---------|-------|------|-----------|---------|---------------|
| Houston Motors RangeStar | 11 | Wheeled Vehicle | 0       | 150 km/h | 600 km | 6                   | 2 Space | No    | 4    | 5         | 15,450  | 4 tons        |

Special Features: Off-road, Winch, Extended Range (+50%), Increased Structure (+1), Basic Navigation (+1), TL 8 Comm System, entertainment system

**Utility Van** (Light Ground Vehicle, 12 Spaces ): This is a general purpose passenger or cargo hauler used for light loads on roads. The basic frame for this vehicle is modular and can accept several different chassis models depending on requirements. These modules can typically be swapped out in less than a day. Modules available include a passenger mini-bus, ambulance, utility vehicle, tow truck (with extra fuel cell for more power and weight) and pickup truck. These vehicles are a common sight throughout the Core and any urbanised area in the Frontier

| Vehicle    | TL | Skill           | Agility | Speed    | Range  | Crew and Passengers | Cargo    | Open? | Hull | Structure | Cost Lv | Shipping Size |
|------------|----|-----------------|---------|----------|--------|---------------------|----------|-------|------|-----------|---------|---------------|
| Raven G250 | 10 | Wheeled Vehicle | -1      | 200 km/h | 375 km | 2                   | 10 Space | No    | 6    | 6         | 15,560  | 6 tons        |

Special Features: Autopilot (Drive/0), Basic Navigation (+1), TL 8 Comm, Entertainment System, Reduced Range, Reduced Agility

**Heavy Truck** (Heavy Ground Vehicle, 24 Spaces): This is a specialised cargo hauler for use on frontier worlds. While at its best on roads, its large tires, high ground clearance and all-wheel drive give it a reasonable off-road capability as well. In military service the vehicle is often equipped with a heavy ring mount on the left side of the cab for either a machinegun or autocannon. Similar versions exist in the Core but are much less capable of off-road movement and only Tier Four nations would use them as military vehicles.

| Vehicle       | TL | Skill           | Agility | Speed    | Range  | Armour | Crew and Passengers | Cargo    | Open? | Hull | Structure | Cost Lv | Shipping Size |
|---------------|----|-----------------|---------|----------|--------|--------|---------------------|----------|-------|------|-----------|---------|---------------|
| Iltis 3.5 6x6 | 10 | Wheeled Vehicle | -1      | 135 km/h | 500 km | 4      | 2                   | 40 Space | No    | 21   | 21        | 224,500 | 25 tons       |

Special Features: 6 Wheels, Off-road, Basic Navigation (+1), TL8 Comm

**Explorer ATV** (Heavy Ground Vehicle, 35 Spaces): A tracked wilderness vehicle popular with scientific parties. It can double as living quarters in hostile environments and can negotiate most types of terrain. It is designed to float and a built-in set of water jets can move it across water at up to 20 kilometres per hour. Accommodations are provided for four and most feature an inflatable, attached shelter, which can be used in almost any environment, to provide roomier quarters or shelter for an additional four. This model includes a fuel station, as described in the equipment section, to further extend its range.



| Vehicle           | TL | Skill           | Agility | Speed   | Range  | Armour | Crew and Passengers | Cargo    | Open? | Hull | Structure | Cost Lv | Shipping Size |
|-------------------|----|-----------------|---------|---------|--------|--------|---------------------|----------|-------|------|-----------|---------|---------------|
| Mulecorp Explorer | 12 | Tracked Vehicle | -1      | 90 km/h | 600 km | 5      | 4                   | 5 spaces | No    | 15   | 14        | 832,000 | 15 tons       |

Special Features: Tracked, Aquatic Propulsion, Advanced controls, Vacuum protection, Extended life support, Computer/5, Autodoc, Fresher, Mini-Galley, Standard Lab, Airlock, 4 bunks, Standard Sensors, TL 8 Comm w/uplink, Advanced navigation, Str 50 Winch, Fuel Processor, Inflatable Shelter



**Bridgeport-Swift Songbird** (Light Hover Vehicle, 6 Spaces): The Bridgeport Swift Songbird is a typical small hovercraft found throughout Human space. Although open-topped, it does come equipped with a tarpaulin for inclement weather.

| Vehicle  | TL | Skill      | Agility | Speed    | Range  | Armour | Crew and Passengers | Cargo | Open? | Hull | Structure | Cost Lv | Shipping Size |
|----------|----|------------|---------|----------|--------|--------|---------------------|-------|-------|------|-----------|---------|---------------|
| Songbird | 11 | Hovercraft | +1      | 250 km/h | 600 km | 4      | 4                   | 2     | Yes   | 1    | 2         | 26,500  | 4 tons        |

Special Features: Basic Nav, TL 8 Commo, Standard Controls

### CARGO HANDLING EQUIPMENT

These pieces of equipment can be found at warehouses and spaceports across human space and the exo-loader forms the basis for a number of different machines used in a variety of industrial and commercial roles.

Pichot 4020 Heavy Materials Handler Human Physical Analogue Tool (4020

HMHPAT) (Heavy Exoskeleton, 16 Slots): The Pichot 4020 HMHPAT, usually called simply a 'Hump-it', is a battery-powered, articulated exoskeletal framework used for lifting small, heavy objects. It originated in Australia, by Pichot Industries and has since found widespread use in America as well.

The 'Hump-it' is something like an oversized human skeleton in appearance, with arms and legs and a torso cage to protect the operator's head and body. The operator climbs into the cage, rests his weight on the seat, places his feet into the feet of the 'Hump-it' and his hands onto the controls near the far end of the arms. When the operator moves his limbs, the 'Hump-it' moves its limbs in response but it enhances the operator's movement, allowing him to lift 15 times as much weight as he could lift unassisted. Walking is made simple through gyrostabilisers and automatic locks that virtually prevent falls. The long arm span of the 'Hump-it' allows the operator to lift objects that are up to two meters across.

|                   |           |
|-------------------|-----------|
| Slots             | 16        |
| Strength Modifier | +6        |
| Dex Modifier      | -2        |
| Armour            | 0         |
| Cost (Cr)         | Lv550,000 |
| Speed (Walk/Run)  | 2/10      |
| Duration          | 6 hours   |
| Shipping Size     | 0.15      |

Special Equipment: TL 8 Commo, +3 Strength, Loading Arms, Fire Extinguisher.

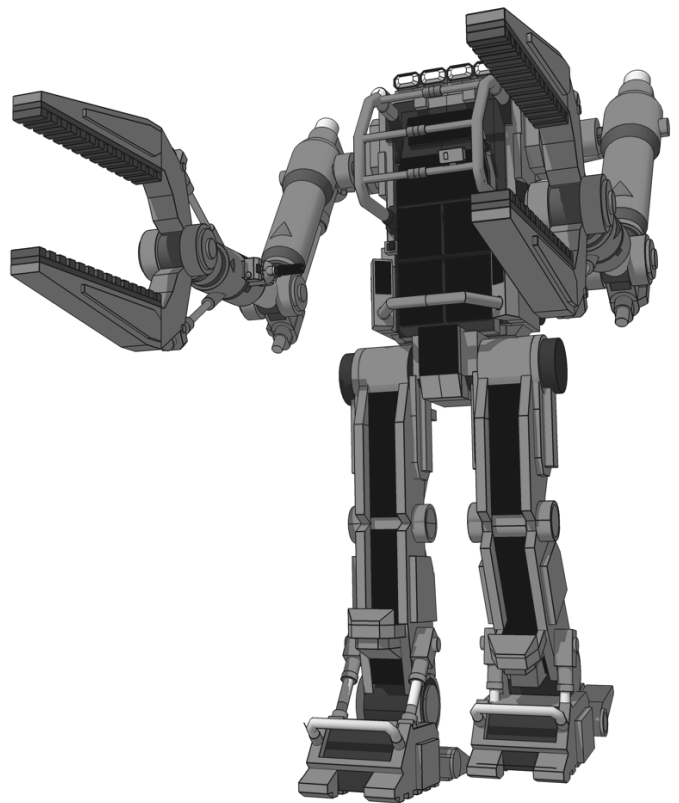



## Take off and landing

In addition to the normal set of vehicle statistics, aircraft are also rated for Take-Off Run and Landing Run. This is simply the runway length needed for a safe take-off or landing. Some aircraft are identified as VTOL and for these aircraft a different stat is included: Clearance. Clearance is the landing/take-off area diameter required for safe operation.

## AIRCRAFT

The following brief list gives a representative sample of the types of civilian aircraft in widespread use in the year 2300. Virtually all civilian aircraft carry, by law, radio transponders to assist air traffic controllers in aircraft location. Furthermore, on the Core Worlds, aircraft cannot be operated in urban areas unless under remote autopilot from the local TrafCon grid.

Most aircraft engines can operate at one level higher or lower in world gravity, i.e. an engine built for Normal Gravity would work in a High-Gee and a Low-Gee environment but would not work in a zero-gravity environment or an Extreme Gravity environment (like King). This takes into account both gravity differences and atmospheric density differences, as in most cases gravity and atmospheric pressure are closely linked

**Houston Aerospace UV-7 'Howey' Military Liaison and Civilian Light Transport** (Light Tilt-Rotor, 7 Spaces): This aircraft combines a vertical takeoff and landing capability with efficient level flight by means of two propfans which rotate on an axis through the centreline of the wings. When horizontal, they provide sufficient thrust to lift the aircraft off the ground. They are then rotated 90 degrees to provide forward thrust, with the conventional wing surfaces taking over lift.

| Vehicle | TL | Skill      | Agility | Speed    | Range    | Armour | Crew and Passengers | Cargo | Open? | Hull | Structure | Cost Lv | Shipping Size |
|---------|----|------------|---------|----------|----------|--------|---------------------|-------|-------|------|-----------|---------|---------------|
| UV-7    | 11 | Tilt-rotor | +2      | 450 km/h | 2,400 km | 4      | 5                   | 2     | No    | 1    | 2         | 572,000 | 7 tons        |

Special Features: Tilt-rotor, Basic Sensors (+0), Standard Navigation (+2), TL8 commo, Standard Controls, Autopilot (+2).

Base Environment: 86 Clearance: 20m radius

AeroDyne Manufacturing, Inc. UV-45 'Gull' Light Transport (Heavy Tiltrotor, 15 Spaces): This aircraft operates on a principle similar to that used on the light transport described previously. It has improved hover characteristics due to the use of two large radius conventional propellers. The aircraft's characteristically high wing ensures propeller clearance when landed. This particular model is capable of water landings and is often used aboard ships.

| Vehicle | TL | Skill      | Agility | Speed    | Range    | Armour | Crew and Passengers | Cargo | Open? | Hull | Structure | Cost Lv   | Shipping Size |
|---------|----|------------|---------|----------|----------|--------|---------------------|-------|-------|------|-----------|-----------|---------------|
| UV-45   | 11 | Tilt-rotor | 0       | 600 km/h | 5,000 km | 4      | 4                   | 10    | No    | 5    | 5         | 2,280,000 | 30 tons       |

Special Features: Tilt-rotor, Fresher, Amphibious, Rescue Crane (500kg capacity), TL8 Commo, Standard Navigation (+2), Basic Sensors (+0), Autopilot (Flyer +2).

Base Environment: 86 Clearance: 60m radius

## Airships and Wind Effects

Due to their large size and huge surface area, airships are vulnerable to high winds and have trouble manoeuvring. The following table provides DC modifiers for any movement action an airship takes.

| Wind Speed | DC  |
|------------|-----|
| Light      | 0   |
| Moderate   | +5  |
| Strong     | +10 |
| Severe     | +15 |
| Windstorm  | +20 |
| Hurricane  | +40 |
| Tornado    | +60 |

Magnus-type LTAs subtract five from these rolls.

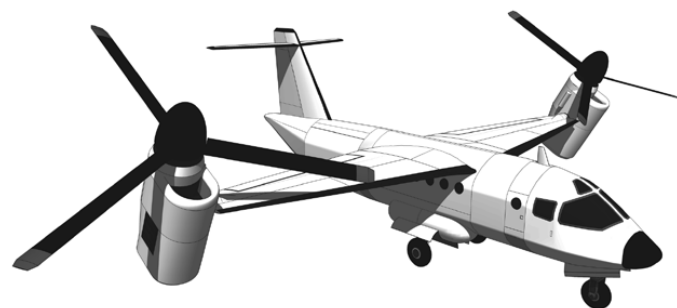

**Panavia Loadmaster** (Heavy Jet Aircraft): Capable of carrying either passengers or freight, this type of heavy-lift aircraft is very useful for quick transfer of large cargo loads on most worlds. The engines are mounted above and ahead of the wings increasing lift at low speeds and giving the aircraft a shorter takeoff distance than would be expected from an aircraft of this size.

| Vehicle     | TL | Skill    | Agility | Speed    | Range    | Armour | Crew and Passengers | Cargo | Open? | Hull | Structure | Cost MLv | Shipping Size |
|-------------|----|----------|---------|----------|----------|--------|---------------------|-------|-------|------|-----------|----------|---------------|
| Load-master | 12 | Aircraft | 0       | 500 km/h | 4,000 km | 5      | 4                   | 590   | No    | 125  | 125       | 49       | 600 tons      |

Special Features: STOL, TL 8 Commo, Standard Sensors (+1), Standard Nav (+2), Autopilot (Flyer +3) Mini-Galley, 2 bunks

Take-off Roll: 1,750 m      Landing Roll: 1,000 m      Base Environment: 86

**LuftWerk Gz-320 Cargo Airship** (Heavy Airship, 1,000 Spaces): This helium-filled rigid airship is an efficient and cost effective means of hauling large cargos to inaccessible areas. Using a lifting-body hull, the Gz-320 can carry immense loads and does not require any supporting infrastructure save a short (albeit very wide) runway for take-off and landing. Although slower than an airplane, the aerodynamic hull allows it to reach speeds surpassing conventional railways and is far faster than surface ships. Airfoil airships are the biggest vehicles ever to take to the skies, dwarfing even the largest shuttles and passenger aircraft.

| Vehicle | TL | Skill   | Agility | Speed    | Range    | Armour | Crew and Passengers | Cargo | Open? | Hull | Structure | Cost MLv | Shipping Size                |
|---------|----|---------|---------|----------|----------|--------|---------------------|-------|-------|------|-----------|----------|------------------------------|
| Gz-320  | 12 | Airship | -3      | 320 km/h | 6,000 km | 5      | 10                  | 912   | No    | 200  | 200       | 101      | 600 tons +1,600 ton envelope |

Special Features: Airfoil Airship, Autopilot (Flyer +2), Advanced Controls (+2), Standard Navigation (+2), Standard Sensors (+1), TL8 Commo, 10 bunks, 4 mini-galleys, 4 freshers, 4 heavy cranes (10 tons each)

Operating Environment: 86      Envelope Size: 160,000 tons (1,600 tons deflated)

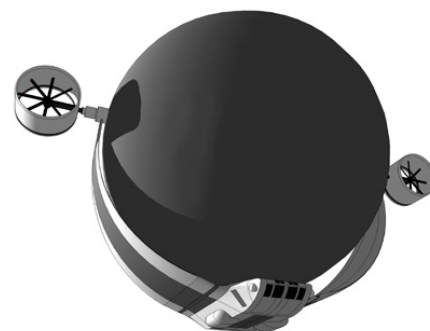

**Magnus L-20 Light Duty** (Light Airship, 65 Spaces): This handy little airship features a spherical, semi-rigid gas bag which, in flight, rotates around a central axis giving the vessel additional lift. The spherical gas bag also eliminates the tendency that larger cigar shaped airships have of 'weather-variant' in high winds (pointing their noses into the wind). This added stability gives it a much better all weather flight capability.

| Vehicle | TL | Skill   | Agility | Speed    | Range    | Armour | Crew and Passengers | Cargo | Open? | Hull | Structure | Cost MLv | Shipping Size |
|---------|----|---------|---------|----------|----------|--------|---------------------|-------|-------|------|-----------|----------|---------------|
| L-20    | 11 | Airship | -2      | 150 km/h | 4,000 km | 5      | 4                   | 60    | No    | 13   | 12        | 2        | 32.5 tons     |

Special Features: Magnus effect, Basic Sensors, basic nav (+1), TL 8 Commo, autopilot, (Flyer +2) fresher, mini-galley, 2000 kg crane

Envelope Size: (Size 8 world, Standard Density Atmosphere): 780 tons (7.8 tons deflated)

## WATERCRAFT

**Waverider Runabout** (Boat, 8 Spaces): The Waverider Runabout is a small, basic boat used for a variety of purposes, from sport fishing to fish-farming and even as a light pleasure craft, although its speed is far from extraordinary.

| Vehicle   | TL | Skill         | Agility | Speed   | Range  | Armour | Crew and Passengers | Cargo | Open? | Hull | Structure | Cost Lv | Shipping Size |
|-----------|----|---------------|---------|---------|--------|--------|---------------------|-------|-------|------|-----------|---------|---------------|
| Waverider | 10 | Surface Craft | 0       | 90 km/h | 800 km | 4      | 6                   | 2     | Yes   | 2    | 3         | 16,000  | 4 tons        |

Special Features: Open Seating, Open Cargo, TL8 Commo, Basic Nav (+1)

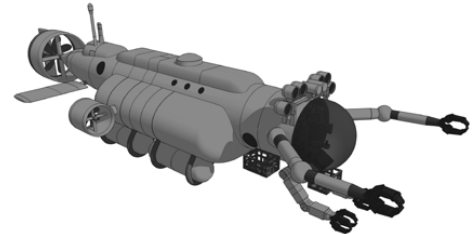

**Sea Squid Research Submersible** (Heavy Submarine, 15 Spaces): The Sea Squid is a utility sub adapted for research purposes. Originally designed to service deep-sea well-heads and thermal generators, it is well suited for a role in deep-water research. The Squid features several manipulators of different size and purpose and all the manipulators give it an appearance reminiscent of its namesake.

| Vehicle | TL | Skill     | Agility | Speed   | Range    | Armour | Crew and Passengers | Cargo | Open? | Hull | Structure | Cost MLv | Shipping Size |
|---------|----|-----------|---------|---------|----------|--------|---------------------|-------|-------|------|-----------|----------|---------------|
| Squid   | 12 | Submarine | 0       | 70 km/h | 2,000 km | 5      | 7                   | 2     | No    | 10   | 10        | 2.5      | 45 tons       |

Special Features: Advanced Navigation (+3), Advanced Controls, Auto-pilot, Computer /5, Neural Link, TL8 Commo, Standard Underwater Sensors (+1), Fresher, 2 bunks, mini-galley, Standard Lab, 4 manipulator arms, STR 12, DEX 7

Safe Depth: 2,000m      Crush Depth: 6,000m

## RAIL TRANSPORTATION

In the 24th century, there are three types of rail transports. Each has its own particular applications. Regardless of the type, rail cars all follow certain standards. Passenger cars are designed to carry people and include standard cars, which seat 80, sleeper cars, which will accommodate 30 and dining/lounge cars, which have facilities for up to 40 people at a time. Cargo cars vary from boxcars, which can carry up to 50 tons of mixed freight, to more special purpose cars, such as grain carriers, fuel and chemical tanks and bulk cargo. These more specialised cars can typically carry up to 60 tons.

**Conventional Train** (Conventional Train, 1,204 Spaces): Trains are efficient means of moving large quantities of cargo and passengers by land. Each car rides on solid wheels, which in turn ride on solid tracks. This allows very high pressure loads (much higher than for vehicles which ride on open ground) and so large, heavy cargos can be moved in an inexpensive fashion.

| Vehicle          | TL | Skill | Agility | Speed    | Range    | Armour | Crew and Passengers | Cargo                   | Open? | Hull | Structure | Cost MLv | Shipping Size |
|------------------|----|-------|---------|----------|----------|--------|---------------------|-------------------------|-------|------|-----------|----------|---------------|
| BM-98 locomotive | 10 | Drive | -4      | 160 km/h | 1,000 km | 4      | 2                   | 1,200 Spaces in 30 cars | No    | 120  | 120       | 4.9      | 120 tons      |

Special Features: Autopilot (Drive +2), Basic sensors (+0), Basic Navigation (+1), TL Commo with extended range, Fresher, mini-galley

**Passenger Railcar** (Conventional Rail Car, 40 Spaces): This class of railcar would be seen on most routes, capable of carrying 40 passengers in relative comfort. Commuter trains would pack in more passengers, perhaps upwards of 80 or more. The railcar is towed behind a locomotive and is incapable of movement on its own.

| Vehicle  | TL | Skill | Agility | Speed    | Range    | Armour | Crew and Passengers       | Cargo           | Open?  | Hull | Structure | Cost Lv | Shipping Size |
|----------|----|-------|---------|----------|----------|--------|---------------------------|-----------------|--------|------|-----------|---------|---------------|
| Rail Car | 10 | N/A   | -4      | As Train | As Train | 4      | 30/60/90 as Passenger Car | 40 as Cargo Car | No/yes | 10   | 10        | 80,000  | 20 tons       |

Special Features: Fresher, mini-galley

The typical enclosed car holds 40 Spaces and costs Cr 80,000.

An open, flat car costs Cr 60,000 and can hold up to 40 Spaces of exposed cargo.

A passenger car holds 40 people or 80–120 in high-capacity modes.

**Airfilm Train (Train, 604 Spaces):** Airfilm trains also ride on hard rails but interact by means of a thin, high pressure airfilm instead of wheels. This allows even higher pressure loads with very little friction. Emergency wheels are designed to deploy should the air cushion ever fail.

| Vehicle  | TL | Skill | Agility | Speed    | Range    | Armour | Crew and Passengers | Cargo      | Open? | Hull | Structure | Cost MLv | Shipping Size |
|----------|----|-------|---------|----------|----------|--------|---------------------|------------|-------|------|-----------|----------|---------------|
| Blohm 45 | 11 | Drive | -4      | 320 km/h | 1,000 km | 4      | 2                   | 600 Spaces | No    | 60   | 60        | 7.4      | 120 tons      |

Special Features: Autopilot (Drive +2), Basic sensors (+0), Basic Navigation (+1), TL 8 Commo with extended range, Fresher, mini-galley

Maglev Trains: On vacuum worlds, it is unfeasible to support a train on a film of air. Instead, a strong magnetic field is generated around the rail that the train travels along. These systems are also used in the tube-train systems of Earth, where they travel at high speeds along partially-evacuated tunnels.

| Vehicle | TL | Skill | Agility | Speed    | Range    | Armour | Crew and Passengers | Cargo      | Open? | Hull | Structure | Cost MLv | Shipping Size |
|---------|----|-------|---------|----------|----------|--------|---------------------|------------|-------|------|-----------|----------|---------------|
| TGV-12  | 11 | Drive | -4      | 480 km/h | 1,000 km | 4      | 2                   | 600 Spaces | No    | 60   | 60        | 11.8     | 120 tons      |

Special Features: Autopilot (Drive +2), Basic sensors (+0), Basic Navigation (+1), TL 8 Commo with extended range, Fresher, mini-galley

# MILITARY VEHICLES

This section includes a few samples of the many different types and classes of military vehicles available.

The statistics for weapons and ordnance can be found at the end of this chapter.

**Kangaroo IV ACV-APC** (Heavy Hover AFV, 19 spaces): A typical air-cushion, armoured personnel carrier, the extra weight of the vehicle is carried at high speed by jet assisted vectored thrusters. These also give the vehicle a limited jump-jet capability, enabling it to negotiate cliffs and similar obstructions. Each minute in jump-jet mode uses 10 minutes of fuel and speed is quartered. In addition to the main weapons, the Kangaroo also has four firing ports for infantry weapons. In the Tanstaafli Free Legion, the crews tend to use automatic shotguns in the weapon ports.



| Vehicle  | TL | Skill      | Agility | Speed    | Range  | Armour | Crew and Passengers | Cargo | Open? | Hull | Structure | Cost Lv   | Shipping Size |
|----------|----|------------|---------|----------|--------|--------|---------------------|-------|-------|------|-----------|-----------|---------------|
| Kangaroo | 11 | Hovercraft | +1      | 145 km/h | 900 km | 32     | 12                  | 0     | No    | 6    | 7         | 1,350,000 | 9.5 tons      |

Special Features: AFV, Jump Jets, TL8 Encrypted Comm, Standard Sensors (+1), Standard Navigation (+2), Firing ports (4) for infantry weapons.

Weapons: CLP-1A plasma gun and 20mm autocannon in remote turret, 4 firing ports.

Defences: Smoke Launchers (6), Flare Launchers (6), Chaff Launchers (6), Prismatic Aerosol Dispenser (6), Explosive Belt Anti-missile system.

| Weapon            | Location | Damage | Range   | Auto | Ammo   |
|-------------------|----------|--------|---------|------|--------|
| 20mm Autocannon   | Turret   | 5d6 AP | V. Dist | 12   | 10,000 |
| CLP-1A Plasma Gun | Turret   | 8d6    | V. Long | No   | 50     |

| Location     | Armour |
|--------------|--------|
| Front Hull   | 48     |
| Right Side   | 32     |
| Left Side    | 32     |
| Rear         | 24     |
| Dorsal       | 24     |
| Ventral      | 24     |
| Turret Front | 48     |
| Turret Other | 32     |

| Weapon             | DAM | Shots     | Targets | DM |
|--------------------|-----|-----------|---------|----|
| Explosive Belt AMS | 4d6 | 10/facing | 8       | -5 |

**AC 8 (Aero Char-8)**(Heavy Hover AFV, 20 Spaces): Often called ‘gunplats’ or ‘gunsleds’, hovertanks are the cutting edge of heavy ground force units. The Aero Char 8 is representative of many similar tanks of Central Asian War vintage. The AC-8 uses vectored thrust jets which give it a limited jump jet capability, enabling it to negotiate cliffs and similar obstructions. Each minute in jump-jet mode uses 10 minutes of fuel and speed is quartered.



| Vehicle | TL | Skill      | Agility | Speed    | Range  | Armour | Crew and Passengers | Cargo | Open? | Hull | Structure | Cost MLv | Shipping Size |
|---------|----|------------|---------|----------|--------|--------|---------------------|-------|-------|------|-----------|----------|---------------|
| AC-8    | 11 | Hovercraft | +1      | 165 km/h | 900 km | 80     | 2                   | 0     | No    | 6    | 7         | 12.4     | 10 tons       |

| Location     | Armour |
|--------------|--------|
| Front Hull   | 120    |
| Right Side   | 70     |
| Left Side    | 70     |
| Rear         | 70     |
| Dorsal       | 80     |
| Ventral      | 70     |
| Turret Front | 120    |
| Turret Other | 80     |

Special Features: AFV, Jump Jets, TL10 Encrypted Comm, Advanced Sensors (+1), Standard Navigation (+2), Advanced Controls, Neural Link, IR Mask II, Computer Model/2, Improved Fire Control +2, Hostile Environment Protection, Boosted Speed.

Weapons: 70mm mass driver in fixed forward sponson mount, Aero-27 missile launcher in fixed forward mount, 20mm autocannon in remote turret.

Defences: Smoke Launchers (6), Flare Launchers (6), Chaff Launchers (6), Prismatic Aerosol Dispenser (6), Explosive Belt Anti-missile system, Mini-gun Anti-missile system.

| Weapon                   | Location     | Damage       | Range      | Auto | Ammo  |
|--------------------------|--------------|--------------|------------|------|-------|
| 20mm Autocannon          | Turret       | 5d6 AP       | V. Long    | 4    | 1,000 |
| 70mm Mass Driver         | Forward Hull | 14d6 Mega AP | Distant    | 4    | 40    |
| Aero-27 missile launcher | Forward Hull | As missile   | As missile |      | 5     |

| Weapon      | TL | DAM | Shots | Targets | DM |
|-------------|----|-----|-------|---------|----|
| Minigun AMS | 8  | 1d6 | 10    | 3       | -5 |

| Weapon             | DAM | Shots     | Targets | DM |
|--------------------|-----|-----------|---------|----|
| Explosive Belt AMS | 4d6 | 10/facing | 8       | -5 |

**LkPz-IX** (Heavy Hover AFV, 18 Spaces): Developed in Hanover shortly before the War of German Reunification, the LkPz-IX is one of the most advanced armour systems in use anywhere. Unlike some other weapons platform, it relies exclusively on its hypervelocity mass-driver for its firepower. Low to the ground, fast and heavily armed and armoured, the LkPz-IX is a tanker's dream. It is also expensive and a nightmare to keep maintained.

The LxPz-9 uses vectored thrust jets that give it a limited jump jet capability, enabling it to negotiate cliffs and similar obstructions. Each minute in jump jet mode uses 10 minutes of fuel and speed is quartered.

| Vehicle | TL | Skill      | Agility | Speed   | Range    | Armour | Crew and Passengers | Cargo | Open? | Hull | Structure | Cost MLv | Shipping Size |
|---------|----|------------|---------|---------|----------|--------|---------------------|-------|-------|------|-----------|----------|---------------|
| Lk-PzIX | 12 | Hovercraft | +1      | 315km/h | 1,050 km | 100    | 2                   | 0     | No    | 4    | 5         | 14.8     | 9 tons        |

| Location     | Armour |
|--------------|--------|
| Front Hull   | 150    |
| Right Side   | 90     |
| Left Side    | 90     |
| Rear         | 90     |
| Dorsal       | 100    |
| Ventral      | 90     |
| Turret Front | 150    |
| Turret Other | 100    |

Special Features: AFV, Jump Jets, TL10 Encrypted Comm with uplink and tightbeam, Advanced Sensors (+2), Advanced Navigation (+3), Advanced Controls, Neural Link, IR Mask III, Stealth II, Computer Model/3, Advanced ECM, Improved Fire Control +3, Life Support, short-term, Hostile Environment Protection, Boosted Speed (+100%).

Weapons: 65mm mass driver in large remote turret, machinegun in forward hull.

Defences: Smoke Launchers (12), Flare Launchers (12), Chaff Launchers (12), Prismatic Aerosol Dispenser (12), Explosive Belt Anti-missile system, Laser Anti-missile system.

| Weapon           | Location     | Damage       | Range      | Auto | Ammo |
|------------------|--------------|--------------|------------|------|------|
| 65mm Mass Driver | Forward Hull | 16d6 Mega AP | V.Distance | 4    | 80   |
| Heavy Machinegun | Forward Hull | 5D6 AP       | Very Long  |      | 5    |

| Weapon         | DAM | Shots     | Targets | DM |
|----------------|-----|-----------|---------|----|
| Explosive Belt | 4d6 | 10/facing | 8       | -5 |

| Weapon    | DAM | Shots | Targets | DM |
|-----------|-----|-------|---------|----|
| Laser AMS | 2d6 | —     | 7       | -7 |

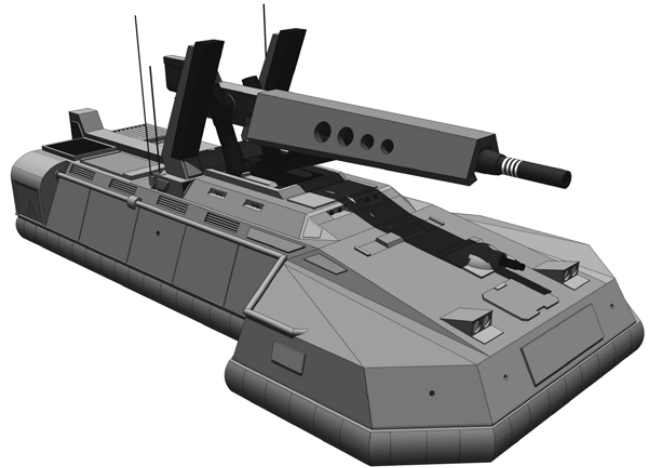

**Lynx Armoured Scout Vehicle** (Light Ground Vehicle): This light wheeled vehicle is often deployed as an air-mobile or star-mobile vehicle, similar in role to some light hovercraft, yet far less expensive.

It sports an advanced sensor suite, including a pair of drones and a sensor mast that allows it to use all of its sensors from under cover.

In addition to the sensor suite, it is also equipped with a 25mm autocannon, a pair of anti-armour missiles and a heavy machine gun. Defensively, it mounts an explosive-belt anti-missile system but otherwise the armour is relatively light.



| Vehicle | TL | Skill          | Agility | Speed    | Range  | Armour | Crew and Passengers | Cargo | Open? | Hull | Structure | Cost Lv  | Shipping Size |
|---------|----|----------------|---------|----------|--------|--------|---------------------|-------|-------|------|-----------|----------|---------------|
| Lynx    | 12 | Ground Vehicle | +2      | 175 km/h | 600 km | 15     | 4                   | 1     | No    | 7    | 8         | 178, 300 | 7.5 tons      |

Special Features: Aquatic Propulsion, Increased Range (+66%), Increased Agility, Advanced Controls, Extra Armour, 8 wheels, Hostile Environment Protection, Computer/1, Advanced Sensors (+2), Advanced Navigation (+1), TL10 Encrypted Commo with satellite uplink, 2 Recon Drones in internal racks.

Weapons: Small Turret with 20mm autocannon and 2 Guiscard-12 Missiles, pintle mount with heavy machinegun.

Defences: Smoke (6), prismatic aerosols (6), Explosive Belt Anti-Missile System.

| Weapon                    | Location       | Damage | Range   | Auto | Ammo  | Weapon             | DAM | Shots     | Targets | DM |
|---------------------------|----------------|--------|---------|------|-------|--------------------|-----|-----------|---------|----|
| 20mm Autocannon           | Turret         | 5d6 AP | V. Dist | 4    | 1,000 | Explosive Belt AMS | 4d6 | 10/facing | 8       | -5 |
| Guiscard Missile Launcher | Turret         | Varies | Varies  | No   | 2     |                    |     |           |         |    |
| Heavy Machinegun          | Forward pintle | 4d6    | Dist    | 4    |       |                    |     |           |         |    |

## Aircraft and World Gravity

All aircraft are designed and rated for a specific atmosphere mix and planetary gravity. In game terms, this means that aircraft can only work properly for world size and atmosphere type UPP codes within 1 of their homeworld. So an airplane designed on a world with UPP of C772777-9 could function properly on a world with atmosphere codes of 6-8 and size codes of 6-8. It is possible to build an aircraft with a wider operational range, but it will be more expensive and less Agile.

Aircraft operating outside of their design codes suffer a -1 to Agility unless they are designed with a wider operation range.

In any case, all aircraft require a minimum atmosphere code of 1 in order to function.

Aircraft descriptions should include the world size and atmosphere codes.



## MILITARY AIRCRAFT

**Merlin GR.4 Attack Fighter** (Heavy Jet Aircraft): The Merlin is a British aircraft optimised to perform best under primitive conditions, a feature extremely useful on Frontier worlds where massive paved airstrips are infrequent except at spaceports. Like most modern military aircraft, the pilot sits in an enclosed, armoured cockpit, with all information relayed to his helmet-based display system from an array of sensors and cameras spread throughout the fuselage of the aircraft. The Merlin's vectored thrust engines, in addition to giving it a vertical takeoff capability, also make it extremely maneuverable.

| Vehicle | TL | Skill | Agility | Speed      | Range    | Armour | Crew and Passengers | Cargo | Open? | Hull | Structure | Cost MLv | Shipping Size |
|---------|----|-------|---------|------------|----------|--------|---------------------|-------|-------|------|-----------|----------|---------------|
| Merlin  | 12 | Flyer | +2      | 1,500 km/h | 2,400 km | 10     | 1                   | 0     | No    | 7    | 8         | 17.4     | 30 tons       |

Special Features: Transonic, VTOL, Autopilot (Flyer +2), Ejection Seat, Neural Link (+2 Agility, +1 Initiative), Enhanced Agility (+1), Increased Armour, Standard Navigation (+1), Standard Sensors with Extended Range (+2), TL10 Commo, encrypted, Life Support (Short Term, 8 hours), Extended Operational Environment (2 steps above or below Base Environment).

Base Environment: 86 Defences: Flares (12), chaff (12), prismatic aerosols (12).

| Weapon                      | Location | Damage | Range   | Auto | Ammo  |
|-----------------------------|----------|--------|---------|------|-------|
| 20mm Rotary Autocannons (2) | Forward  | 5d6 AP | V. Dist | 12   | 1,000 |
| Missile Bay                 | Forward  | Varies | Varies  | No   | 2     |

### SA.826F Zephyr 2 Close Support Gunship (Light Helicopter):

This type of aircraft uses the X-Wing concept to achieve a very good level flight performance, full vertical takeoff and landing capability and excellent hover characteristics. The aircraft is lifted aloft by the overhead, large diameter, four bladed rotor. Forward thrust is provided by a pair of shrouded conventional turbines. Once the craft is airborne and close to cruise speed, the rotor is stopped in flight and locked into place, the four blades forming an 'X' (hence the name X wing). In this position, the blades provide conventional lift (supplemented by the stub wings, which double as weapon pylons).



These aircraft usually operate in teams, with a sensor platform in support well behind the action. This allows these fighter helicopters to get by with only basic electronics.

Special Features: Neural Link, boosted agility, boosted speed, Basic sensors, Basic navigation, TL8 encrypted commo, computer, autopilot (+2), Extended Operational Environment.

| Weapon                 | Location | Damage | Range   | Auto | Ammo  |
|------------------------|----------|--------|---------|------|-------|
| 20mm Rotary Autocannon | Forward  | 5d6 AP | V. Dist | 12   | 1,000 |
| Missile Bay            | Forward  | Varies | Varies  | No   | 2     |

Base Environment: 86 Defences: Flares (6), chaff (6), prismatic aerosols (6)

| Vehicle | TL | Skill      | Agility | Speed    | Range    | Armour | Crew and Passengers | Cargo | Open? | Hull | Structure | Cost MLv | Shipping Size |
|---------|----|------------|---------|----------|----------|--------|---------------------|-------|-------|------|-----------|----------|---------------|
| Zephyr  | 11 | Helicopter | +4      | 500 km/h | 2,000 km | 8      | 1                   | 0     | No    | 2    | 3         | 1.2      | 4.5 tons      |

## COMBAT WALKERS

Combat walkers are armoured fighting vehicles based on a small walker chassis. Their role in modern tactics is as a sort of very heavy infantry and they typically operate in support of conventional infantry.

The first true combat walker was built near the middle of the 23rd Century. Since that time, a number of other types have been created but the French BH-21 and the Manchurian Type-44 remain the most commonly encountered varieties.

Combat walkers come in two main forms, the roughly humanoid types, used by most Western militaries and the pod type, consisting of a completely enclosed pod on top of a set of armoured legs, more often used by Manchurian forces and colonial militias. The humanoid types are 2.5–3 metres tall, while the pods are shorter but more bulky, usually 2–2.5 metres tall and 1.5–2 meters long. Humanoid walkers are considered to be armour rather than vehicles for purposes of acting in a round, while pod-types are considered to be vehicles. This means that in any engagement involving both humanoid and pod-type walkers, the pods will always move and act last. However, for purposes of determining damage, both types of walkers are classified as vehicles.

Humanoid-type combat walkers can carry and use conventional weapons in their arms. Pod-type walkers cannot use carried weapons.

**BH-21 Combat Walker** (TL 11 Heavy Combat Walker, 16 Slots): The BH-21 Combat Walker is a French-made suit of powered combat armour. It first debuted during the Central Asian War.

The BH-21 has powerful motors in the limbs that are slaved to the pilot's movements, an internal monitor that can expand up to a 360 degree view of the surrounding area, heavy NBC filters to provide clean air to the operator and three fixed hard-points, one on the right arm and one on each shoulder. A plasma gun in the left arm rounds out the suit's weaponry.

In addition to the Mk4-A3 PGCW on the left arm, typical weapons load-out includes either a DunArmCo 9mm rotary gun on the right shoulder or a drone mount or a point-defence weapon on the left shoulder. The right arm hard point is typically left open.

|                          |            |
|--------------------------|------------|
| <b>BH-21</b>             |            |
| <b>Strength Modifier</b> | +6         |
| <b>Dex Modifier</b>      | -4         |
| <b>Armour</b>            | 22         |
| <b>Cost (Cr)</b>         | Lv121,000  |
| <b>Speed (Walk/Run)</b>  | 2/10       |
| <b>Duration</b>          | 14.4 hours |
| <b>Shipping Size</b>     | 0.15       |

Special Features: Basic Sensors, Basic Commo, Basic Navigation, Smoke Discharger (6 reloads), Prismatic Aerosol Discharger (6 reloads), Enhanced Visual Sensors, Enhanced Audio Sensors.

Weapons: PGMP Mk2A3 in left arm, 9mm Gatling on right shoulder.

Defences: Belt-based Anti-missile system.

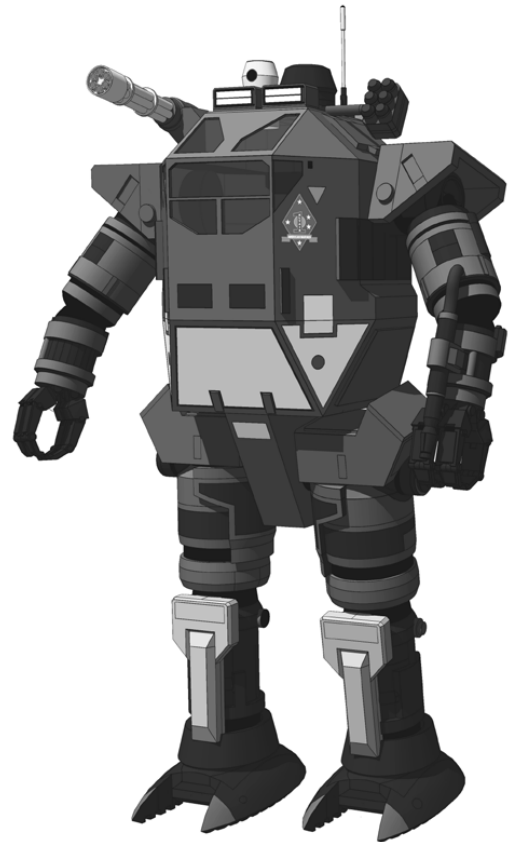

**Wu-Beijing Type-A6 Combat Walker** (Light Walker Vehicle, 4 Spaces): Having used combat walkers during the latter part of the Central Asian War, Manchuria was convinced of their utility but those early walkers were unable to stand up to the French BH-21 and the German Kz-7. Deciding that a new walker design was needed, Manchuria commissioned Wu-Beijing, one of its leading arms manufacturers, to create it. The result was the Wu-Beijing Type-A6, commonly called the 'Clamshell' by service members of other nations. The Type-A6 has many innovative aspects that set it off from standard powered combat armour.

First, the Type-A6 is not, strictly speaking, a suit of powered combat armour. The operator's arms and legs do not fit into the machine's limbs. Instead, the operator is entirely enclosed within the body of the walker; the machine's arms are small appendages operated by remote control and the legs are 'walked' by an advanced computer program. The main advantage to all of this is that the main body is much more horizontal, allowing its armour to deflect enemy fire more easily and making the entire construct much more stable during movement. If a Type-A6 is knocked off its feet by enemy fire, with the legs pulled up close, the walker will almost always roll to its belly, allowing it to regain its feet very easily (Skill Check is Driver (walker) Routine).

The Type-A6 is also airtight, allowing it to operate in hazardous atmospheres and it floats, allowing it to swim small, inland bodies of water. A turret-mounted Type-17 High Energy Plasma Gun completes the system.

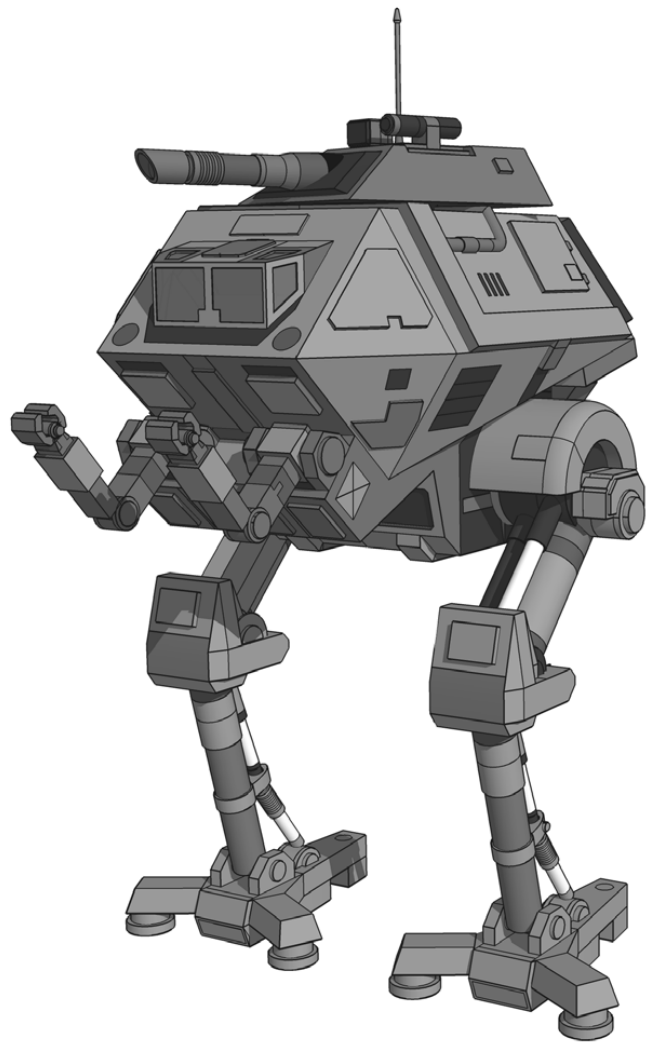

| Vehicle | TL | Skill  | Agility | Speed   | Range  | Armour | Crew and Passengers | Cargo | Open? | Hull | Structure | Cost Lv | Shipping Size |
|---------|----|--------|---------|---------|--------|--------|---------------------|-------|-------|------|-----------|---------|---------------|
| Type-A6 | 11 | Walker | +2      | 50 km/h | 150 km | 12     | 1                   | 0     | No    | 1    | 1         | 102,000 | 4 tons        |

Special Features: Basic sensors, Basic navigation, Standard controls, TL8 encrypted comms, Amphibious, Improved Fire Control (+1), Hostile Environment Protection, Explosive Belt Anti-missile system, 2 Manipulator Arms (Str 5, Dex 3).

| Weapon             | Location | Damage | Range   | Auto | Ammo |
|--------------------|----------|--------|---------|------|------|
| Type 17 Plasma Gun | Turret   | 7d6    | V. Dist | 0    | 20   |

## **VEHICLE ORDNANCE**

These weapons are typical of many of the vehicle-mounted ordnance available. A hardpoint weapon can be mounted on any vehicle hardpoint with enough capacity to carry it. Bay-mounted weapons do not need to have the launcher. The launcher is only for installation on ground vehicles.

## **MISSILES**

There are a number of vehicle-mounted missile systems available. There are a few special rules regarding missiles, which are dealt with in the section on vehicle combat.

**Guiscard Manta 1:** The Manta-1 was one of the first generation of hyperkinetic anti-tank missiles, using a solid-fuel, air-breathing motor to achieve Mach 5 speeds shortly after launch.

Type: Obsolete Vehicle-mounted anti-vehicle missile

Country: France

Guidance: Automatic

Attack Angle: Selectable

**Guiscard Aero-22:** The Aero-22 is an advanced silhouette-seeking missile that homes in on vehicle profiles. The heavy HEAP warhead is capable of punching through most modern armour.

Type: Vehicle-mounted anti-vehicle missile

Country: France

Guidance: Automatic

Attack Angle: Selectable

**Guiscard Aero-29:** The Aero-29 is a fast anti-aircraft interceptor missile, using a conventional explosive warhead.

Type: Vehicle-mounted air defence missile

Country: France

Flight time to maximum range: 5 min.

Guidance: Automatic following gunner lock-on

Attack Angle: Direct

**Luchs:** The Luchs is a hyperkinetic missile that launches at Mach 7 and damages its target solely through kinetic energy. There is no explosive in the warhead.

Type: Vehicle-mounted anti-vehicle missile

Country: Germany

Guidance: Automatic

Attack Angle: Selectable

**Ohu:** The Ohu is a large, vehicle mounted missile. The heavy warhead consists of three hyperkinetic sub-munitions that home in on their target.

Type: Vehicle-mounted air defence missile

Country: Germany

Flight Time to maximum range: 3 min

Guidance: Automatic following gunner lock-on

Attack Angle: Direct

## **TORPEDOES**

Similar in some ways to missiles, torpedoes are water-borne weapons used to attack submarines and surface shipping. Most torpedoes are of the super-cavitating type fired at speeds of up to 500 kilometres per hour. However, they are unguided weapons due to the difficulty of getting sensor information through the bubble generated around the weapon. Their high speeds usually mitigate this problem, however. The only counters to these weapons are super-cavitating interceptors and point-defence blue-green lasers.

**Blowfish:** A small torpedo usually used as a defensive weapon on larger boats and a back-up weapon on fighter subs. They can be used as interceptors against incoming torpedoes, with an additional -2 to hit. These are direct-fire, dumb weapons.

Type: Vehicle-mounted mini-torpedo

Country: Britain

Guidance: Unguided

Attack Angle: Direct

**Akula:** The Akula is a stealth torpedo developed by Russia as a counter to the big, noisy super-cavitating torpedoes. Using a magnetic tunnel drive and a synthetic case, it gets as close to the target as possible before igniting its super-cavitating drive for a 650 kilometre per hour sprint to the target. It can often get within the minimum range of point defence torpedoes and only has to worry about the laser systems. These torpedoes are large enough that they can often take a hit from the relatively low-powered lasers on subs.

Type: Vehicle-mounted Heavy Torpedo

Country: Russia

Guidance: Automatic after gunner lock-on

Attack Angle: Direct

## **BOMBS**

**200-Kilogram WASP Bomb:** The WASP (Wide-Angle Scatterable Projectiles) is an area-denial cluster bomb, throwing out large numbers of grenade-sized bomblets over its area of effect.

Type: Aircraft-guided bomb

Country: Generic

Guidance: Automatic following gunner lock-on

Attack Angle: Direct

**200-Kilogram High-Explosive Bomb:** This is a typical high-explosive bomb, designed to cause concussion and fragmentation damage to its targets.

Type: Aircraft-guided bomb

Country: Generic

Guidance: Automatic following gunner lock-on

Attack Angle: Direct

200-Kilogram Incendiary Bomb: The incendiary bomb is loaded with jellied petrochemical fuel and sticks to anything its hits, burning intensely for 1d6 minutes.

Type: Aircraft-guided bomb

Country: Generic

Guidance: Automatic following gunner lock-on

Attack Angle: Direct

400-Kilogram WASP Bomb: A larger variant of the standard 200 kilogram bomb, with a larger area of effect.

Type: Aircraft-guided bomb

Country: Generic

Guidance: Automatic following gunner lock-on

Attack Angle: Direct

400-Kilogram FAE Bomb: The fuel-area explosive or therobaric explosive, is the most powerful non-nuclear warhead available. It releases gaseous fuel over a large area, before igniting it to produce an exceptionally powerful explosion with massive over-pressure.

Type: Aircraft-guided bomb

Country: Generic

Guidance: Automatic following gunner lock-on

Attack Angle: Direct

# VEHICLE DESIGN CHANGES AND ADDITIONS

## VEHICLE PRICE MODIFICATIONS

Grav Vehicles: Not allowed.

Hover Vehicles: Hovercraft are much more common in 2300AD than in other settings. Reduce the base price of Light Hovercraft to Lv5,000 per Space and Heavy Hovercraft to Lv20,000 per Space.

Cybernetic Linkage (2300AD specific): This costs roughly 50% more than the standard price. Aircraft and spacecraft, being largely wired already, only cost an additional 10% to be equipped with the linkage equipment.

Battledress: (Humanoid Combat Walkers): Humanoid combat walkers in 2300AD use the same basic rules as battledress for other Traveller settings. Exoskeletons in 2300AD cost 10% of their cost in Traveller, while armour for battledress is only 500 per point, rather than 50,000. Base movement is halved, Duration is reduced to 10% of the listed value and all suits have a -2 DM to all Dex-based rolls except for To Hit rolls.

## Torpedoes

| Type     | Launcher Spaces | Torpedo Spaces | Damage | Radius | RoF | Rng        | Attack DM | Cost, Launcher | Cost, Missile |
|----------|-----------------|----------------|--------|--------|-----|------------|-----------|----------------|---------------|
| Blowfish | 3               | 20             | 4d6    | 3d6    | 1   | Distant    | +1        | Lv21,000       | Lv12,000      |
| Akula    | 6               | 500            | 6d6    | 2d6    | 1   | v. Distant | +3        | Lv24,000       | Lv35,000      |

## Bombs

| Type             | Bomb Spaces | Damage    | AOE     | RoF | Rng     | Attack DM | Cost, Bomb |
|------------------|-------------|-----------|---------|-----|---------|-----------|------------|
| 200kg WASP       | 1           | 4d6       | 4d6     | 1   | Distant | +2        | Lv1,500    |
| 200kg HE         | 1           | 8d6       | 4d6     | 1   | Distant | +0        | Lv1,800    |
| 200kg Incendiary | 1           | 6d6 flame | 3d6x5d6 | 1   | Distant | +0        | Lv2,700    |
| 400kg WASP       | 2           | 8d6       | 5d6     | 1   | Distant | +2        | Lv2,500    |
| 400kg FAE        | 2           | 10d6      | 6d6     | 1   | Distant | +2        | Lv5,000    |

| Type    | Launcher Spaces | Missile Spaces | Damage | Radius | RoF | Rng         | Attack DM | Cost, Launcher | Cost, Missile |
|---------|-----------------|----------------|--------|--------|-----|-------------|-----------|----------------|---------------|
| Manta-1 | 3               | 0.5            | 8d6    | 1d6    | 1   | Distant     | +2        | Lv15,000       | Lv12,000      |
| Aero-22 | 2               | 0.5            | 8d6    | 1d6    | 1   | Distant     | +3        | Lv14,300       | Lv14,600      |
| Aero-29 | 2               | 1              | 3d6    | 2d6    | 1   | Continental | +5        | Lv12,000       | Lv50,000      |
| Luchs-c | 3               | 0.5            | 8d6    | 1d6    | 1   | Distant     | +4        | Lv12,000       | Lv10,000      |
| Ohu-B   | 3               | 1              | 4d6    | 2d6    | 1   | Extreme     | +6        | Lv21,000       | Lv40,000      |

Walker Vehicles (Pod-type Combat Walkers): Like battledress, walker vehicles in 2300AD are typically subject to a speed decrease of 60%. While this would normally grant six extra Spaces, this is not the case with walkers. They do, however, get the price reduction of 50%.

### ADDITIONAL MODIFICATIONS

Fluidic G-suit: By filling the pilot's lungs with oxygenated fluorocarbons, the fluidic g-suit can compensate for a great deal of the G stresses a pilot can feel. The suit adds a +2 DM to all Endurance rolls associated with high-G manoeuvres. 1/2 space Lv50,000.

Cybernetic Linkage (2300AD specific): A cybernetic link for most vehicles costs roughly 50% of the standard base chassis price. Aircraft, large watercraft, submarines and spacecraft, being largely wired already, only cost an additional 10% to be equipped with the linkage equipment.

### VEHICULAR WEAPONS

These are the design tables for 2300AD specific weapons.

### LASER WEAPONS

The internal capacitors on laser cannons hold enough power to fire 10 shots and recharge at the rate of one shot per Combat Round. Like the mass drivers, below, additional capacitors can be added to the system, taking up 1/2 a space and holding an additional 5 shots, for 0.5MLv.

### LIGHT BLUE-GREEN LASER CANNON

| Weapon         | TL | Cost Lv | Damage | Auto | Spaces | Range | Ammo |
|----------------|----|---------|--------|------|--------|-------|------|
| Light UW Laser | 11 | 10,000  | 5d6    | —    | 2      | Long  | N/A  |

### MASS-DRIVER CANNONS

Mass driver cannons store enough power in their capacitors to fire 20 shots and typically recharge the capacitors at the rate of one shot per Combat Round. Additional capacitors can be added, with 1/2 a space holding enough power for an additional 5 shots, for 0.5 MLv.

| Weapon | TL | Cost MLv | Damage          | Auto | Spaces | Rng  |
|--------|----|----------|-----------------|------|--------|------|
| 65mm   | 12 | 12       | 16d6<br>Mega-AP | 5    | 8      | Dist |
| 70mm   | 11 | 10       | 14d6<br>Mega-AP | 5    | 10     | Dist |
| 75mm   | 10 | 8        | 12d6<br>Mega-AP | 5    | 12     | Dist |

### PLASMA GUNS

| Weapon | TL | Cost Lv | Damage         | Auto | Spaces | Rng  | Mag |
|--------|----|---------|----------------|------|--------|------|-----|
| CLP-1A | 11 | 30,000  | 8d6<br>Mega-AP | —    | 4      | Long | 10  |

### VEHICLE OPTIONS

Supercharger: Takes one space, lowers speed by 10%, charges three shots per round for energy weapons and mass drivers rather than one shot per round.

Small inflatable Shelter: Four rooms, sleeps four, plus common area and galley, two spaces, Lv2,000.

Large Inflatable shelter: Eight rooms, sleeps six, office space, common area and galley, four spaces, Lv5,000.

Winch: 2,000 kg capacity, Lv500.

# STARSHIP DESIGN

The purpose of this section is to modify the Mongoose *Traveller* design sequence to make it compatible with the technology and techniques of the *2300AD* universe. There are trade-offs made in both directions, for the purposes of playability and compatibility.

Starship construction in the 24<sup>th</sup> Century is an incredibly complex and sophisticated industry. Construction takes place in a wide variety of locations. Some vessels are built in large orbital yards, with components either constructed nearby in orbit or shipped up from a planet's surface. Some vessels, in particular the smaller ones, are constructed in planet-based facilities little different from those that assemble aircraft.

As ship-building is such an involved industry, much of it takes place at the Core worlds or at the most heavily-developed of the colony worlds, worlds like Nibelungen and Kie-Yuma. Other worlds also have ship-building industries but the most sophisticated components have to be shipped in, reducing the economic viability of those operations. In game terms, everything save the stutterwarp drive and the vessel's computers are built at the local Tech Level, while the imported components are built at the tech level of the originating world.

Like in *Traveller* and the original *2300AD*, ship-building has been simplified for the purposes of the game and only the most important elements in defining a ship's characteristics are detailed. The ship design process in *2300AD* is based on the ship design system found in the *Traveller Core Rulebook*. Any additions from *High Guard* are included in this design sequence.

When constructing a ship, two general procedures are followed: design and evaluation. Often a ship will need to be redesigned several times, based on its evaluation and how it fulfils its design goal. These two procedures are often on-going and continuous but for the purpose of the design sequence we will treat them separately.

*Units:* This design system is an amalgamation of the *Traveller* design rules and the original Naval Architects Manual. Some explanation is needed for the units of measure in this sequence.

Volume is measured in displacement tons, with one displacement ton being equal to 14 cubic metres.

Mass is not considered for the purposes of this design sequence but is roughly equal to displacement tonnage multiplied by three, in tons. An armoured vessel would mass more than this, roughly displacement tonnage multiplied by five.

Money in this design sequence will be in Livre, for compatibility with the *Traveller* design sequence all values in the *Traveller Core Rulebook* and other supplements should be read as Livre. Credits and Livre are equal in value.

The process of ship design begins with the concept and follows through in a manner similar to the *Traveller* ship construction system.

## CONCEPT

The first step in the design sequence is to decide what the purpose of the ship is. Is it a fighter, a cargo vessel, a warship? This enables you to decide what elements of the design sequence you want to emphasise. Although design proceeds in an orderly sequence, knowing what your priorities are allows you to set aside space or power for them later on in the process.

Ships designed for *2300AD* tend to be quite a bit smaller than their *Traveller* brethren. The largest military vessels come in at around 5,000 tons displacement, 10,000 at the most, while most vessels are less than 1,000 tons. *2300AD* is definitely a small-ships universe, as opposed to *Traveller*, where 5,000 tons is 'small' for a warship, which can go up to 500,000 tons for a dreadnought and some designs are even larger.

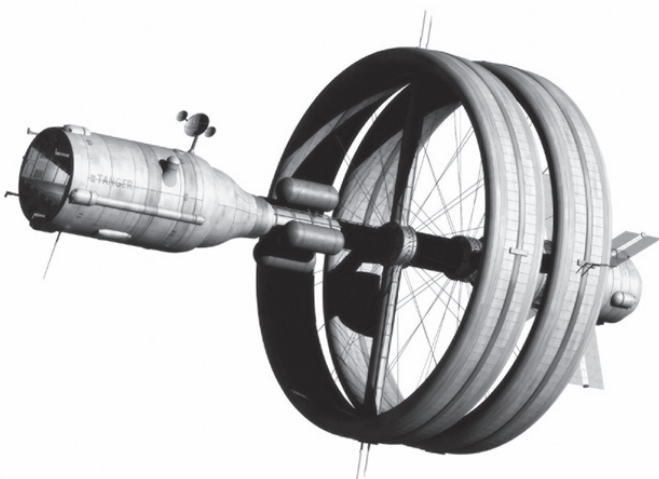

# SPACE CRAFT SIZE COMPARISONS

| Tonnage | Military Designation | Civilian Designation |
|---------|----------------------|----------------------|
| 1       | Missile              |                      |
| 5       | Drone                |                      |
| 10      | Launch               | Lifeboat             |
| 30      | Jolly Boat           | Boat                 |
| 40      | Fighter              |                      |
| 50      | Gig                  | Lighter              |
| 70      | Heavy Fighter        |                      |
| 90      | Skiff                | Longboat             |
| 95      | Shuttle              | Shuttle              |
| 100     | Cutter               | Courier              |
| 300     | Frigate              | Light Freighter      |
| 600     | Destroyer            |                      |
| 900     | Light Cruiser        |                      |
| 2,000   | Heavy Cruiser        | Heavy Freighter      |
| 3,000   | Battle Cruiser       |                      |
| 5,000   | Battle ship          | Bulk Carrier         |
| 10,000  | Dreadnought          | Colony Ark           |

Civilian vessels are largely designed to carry cargo. Most are not capable of landing, instead relying on local interface transport to carry cargo to and from a planet's surface. Some small vessels have surface-to-orbit capability but they tend to be couriers or luxury vessels, thus justifying the high cost of orbital operations.

Military vessels are designed to fill a variety of roles. Small navies will have multi-purpose warships, capable of handling almost any task, while the larger navies will have more specialised vessels. As a general rule, most navies categorise vessels based on size and the role they fill.

*Ship Classification:* For purposes of design, all ships fall into three broad classifications determined at the time of conceptualisation. A remote object is a vessel that has no crew onboard. This covers recon drones, missiles and Sentinels (semi-intelligent mobile mines). If the ship has a crew but is intended for short-duration missions, typically of 12 hours or less, then it is considered a small ship. Fighters and landing craft typically fall under this heading. If a vessel has a crew and is intended for long-duration missions, then it is considered a large ship. Most starships fall into this category, whether military or civilian.

The ship classification will dictate certain procedures to be used in the design sequence, primarily in the type of bridge but also in accommodations and other areas.

## Small Ship and Large Ship Design Checklist

1. Choose a Hull.
  - a. Choose Hull configuration.
  - b. Optionally, install armour and choose hull material.
  - c. Optionally, choose Hull and Armour Options.
2. Manoeuvre Drive.
  - a. Decide what the cruising acceleration for the ship should be, if required and cross-reference it with the ship's tonnage on the Performance by Hull Volume table (*Traveller Core Rulebook* page 108) to determine the Manoeuvre Drive required.
  - b. Choose what type of reaction drive is desired and alter tonnage and cost from the table, for previous, as required.
  - c. Allocate reaction drive fuel.
3. Stutterwarp Drive.
  - a. Decide what the warp speed should be for the vessel and cross reference that with the Stutterwarp Drive by Hull Volume table on page 108.
4. Choose a Power Plant, ensuring that it can provide enough power for the Stutterwarp, Manoeuvre Drive and Active Sensors. Power plants can be found on page 200.
5. Work out fuel requirements and allocate space to fuel.
6. Install a bridge or Small Craft cockpit.
  - a. Install bridge options - Available bridge options from *High Guard* are detailed on page 44.
  - b. Install Cockpit options.
7. Install a computer.
  - a. Install computer software. If a stutterwarp drive is installed, then the ship needs Stutterwarp Control software.
8. Install sensors.
  - a. Install Optional sensors.
9. Determining Crew Size.
  - a. Automation.
10. Install staterooms and low berths.
  - a. Install other accommodation options.
11. Install Artificial Gravity.
12. Optionally, install other components like vehicles, fuel processors or drones.
13. Determine Vessel Comfort Rating.
14. Install Defences (optional).
15. Weapon mounts and fire including turrets, jack turrets, gun towers, missile launchers and sub-munitions dispensers.
  - a. Optionally, install one ton of fire control equipment per turret or barbettes (UTES).
  - b. Optionally, install five tons of fire control equipment per 10 turrets or barbettes (TTA).
  - c. Optionally, install one ton of drone control per missile or drone (expected in flight).
16. Optionally, install weapons.
  - a. Missile launchers, railguns, sub-munition dispensers require ammunition.
17. Any remaining space can be allocated to cargo.



# TECHNOLOGY

The Technology Level in *2300AD* is a range from TL10 to TL12. TL 10 is also called Old Commercial, TL11 is New Commercial and Old Military and TL 12 is New Military.

Computers and electronics, however, are two Tech Levels higher, so Old Commercial electronics are TL12, New Commercial/Old Military are TL13 and New military are TL14.

Gravitic or gravitic-based technologies are not possible in this setting.

## CHOOSE A HULL

### **HULL and STRUCTURE**

Determining the Hull and Structure values of a starship hull is unchanged from *Traveller*. So one point of Hull and Structure per 50 tons of spacecraft. A 1,000 ton ship would have 20 points each of Hull and Structure.

However, as a further consideration, any vehicle that has taken more than 5% of its Hull value in damage will be unable to attempt atmospheric re-entry, as its heat shield will have been compromised. A skilled pilot may attempt to do so but the chances are not good. Failing this roll means that the vessel is destroyed on re-entry.

### **HULL MATERIAL**

*2300AD* uses completely different materials science in the construction of vehicles and spacecraft than the *Original Traveller Universe*. These materials are synthetic ceramic composites, incorporating ceramics, metals, plastics and quasi-ceramic materials in a complex sandwich. The resulting materials are exceptionally light and strong and easy to produce in moulded shapes. They are not so easy to fix after the fact, however and patched hulls have nowhere near the strength of the originals. In military service, damaged hull sections are typically replaced and recycled.

### **HULL COST**

Starship hulls in *2300AD* are cheaper than the ships of the *Original Traveller Universe* (OTU). Divide all hull costs by two. For any hull larger than 2000 tons, hull cost is equal to MLv0.05 x tonnage.

### **HULL CONFIGURATION**

Ship hulls can be classified according to their streamlining. An Unstreamlined hull cannot enter atmosphere, nor land, even on an airless world. A Standard streamlined hull can enter (or leave) atmosphere but cannot manoeuvre in atmosphere (conventional rockets and SSTOs). Airframe hulls generate lift and can manoeuvre in atmosphere (spaceplanes).

All hull types from the *Traveller Core Rulebook* are available. Distributed hulls cannot enter atmosphere or even land on an airless body, regardless of thrust available. Distributed hulls cannot have the 'Spun Hull' configuration for artificial gravity.

Standard hulls can have any type of spin habitat.

Streamlined hulls can only have retractable spin habitats.

### **STREAMLINING**

**Airframe Hull:** There are three types of airframe hull; Standard, Lifting Body and Hybrid Lifting Body. A standard hull is a typical winged vessel, like the space shuttle, which only generates lift via its wings. This is the standard hull form. A lifting body hull has no wings and generates lift through the shape of the hull. This makes it less efficient but less vulnerable to damage. Hybrid lifting bodies generate lift both through the shape of the hull and their wings and are the most efficient hull type, though the most expensive.

| Airframe Hull Type  | Size | Cost | Max Armour |
|---------------------|------|------|------------|
| Standard            | N/A  | N/A  | TL-6       |
| Lifting Body        | 0.02 | 0.02 | TL-3       |
| Hybrid Lifting Body | 0.01 | 0.01 | TL-5       |

Size is per ton of vessel. Cost is per ton of vessel.

### **Landing and Take-Off Runs**

All airframe hulls require landing and takeoff runs, except for VTOLs. The minimum length of runway is calculated as follows: Any vessel gliding to a landing is considered to have an ACC of 0.5 for purposes of this calculation.

| Airframe Hull Type  | Take-Off Run       | Landing Run       |
|---------------------|--------------------|-------------------|
| Standard            | (SIZE /ACC) x 250m | (SIZE/ACC) x 300m |
| Lifting Body        | x1.6               | x1.6              |
| Hybrid Lifting Body | x0.8               | x0.8              |

Size is the world's UWP Size Code and ACC is the vehicle's acceleration in Gs.

That's (World Size Code) divided by the Maximum Acceleration of the spacecraft, multiplied by 500, (or 1,000) in metres.

*A 2 G space plane taking off from Earth would have the following take-off run.*

*Earth is Size 8. So  $8/2 = 4$ .  $4 \times 250 = 1,000$  metres. The spaceplane has a 1,000 metre take-off run on earth and a landing run of 1,140 metres.*

Listed lifting body and hybrid runs are modifiers to the value of the Standard airframe hull.

## Atmosphere Effects

Thin Atmospheres will double these requirements, while Dense Atmospheres will halve them.

## VTOL and STOL hulls

Any airframe hull can also be made either VTOL (Vertical Take-Off and Landing) or STOL (Short Take-Off and Landing).

VTOL vessels must be able to generate more thrust than the local gravity. STOL halves take-off and landing run requirements.

| Hull Type | Tons | Cost |
|-----------|------|------|
| VTOL      | 10%  | 0.50 |
| STOL      | 2%   | 0.10 |

Tons is a percentage of the vessel's hull, cost is a percentage of the vessel's hull cost (after streamlining and material costs but before armour costs).

## STRUCTURE OPTIONS

These options alter the basic framework of the ship and require considerable time in a shipyard to install. Adding these options will double the standard construction time for any vessel.

*Disposable Hull:* Rockets are often built-as single-use vessels. In such a case, total up the final cost of the rocket and divide by two.

*Reinforced Structure:* By adding internal armour protection and structural reinforcement, a ship can withstand more structural damage. For every 5% of the ship's total tonnage allocated to reinforced structure, the ship gains extra structure points. Reinforced structure costs MLv 0.2/ton.

*Reinforced Hull:* Reinforcing the external hull is easier than reinforcing internal systems. For every 10% of the ship's total tonnage allocated to reinforced hull, the ship gains extra hull points. Reinforced hull costs MLv 0.1/ton.

*Armoured Bulkheads:* Armoured bulkheads protect any internal components to which they are added. Adding internal bulkheads requires tonnage equal to 10% of the tonnage of the protected system but negates the first hit on that system. For example, if a ship has a 30 ton Power Plant, then adding armoured bulkheads to protect the turbine costs three tons but means the first Power Plant hit is ignored. Armoured bulkheads cost MLv 0.2/ton.

## Armour

| Armour Type       | TL | Protection | Cost             | Max Armour |
|-------------------|----|------------|------------------|------------|
| Crystaliron Steel | 8  | 2 per 5%   | 5% of base hull  | 8          |
| Synthetic         | 10 | 4 per 5%   | 20% of base hull | 10         |
| Composite         | 12 | 6 per 5%   | 50% of base hull | 12         |

*Modular Hull:* Up to 75% of a ship's internal tonnage may be designated as modular, allowing it to be swapped out easily. This tonnage may not include the bridge, power plant, drives or any structural or armour options. Different modules can be installed for different tasks. Making a modular hull increases the cost of the overall hull by the percentage designated as modular. This cost is calculated after hull material and streamlining costs.

This is very common in larger freighters, which are built to handle either the 12 ton French standard or the newer 15 ton ISO standard.

*Example:* A 100 ton hull normally costs MLv 2.0. If 30% of the ship's hull is going to be made modular, then the cost of the hull is increased to MLv 2.6, 130% of the original cost. This means that 30 tons of the ship's components could easily be swapped out from mission-to-mission. When hauling passengers, the ship could install a module with six staterooms and six tons of cargo space (totalling 30 tons). When going into combat, the ship could install a module with a triple turret and a fighter hangar totalling 30 tons.

## ARMOUR

There are limitations on the amount of armour that can be added to a spacecraft due to the Technology Level of the materials. This is defined by the table that follows.

Armour does not need to be added in 5% elements but it must be added in whole armour point values. For example, the minimum element which can be added for Crystaliron Steel is 2.5%, which is a single point of armour.

Armour options must be added when the ship's armour is installed and cannot be easily retrofitted.

*Heat Shielding:* Heat shielding protects the ship against the heat of re-entry. This is required for all ships that are landing-capable. A ship attempting re-entry without heat shielding will burn up. If equipped with undamaged heat shielding, re-entry is successful on Difficult (-2) Astrogation, 10-60 minutes skill check, with failure resulting in burn up (this task is often undertaken more slowly).

Heat shielding does not provide protection against starship weapons; Heat shielding costs MLv 0.01 per ton of hull.

*Radiation Shielding:* Radiation shielding improves the ship's protection against radiation from both natural sources (solar flares) and artificial (nuclear bombs, particle beam strikes). A ship with radiation shielding decreases the amount of rads absorbed by

all crew by 1,000, treats the bridge as if it is hardened and has six extra armour points against radiation damage from nuclear weapons, particle beams and x-ray lasers. Radiation shielding costs MLv 0.1 per ton of hull.

The Reflec Option from the *Traveller Core Rulebook* page 106 is not available.

Self-Sealing Remains as written.

The Stealth Option remains as written.

### Reinforced Hull

| Hull Size    | Reinforced Structure | Reinforced Hull |
|--------------|----------------------|-----------------|
| 10–100       | 1                    | 3               |
| 101–1,000    | 2                    | 5               |
| 1,001–2,000  | 4                    | 10              |
| 2,001–10,000 | 8                    | 20              |

### SMALL CRAFT HULLS

Hulls are identified by their displacement, expressed in tons.

## MANOEUVRE DRIVES

2300AD lacks the gravitic manoeuvre drives of other *Traveller* settings, so a wide variety of technologies are used to leave the surface of planets and travel in local space. Longer voyages are almost always via stutterwarp, even within the same system.

### REACTION DRIVES

Ships in 2300AD require reaction drives to reach orbit from a planet's surface. Even in 2300, these systems are large, bulky and consume

vast quantities of fuel. Most starships dispense with thrusters, save for station-keeping and reaction-control systems, which are included in the cost and volume of the hull. Most worlds have dedicated interface vehicles to handle surface-to-orbit traffic. Only the smallest of the ships will have any sort of landing capability. Some ships do have reaction drives, however, including ones used extensively in orbital and asteroid-mining operations.

Ships larger than 600 tons generally do not have reaction drives and can only land on worlds with gravity of less than 0.4G. Ships larger than 1,000 tons cannot land at all.

The base thruster is the same size and performance as a *Traveller* manoeuvre drive and uses the tables from pages 107–108 in the *Traveller Core Rulebook*. Fuel consumption varies from type-to-type, however. The formula for fuel consumption from *High Guard* is:

Fuel Required (as a percentage of the ship's displacement) = % x Maximum Thrust x hours of Maximum thrust desired

‰: Refers to the fuel consumption figures from the Reaction Drive Table, page 195.

This fuel consumption formula is modified based on the type of reaction drive used.

### Fuel consumption for landing and takeoff

For airframe vessels, fuel should be allocated for taking-off and landing. Enough fuel for three hours of operation is standard for the take-off leg. For landing, usually only one hour is required, as most space planes will glide in after their de-orbit burn. This applies to the Standard Airframe configuration. For Lifting Body hull types, they should add one hour to the inbound journey, as they are not as efficient. Hybrid designs can reduce take-off fuel by one hour and landing fuel by ½ an hour. A powered landing requires as much fuel as a take-off and is modified similarly.

### Base Flight Times to Low Orbit

| Hull Type             | Take off | Landing | Powered landing |
|-----------------------|----------|---------|-----------------|
| Rocket or SSTO        | 2 hours  | 3 hours | 2 hours         |
| Standard Airframe     | 3 hours  | 1 hour  | 3 hours         |
| Lifting Body Airframe | 4 hours  | 2 hours | 4 hours         |
| Hybrid Airframe       | 2 hours  | ½ hour  | 2 hours         |

| Hull Size | Size Code | Price (MLv) | Hull | Structure |
|-----------|-----------|-------------|------|-----------|
| 10 tons   | S1        | 1           | 0    | 1         |
| 20 tons   | S2        | 1.2         | 0    | 1         |
| 30 tons   | S3        | 1.3         | 0    | 1         |
| 40 tons   | S4        | 1.4         | 1    | 1         |
| 50 tons   | S5        | 1.5         | 1    | 1         |
| 60 tons   | S6        | 1.6         | 1    | 1         |
| 70 tons   | S7        | 1.7         | 1    | 1         |
| 80 tons   | S8        | 1.8         | 1    | 1         |
| 90 tons   | S9        | 1.9         | 1    | 1         |

Subtract world gravity from the spaceplane's acceleration and divide the listed flight times in the table by that number.

*The CIT-990 Combat Lander has an acceleration of 3G. Tirane has a surface gravity of 0.98G.  $3-0.98=2.02$ . As a lifting body, the base flight time to orbit is four hours. On Tirane it would be 1.98 hours. A spaceplane with only 1G of acceleration, however, would take 200 hours to reach orbit, if it could somehow carry that much fuel.*

### Atmospheric Operation

Airframe Spacecraft can operate in atmosphere much like any other aircraft. Air speed is based on the G-rating of the drive and the hull form.

#### Atmospheric Speed Table

| Hull Type             | Maximum Airspeed | Speed (km/h per G-rating) |
|-----------------------|------------------|---------------------------|
| Standard Airframe     | 5,000 km/h       | 1,000                     |
| Lifting Body Airframe | 2,500 km/h       | 500                       |
| Hybrid Airframe       | 6,000 km/h       | 1,200                     |

*Air-Breathing Rocket:* The Air-breathing rocket is a turbo-scamjet that can switch to pure rocket mode once the air is too thin. It is a common reaction drive for small craft that lack MHD turbines.

*Thruster:* A thruster is a high-efficiency MHD-plasma rocket, designed as an add-on to an MHD turbine. It acts like an afterburner on the high-velocity exhaust of the turbine. While in operation, a thruster-equipped MHD turbine produces only minimal power for life-support and electronics. Vessels operating on thrusters cannot use active sensors or energy weapons unless they have some sort of alternate Power Plant.

A thruster unit requires an MHD turbine (see Power Plants, page 200) and generates thrust based on the power output of the turbine. In addition to the fuel requirements of the turbine itself, a thruster also requires fuel.

Air-breathing thrusters in bypass turbofan mode are very fuel-efficient, the only drawback being size and cost. Air-breathing thrusters use high-bypass turbofans at low speed, scramjets at high-speed/high-altitude and the full magneto-plasma rocket for flight out of the atmosphere.

Thrusters and air-breathing thrusters must have an MHD turbine with a letter rating equal to the rating of the thruster.

*Nuclear Thruster:* A nuclear thruster requires a fission or fusion Power Plant and works by running the reaction mass past (or through) the extremely hot core of the reactor. Radiation is an issue with these drives and so they are rarely seen on civilian landing craft. These drive systems generate Severe to Extreme radiation when in operation and their use for more than a few seconds over a fixed spot will thoroughly irradiate it. Nuclear thrusters must have a fission or fusion power plant with a letter rating equal to the rating of the thruster. Small craft cannot use nuclear thrusters

*SSTO:* The modern Single-Stage To Orbit rocket is a hybrid of several SSTO concepts. It combines a high-efficiency liquid-fuelled engine with a retractable rotor system for take-off and landing. This prevents the sort of landing site damage common with high thrust rockets. The SSTO does not require an additional power plant.

*Ion Drive:* While not common with human vessels, ion drives are still used in long-duration satellite station-keeping thrusters. The Sung also make extensive use of ion drives in their system-ships. An ion drive electromagnetically accelerates a

#### Reaction Drive Table

| Reaction Drive         | Fuel Consumption | Size and Cost Modifier | Maximum ACC | Minimum Letter Rating |
|------------------------|------------------|------------------------|-------------|-----------------------|
| Air-breathing Rocket   | 2.0%             | X0.8                   | 4           | sA                    |
| Thruster               | 2.0%             | X1                     | 6           | A                     |
| Air-breathing Thruster | 1.5%             | X1.2                   | 6           | A                     |
| Nuclear Thruster       | 1.0%             | X2                     | 10          | J                     |
| Solid-fuel Rocket      | 5%               | X0.8                   | 8           | A                     |
| Liquid-fuel Rocket     | 25%              | X1                     | 6           | A                     |
| SSTO Rocket            | 4%               | X1                     | 3           | sA                    |
| Ion Drive              | 0.0025%          | X5                     | 0.01        | sA                    |
| Plasma Drive           | 0.025%           | X5                     | 0.1         | sA                    |

stream of heavy charged particles in order to create thrust. Accelerations are very low but fuel consumption is also, allowing the drives to accelerate for long periods of time. Ion drives must have some sort of Power Plant with a rating equal to the drive rating. Divide ACC values from the Drive Performance table by 100 to arrive at the ion drive vessel's actual acceleration.

*Plasma Drive:* The plasma drive is another high-efficiency design, similar to the VASIMIR designs of the early 21<sup>st</sup> Century, like the one used on the fateful asteroid intercept mission. Plasma drives must have some sort of Power Plant with a rating equal to the drive rating. Divide ACC values from the Drive Performance table by 10 to arrive at the plasma drive vessel's actual acceleration

*Solid Fuel Rockets:* Solid fuel rockets are most often used as boosters and are usually disposable. They do not require additional Power Plants

*Liquid-fuel Rockets:* Liquid-fuel rockets are a simpler method of moving bulk cargos into orbit. They are cheaper to build than most other types of reaction drives, although less efficient and are often disposable. They do not require additional Power Plants

## STUTTERWARP DRIVE

### Stutterwarp

The Jerome-effect stutterwarp is one of the most, if not the most, significant discoveries of the past 300 years. These drives are the main means of transportation between worlds within a system and the only practical method of travel between star systems.

### Small Craft Reaction Drive Table

The results from this table are modified as per the Reaction Drive Table.

|    | Tonnage | MLv |
|----|---------|-----|
| sA | 0.50    | 1   |
| sB | 1.00    | 2   |
| sC | 1.50    | 3   |
| sD | 2.00    | 3.5 |
| sE | 2.50    | 4   |
| sF | 3.00    | 6   |
| sG | 3.50    | 8   |
| A  | 4.00    | 9   |
| B  | 4.50    | 10  |
| C  | 5.00    | 11  |
| D  | 5.50    | 12  |
| E  | 6.00    | 14  |
| F  | 6.50    | 16  |

There are three stutterwarp speeds recorded for all ships: Loaded, unloaded and tactical speed. Design the ship as normal, using the desired stutterwarp speed. Once the design is complete, subtract the space allocated to cargo, embarked small craft and vehicles and fuel and reference this hull size on the appropriate stutterwarp drive performance table. This is the unloaded speed of the ship.

Stutterwarps have a maximum range of 7.7 light years, after which they must discharge their drives in a gravity well. Failure to discharge the drives means risking an inversion event as the

### Small Craft Reaction Drive Performance Table

This table gives acceleration values for hull sizes and reaction drives.

|    | 10   | 20   | 30   | 40   | 50   | 60   | 70   | 80   | 90   |
|----|------|------|------|------|------|------|------|------|------|
| sA | 1.50 | 1.00 | 0.50 | —    | —    | —    | —    | —    | —    |
| sB | 2.00 | 1.50 | 1.00 | 0.50 | —    | —    | —    | —    | —    |
| sC | 2.50 | 2.00 | 1.50 | 1.00 | 0.50 | —    | —    | —    | —    |
| sD | 3.00 | 2.50 | 2.00 | 1.50 | 1.00 | 0.50 | —    | —    | —    |
| sE | 3.50 | 3.00 | 2.50 | 2.00 | 1.50 | 1.00 | 0.50 | —    | —    |
| sF | 4.00 | 3.50 | 3.00 | 2.50 | 2.00 | 1.50 | 1.00 | 0.50 | —    |
| sG | 4.50 | 4.00 | 3.50 | 3.00 | 2.50 | 2.00 | 1.50 | 1.00 | 0.50 |
| A  | 5.00 | 4.50 | 4.00 | 3.50 | 3.00 | 2.50 | 2.00 | 1.50 | 1.00 |
| B  | 5.50 | 5.00 | 4.50 | 4.00 | 3.50 | 3.00 | 2.50 | 2.00 | 1.50 |
| C  | 6.00 | 5.50 | 5.00 | 4.50 | 4.00 | 3.50 | 3.00 | 2.50 | 2.00 |
| D  | 6.50 | 6.00 | 5.50 | 5.00 | 4.50 | 4.00 | 3.50 | 3.00 | 2.50 |
| E  | —    | 6.50 | 6.00 | 5.50 | 5.00 | 4.50 | 4.00 | 3.50 | 3.00 |
| F  | —    | —    | 6.50 | 6.00 | 5.50 | 5.00 | 4.50 | 4.00 | 3.50 |

Tantalum-180 in the drive decomposes to Hafnium. This will destroy the drive and thoroughly irradiate the ship.

**Tactical Speed:** To get the tactical (combat) speed of a starship, multiply the current warp speed by two and round up or down to the nearest whole number. This is the vessel's speed in range bands per turn in starship combat.

To design a stutterwarp, use the Stutterwarp Base Drive Performance table that follows, modified by the appropriate Tech Level. Cross-reference the hull size across the top with the desired stutterwarp speed in the body of the table and then the required drive letter. This drive letter is also equal to the minimum power plant required to achieve the desired performance with that stutterwarp drive.

**Stutterwarp Drive Base Performance Table**

The base performance level for stutterwarp drives is the Old Commercial (TL10) drive. The performance values of the other Tech Levels are based on this table.

**SMALL CRAFT STUTTERWARP PERFORMANCE TABLES, 10-90 TONS**

|    | 10    | 15   | 20   | 25   | 30   | 35   | 40   | 45   | 50   | 55   | 60   | 65   | 70   | 75   | 80   | 85   | 90   | 95   |
|----|-------|------|------|------|------|------|------|------|------|------|------|------|------|------|------|------|------|------|
| sA | 0.74  | 0.65 | 0.59 | 0.55 | 0.52 | 0.49 | 0.47 | 0.45 | 0.44 | 0.42 | 0.41 | 0.40 | 0.39 | 0.38 | 0.37 | 0.36 | 0.36 | 0.35 |
| sB | 0.94  | 0.82 | 0.74 | 0.69 | 0.65 | 0.62 | 0.59 | 0.57 | 0.55 | 0.53 | 0.52 | 0.50 | 0.49 | 0.48 | 0.47 | 0.46 | 0.45 | 0.44 |
| sC | 1.07  | 0.94 | 0.85 | 0.79 | 0.74 | 0.71 | 0.68 | 0.65 | 0.63 | 0.61 | 0.59 | 0.58 | 0.56 | 0.55 | 0.54 | 0.53 | 0.52 | 0.51 |
| sD | 1.18  | 1.03 | 0.94 | 0.87 | 0.82 | 0.78 | 0.74 | 0.72 | 0.69 | 0.67 | 0.65 | 0.63 | 0.62 | 0.60 | 0.59 | 0.58 | 0.57 | 0.56 |
| sE | 1.27  | 1.11 | 1.01 | 0.94 | 0.88 | 0.84 | 0.80 | 0.77 | 0.74 | 0.72 | 0.70 | 0.68 | 0.67 | 0.65 | 0.64 | 0.62 | 0.61 | 0.60 |
| sF | 1.35  | 1.18 | 1.07 | 1.00 | 0.94 | 0.89 | 0.85 | 0.82 | 0.79 | 0.77 | 0.74 | 0.72 | 0.71 | 0.69 | 0.68 | 0.66 | 0.65 | 0.64 |
| sG | 1.42  | 1.24 | 1.13 | 1.05 | 0.99 | 0.94 | 0.90 | 0.86 | 0.83 | 0.81 | 0.78 | 0.76 | 0.74 | 0.73 | 0.71 | 0.70 | 0.68 | 0.67 |
| sH | 1.49  | 1.30 | 1.18 | 1.10 | 1.03 | 0.98 | 0.94 | 0.90 | 0.87 | 0.84 | 0.82 | 0.80 | 0.78 | 0.76 | 0.74 | 0.73 | 0.72 | 0.70 |
| sJ | 1.55  | 1.35 | 1.23 | 1.14 | 1.07 | 1.02 | 0.98 | 0.94 | 0.91 | 0.88 | 0.85 | 0.83 | 0.81 | 0.79 | 0.77 | 0.76 | 0.74 | 0.73 |
| sK | 1.60  | 1.40 | 1.27 | 1.18 | 1.11 | 1.06 | 1.01 | 0.97 | 0.94 | 0.91 | 0.88 | 0.86 | 0.84 | 0.82 | 0.80 | 0.79 | 0.77 | 0.76 |
| sL | 2.02  | 1.76 | 1.60 | 1.49 | 1.40 | 1.33 | 1.27 | 1.22 | 1.18 | 1.14 | 1.11 | 1.08 | 1.06 | 1.03 | 1.01 | 0.99 | 0.97 | 0.95 |
| sM | 2.31  | 2.02 | 1.84 | 1.70 | 1.60 | 1.52 | 1.46 | 1.40 | 1.35 | 1.31 | 1.27 | 1.24 | 1.21 | 1.18 | 1.16 | 1.13 | 1.11 | 1.09 |
| sN | 2.54  | 2.22 | 2.02 | 1.88 | 1.76 | 1.68 | 1.60 | 1.54 | 1.49 | 1.44 | 1.40 | 1.36 | 1.33 | 1.30 | 1.27 | 1.25 | 1.22 | 1.20 |
| A  | 2.74  | 2.39 | 2.18 | 2.02 | 1.90 | 1.81 | 1.73 | 1.66 | 1.60 | 1.55 | 1.51 | 1.47 | 1.43 | 1.40 | 1.37 | 1.34 | 1.32 | 1.29 |
| B  | 2.91  | 2.54 | 2.31 | 2.15 | 2.02 | 1.92 | 1.84 | 1.76 | 1.70 | 1.65 | 1.60 | 1.56 | 1.52 | 1.49 | 1.46 | 1.43 | 1.40 | 1.38 |
| C  | 3.07  | 2.68 | 2.43 | 2.26 | 2.13 | 2.02 | 1.93 | 1.86 | 1.79 | 1.74 | 1.69 | 1.64 | 1.60 | 1.57 | 1.53 | 1.50 | 1.47 | 1.45 |
| D  | 3.21  | 2.80 | 2.54 | 2.36 | 2.22 | 2.11 | 2.02 | 1.94 | 1.88 | 1.82 | 1.76 | 1.72 | 1.68 | 1.64 | 1.60 | 1.57 | 1.54 | 1.51 |
| E  | 3.33  | 2.91 | 2.65 | 2.46 | 2.31 | 2.20 | 2.10 | 2.02 | 1.95 | 1.89 | 1.84 | 1.79 | 1.74 | 1.70 | 1.67 | 1.63 | 1.60 | 1.57 |
| F  | 3.45  | 3.02 | 2.74 | 2.54 | 2.39 | 2.27 | 2.18 | 2.09 | 2.02 | 1.96 | 1.90 | 1.85 | 1.81 | 1.76 | 1.73 | 1.69 | 1.66 | 1.63 |
| G  | 4.35  | 3.80 | 3.45 | 3.21 | 3.02 | 2.87 | 2.74 | 2.64 | 2.54 | 2.47 | 2.39 | 2.33 | 2.27 | 2.22 | 2.18 | 2.13 | 2.09 | 2.05 |
| H  | 4.98  | 4.35 | 3.95 | 3.67 | 3.45 | 3.28 | 3.14 | 3.02 | 2.91 | 2.82 | 2.74 | 2.67 | 2.60 | 2.54 | 2.49 | 2.44 | 2.39 | 2.35 |
| J  | 5.48  | 4.79 | 4.35 | 4.04 | 3.80 | 3.61 | 3.45 | 3.32 | 3.21 | 3.11 | 3.02 | 2.94 | 2.87 | 2.80 | 2.74 | 2.69 | 2.64 | 2.59 |
| K  | 5.91  | 5.16 | 4.69 | 4.35 | 4.10 | 3.89 | 3.72 | 3.58 | 3.45 | 3.35 | 3.25 | 3.16 | 3.09 | 3.02 | 2.95 | 2.89 | 2.84 | 2.79 |
| L  | 7.44  | 6.50 | 5.91 | 5.48 | 5.16 | 4.90 | 4.69 | 4.51 | 4.35 | 4.22 | 4.10 | 3.99 | 3.89 | 3.80 | 3.72 | 3.65 | 3.58 | 3.51 |
| M  | 8.52  | 7.44 | 6.76 | 6.28 | 5.91 | 5.61 | 5.37 | 5.16 | 4.98 | 4.83 | 4.69 | 4.56 | 4.45 | 4.35 | 4.26 | 4.17 | 4.10 | 4.02 |
| N  | 9.38  | 8.19 | 7.44 | 6.91 | 6.50 | 6.17 | 5.91 | 5.68 | 5.48 | 5.31 | 5.16 | 5.02 | 4.90 | 4.79 | 4.69 | 4.59 | 4.51 | 4.43 |
| P  | 10.10 | 8.82 | 8.02 | 7.44 | 7.00 | 6.65 | 6.36 | 6.12 | 5.91 | 5.72 | 5.56 | 5.41 | 5.28 | 5.16 | 5.05 | 4.95 | 4.86 | 4.77 |

**STUTTERWARP PERFORMANCE TABLE, HULLS SIZES 100-1,000 TONS**

| Drive Rating | 100   | 150  | 200  | 250  | 300  | 350  | 400  | 450  | 500  | 550  | 600  | 650  | 700  | 750  | 800  | 850  | 900  | 950  | 1,000 |
|--------------|-------|------|------|------|------|------|------|------|------|------|------|------|------|------|------|------|------|------|-------|
| A            | 1.27  | 1.11 | 1.01 | 0.94 | 0.88 | 0.84 | 0.80 | 0.77 | 0.74 | 0.72 | 0.70 | 0.68 | 0.67 | 0.65 | 0.64 | 0.62 | 0.61 | 0.60 | 0.59  |
| B            | 1.35  | 1.18 | 1.07 | 1.00 | 0.94 | 0.89 | 0.85 | 0.82 | 0.79 | 0.77 | 0.74 | 0.72 | 0.71 | 0.69 | 0.68 | 0.66 | 0.65 | 0.64 | 0.63  |
| C            | 1.42  | 1.24 | 1.13 | 1.05 | 0.99 | 0.94 | 0.90 | 0.86 | 0.83 | 0.81 | 0.78 | 0.76 | 0.74 | 0.73 | 0.71 | 0.70 | 0.68 | 0.67 | 0.66  |
| D            | 1.49  | 1.30 | 1.18 | 1.10 | 1.03 | 0.98 | 0.94 | 0.90 | 0.87 | 0.84 | 0.82 | 0.80 | 0.78 | 0.76 | 0.74 | 0.73 | 0.72 | 0.70 | 0.69  |
| E            | 1.55  | 1.35 | 1.23 | 1.14 | 1.07 | 1.02 | 0.98 | 0.94 | 0.91 | 0.88 | 0.85 | 0.83 | 0.81 | 0.79 | 0.77 | 0.76 | 0.74 | 0.73 | 0.72  |
| F            | 1.60  | 1.40 | 1.27 | 1.18 | 1.11 | 1.06 | 1.01 | 0.97 | 0.94 | 0.91 | 0.88 | 0.86 | 0.84 | 0.82 | 0.80 | 0.79 | 0.77 | 0.76 | 0.74  |
| G            | 2.02  | 1.76 | 1.60 | 1.49 | 1.40 | 1.33 | 1.27 | 1.22 | 1.18 | 1.14 | 1.11 | 1.08 | 1.06 | 1.03 | 1.01 | 0.99 | 0.97 | 0.95 | 0.94  |
| H            | 2.31  | 2.02 | 1.84 | 1.70 | 1.60 | 1.52 | 1.46 | 1.40 | 1.35 | 1.31 | 1.27 | 1.24 | 1.21 | 1.18 | 1.16 | 1.13 | 1.11 | 1.09 | 1.07  |
| J            | 2.54  | 2.22 | 2.02 | 1.88 | 1.76 | 1.68 | 1.60 | 1.54 | 1.49 | 1.44 | 1.40 | 1.36 | 1.33 | 1.30 | 1.27 | 1.25 | 1.22 | 1.20 | 1.18  |
| K            | 2.74  | 2.39 | 2.18 | 2.02 | 1.90 | 1.81 | 1.73 | 1.66 | 1.60 | 1.55 | 1.51 | 1.47 | 1.43 | 1.40 | 1.37 | 1.34 | 1.32 | 1.29 | 1.27  |
| L            | 3.45  | 3.02 | 2.74 | 2.54 | 2.39 | 2.27 | 2.18 | 2.09 | 2.02 | 1.96 | 1.90 | 1.85 | 1.81 | 1.76 | 1.73 | 1.69 | 1.66 | 1.63 | 1.60  |
| M            | 3.95  | 3.45 | 3.14 | 2.91 | 2.74 | 2.60 | 2.49 | 2.39 | 2.31 | 2.24 | 2.18 | 2.12 | 2.07 | 2.02 | 1.98 | 1.94 | 1.90 | 1.87 | 1.84  |
| N            | 4.35  | 3.80 | 3.45 | 3.21 | 3.02 | 2.87 | 2.74 | 2.64 | 2.54 | 2.47 | 2.39 | 2.33 | 2.27 | 2.22 | 2.18 | 2.13 | 2.09 | 2.05 | 2.02  |
| P            | 4.69  | 4.10 | 3.72 | 3.45 | 3.25 | 3.09 | 2.95 | 2.84 | 2.74 | 2.66 | 2.58 | 2.51 | 2.45 | 2.39 | 2.34 | 2.30 | 2.25 | 2.21 | 2.18  |
| Q            | 5.91  | 5.16 | 4.69 | 4.35 | 4.10 | 3.89 | 3.72 | 3.58 | 3.45 | 3.35 | 3.25 | 3.16 | 3.09 | 3.02 | 2.95 | 2.89 | 2.84 | 2.79 | 2.74  |
| R            | 6.76  | 5.91 | 5.37 | 4.98 | 4.69 | 4.45 | 4.26 | 4.10 | 3.95 | 3.83 | 3.72 | 3.62 | 3.53 | 3.45 | 3.38 | 3.31 | 3.25 | 3.19 | 3.14  |
| S            | 7.44  | 6.50 | 5.91 | 5.48 | 5.16 | 4.90 | 4.69 | 4.51 | 4.35 | 4.22 | 4.10 | 3.99 | 3.89 | 3.80 | 3.72 | 3.65 | 3.58 | 3.51 | 3.45  |
| T            | 7.91  | 6.91 | 6.28 | 5.83 | 5.48 | 5.21 | 4.98 | 4.79 | 4.62 | 4.48 | 4.35 | 4.24 | 4.13 | 4.04 | 3.95 | 3.87 | 3.80 | 3.73 | 3.67  |
| U            | 8.32  | 7.27 | 6.61 | 6.13 | 5.77 | 5.48 | 5.24 | 5.04 | 4.87 | 4.72 | 4.58 | 4.46 | 4.35 | 4.25 | 4.16 | 4.08 | 4.00 | 3.93 | 3.86  |
| V            | 8.70  | 7.60 | 6.91 | 6.41 | 6.03 | 5.73 | 5.48 | 5.27 | 5.09 | 4.93 | 4.79 | 4.66 | 4.55 | 4.45 | 4.35 | 4.26 | 4.18 | 4.11 | 4.04  |
| W            | 9.05  | 7.91 | 7.18 | 6.67 | 6.28 | 5.96 | 5.70 | 5.48 | 5.29 | 5.13 | 4.98 | 4.85 | 4.73 | 4.62 | 4.53 | 4.44 | 4.35 | 4.27 | 4.20  |
| X            | 9.38  | 8.19 | 7.44 | 6.91 | 6.50 | 6.17 | 5.91 | 5.68 | 5.48 | 5.31 | 5.16 | 5.02 | 4.90 | 4.79 | 4.69 | 4.59 | 4.51 | 4.43 | 4.35  |
| Y            | 10.10 | 8.82 | 8.02 | 7.44 | 7.00 | 6.65 | 6.36 | 6.12 | 5.91 | 5.72 | 5.56 | 5.41 | 5.28 | 5.16 | 5.05 | 4.95 | 4.86 | 4.77 | 4.69  |
| Z            | 10.73 | 9.38 | 8.52 | 7.91 | 7.44 | 7.07 | 6.76 | 6.50 | 6.28 | 6.08 | 5.91 | 5.75 | 5.61 | 5.48 | 5.37 | 5.26 | 5.16 | 5.07 | 4.98  |

**STUTTERWARP PERFORMANCE TABLE, HULLS SIZES 1,001-10,000 TONS**

| Drive Rating | 1,100 | 1,200 | 1,300 | 1,400 | 1,500 | 2,000 | 2,500 | 3,000 | 3,500 | 4,000 | 4,500 | 5,000 | 7,500 | 10,000 |
|--------------|-------|-------|-------|-------|-------|-------|-------|-------|-------|-------|-------|-------|-------|--------|
| A            | 0.57  | 0.56  | 0.54  | 0.53  | 0.52  | 0.47  | 0.44  | 0.41  | 0.39  | 0.37  | 0.36  | 0.35  | 0.30  | 0.27   |
| B            | 0.61  | 0.59  | 0.58  | 0.56  | 0.55  | 0.50  | 0.46  | 0.44  | 0.41  | 0.40  | 0.38  | 0.37  | 0.32  | 0.29   |
| C            | 0.64  | 0.62  | 0.61  | 0.59  | 0.58  | 0.52  | 0.49  | 0.46  | 0.44  | 0.42  | 0.40  | 0.39  | 0.34  | 0.31   |
| D            | 0.67  | 0.65  | 0.63  | 0.62  | 0.60  | 0.55  | 0.51  | 0.48  | 0.46  | 0.44  | 0.42  | 0.40  | 0.35  | 0.32   |
| E            | 0.70  | 0.68  | 0.66  | 0.64  | 0.63  | 0.57  | 0.53  | 0.50  | 0.47  | 0.45  | 0.44  | 0.42  | 0.37  | 0.33   |
| F            | 0.72  | 0.70  | 0.68  | 0.67  | 0.65  | 0.59  | 0.55  | 0.52  | 0.49  | 0.47  | 0.45  | 0.44  | 0.38  | 0.35   |
| G            | 0.91  | 0.88  | 0.86  | 0.84  | 0.82  | 0.74  | 0.69  | 0.65  | 0.62  | 0.59  | 0.57  | 0.55  | 0.48  | 0.44   |
| H            | 1.04  | 1.01  | 0.98  | 0.96  | 0.94  | 0.85  | 0.79  | 0.74  | 0.71  | 0.68  | 0.65  | 0.63  | 0.55  | 0.50   |
| J            | 1.14  | 1.11  | 1.08  | 1.06  | 1.03  | 0.94  | 0.87  | 0.82  | 0.78  | 0.74  | 0.72  | 0.69  | 0.60  | 0.55   |
| K            | 1.23  | 1.20  | 1.17  | 1.14  | 1.11  | 1.01  | 0.94  | 0.88  | 0.84  | 0.80  | 0.77  | 0.74  | 0.65  | 0.59   |
| L            | 1.55  | 1.51  | 1.47  | 1.43  | 1.40  | 1.27  | 1.18  | 1.11  | 1.06  | 1.01  | 0.97  | 0.94  | 0.82  | 0.74   |
| M            | 1.78  | 1.73  | 1.68  | 1.64  | 1.60  | 1.46  | 1.35  | 1.27  | 1.21  | 1.16  | 1.11  | 1.07  | 0.94  | 0.85   |
| N            | 1.96  | 1.90  | 1.85  | 1.81  | 1.76  | 1.60  | 1.49  | 1.40  | 1.33  | 1.27  | 1.22  | 1.18  | 1.03  | 0.94   |
| P            | 2.11  | 2.05  | 1.99  | 1.95  | 1.90  | 1.73  | 1.60  | 1.51  | 1.43  | 1.37  | 1.32  | 1.27  | 1.11  | 1.01   |
| Q            | 2.66  | 2.58  | 2.51  | 2.45  | 2.39  | 2.18  | 2.02  | 1.90  | 1.81  | 1.73  | 1.66  | 1.60  | 1.40  | 1.27   |

|   |      |      |      |      |      |      |      |      |      |      |      |      |      |      |
|---|------|------|------|------|------|------|------|------|------|------|------|------|------|------|
| R | 3.04 | 2.95 | 2.88 | 2.81 | 2.74 | 2.49 | 2.31 | 2.18 | 2.07 | 1.98 | 1.90 | 1.84 | 1.60 | 1.46 |
| S | 3.35 | 3.25 | 3.16 | 3.09 | 3.02 | 2.74 | 2.54 | 2.39 | 2.27 | 2.18 | 2.09 | 2.02 | 1.76 | 1.60 |
| T | 3.56 | 3.45 | 3.36 | 3.28 | 3.21 | 2.91 | 2.70 | 2.54 | 2.42 | 2.31 | 2.22 | 2.15 | 1.88 | 1.70 |
| U | 3.74 | 3.64 | 3.54 | 3.45 | 3.38 | 3.07 | 2.85 | 2.68 | 2.54 | 2.43 | 2.34 | 2.26 | 1.97 | 1.79 |
| V | 3.91 | 3.80 | 3.70 | 3.61 | 3.53 | 3.21 | 2.98 | 2.80 | 2.66 | 2.54 | 2.45 | 2.36 | 2.06 | 1.88 |
| W | 4.07 | 3.95 | 3.85 | 3.76 | 3.67 | 3.33 | 3.10 | 2.91 | 2.77 | 2.65 | 2.54 | 2.46 | 2.15 | 1.95 |
| X | 4.22 | 4.10 | 3.99 | 3.89 | 3.80 | 3.45 | 3.21 | 3.02 | 2.87 | 2.74 | 2.64 | 2.54 | 2.22 | 2.02 |
| Y | 4.54 | 4.41 | 4.30 | 4.19 | 4.10 | 3.72 | 3.45 | 3.25 | 3.09 | 2.95 | 2.84 | 2.74 | 2.39 | 2.18 |
| Z | 4.83 | 4.69 | 4.56 | 4.45 | 4.35 | 3.95 | 3.67 | 3.45 | 3.28 | 3.14 | 3.02 | 2.91 | 2.54 | 2.31 |

## TECH LEVEL ADJUSTMENTS

*New Commercial / Old Military (TL11) Stutterwarp Drives:* New commercial drives are the cutting edge for merchant vessels and also represents older military designs.

Multiply the stutterwarp speed from the Base Drive Performance Table by 1.07 to arrive at the New Commercial Stutterwarp Speed.

*New Military (TL12) Stutterwarp Drives:* New Military stutterwarp drives are the fastest and most efficient drives built.

Multiply the stutterwarp speed from the Base Drive Performance Table by 1.15 to arrive at the New Military Stutterwarp Speed.

## Stutterwarp Drives

Match the stutterwarp drive required from the appropriate of the previous tables. The drive types marked with an 's' are typically small craft and remote object drives.

## STUTTERWARP DRIVE TABLE

| Drive Rating | Old Commercial |            | New Commercial |            | New Military |            |
|--------------|----------------|------------|----------------|------------|--------------|------------|
|              | Size (Tons)    | Cost (MLv) | Size (Tons)    | Cost (MLv) | Size (Tons)  | Cost (MLv) |
| sA           | 0.18           | 0.54       | 0.21           | 0.62       | 0.25         | 0.75       |
| sB           | 0.19           | 0.58       | 0.23           | 0.68       | 0.27         | 0.81       |
| sC           | 0.20           | 0.62       | 0.24           | 0.72       | 0.29         | 0.86       |
| sD           | 0.21           | 0.64       | 0.25           | 0.75       | 0.30         | 0.90       |
| sE           | 0.22           | 0.67       | 0.26           | 0.78       | 0.31         | 0.94       |
| sF           | 0.23           | 0.69       | 0.27           | 0.81       | 0.32         | 0.97       |
| sG           | 0.24           | 0.71       | 0.28           | 0.83       | 0.33         | 1.00       |
| sH           | 0.24           | 0.73       | 0.29           | 0.86       | 0.34         | 1.02       |
| sJ           | 0.25           | 0.75       | 0.29           | 0.88       | 0.35         | 1.05       |
| sK           | 0.26           | 0.77       | 0.30           | 0.89       | 0.36         | 1.07       |
| sL           | 0.30           | 0.91       | 0.35           | 1.06       | 0.42         | 1.27       |
| sM           | 0.34           | 1.01       | 0.40           | 1.19       | 0.47         | 1.42       |
| sN           | 0.37           | 1.11       | 0.43           | 1.29       | 0.52         | 1.55       |
| A            | 0.40           | 1.19       | 0.46           | 1.38       | 0.55         | 1.66       |
| B            | 0.42           | 1.26       | 0.49           | 1.47       | 0.59         | 1.76       |
| C            | 0.44           | 1.33       | 0.52           | 1.55       | 0.62         | 1.85       |
| D            | 0.46           | 1.39       | 0.54           | 1.62       | 0.65         | 1.94       |
| E            | 0.48           | 1.45       | 0.56           | 1.69       | 0.67         | 2.02       |
| F            | 0.50           | 1.50       | 0.58           | 1.75       | 0.70         | 2.10       |



|   |      |       |      |       |      |       |
|---|------|-------|------|-------|------|-------|
| G | 0.65 | 1.94  | 0.76 | 2.27  | 0.91 | 2.72  |
| H | 0.76 | 2.28  | 0.89 | 2.66  | 1.07 | 3.20  |
| J | 0.86 | 2.57  | 1.00 | 3.00  | 1.20 | 3.60  |
| K | 0.94 | 2.82  | 1.10 | 3.29  | 1.32 | 3.95  |
| L | 1.27 | 3.82  | 1.48 | 4.45  | 1.78 | 5.34  |
| M | 1.53 | 4.58  | 1.78 | 5.34  | 2.14 | 6.41  |
| N | 1.74 | 5.22  | 2.03 | 6.09  | 2.44 | 7.31  |
| P | 1.93 | 5.79  | 2.25 | 6.75  | 2.70 | 8.10  |
| Q | 2.67 | 8.00  | 3.11 | 9.34  | 3.74 | 11.21 |
| R | 3.24 | 9.71  | 3.78 | 11.33 | 4.53 | 13.59 |
| S | 3.71 | 11.14 | 4.33 | 13.00 | 5.20 | 15.60 |
| T | 4.06 | 12.17 | 4.73 | 14.19 | 5.68 | 17.03 |
| U | 4.37 | 13.11 | 5.10 | 15.29 | 6.12 | 18.35 |
| V | 4.66 | 13.98 | 5.44 | 16.31 | 6.52 | 19.58 |
| W | 4.93 | 14.80 | 5.76 | 17.27 | 6.91 | 20.72 |
| X | 5.19 | 15.58 | 6.06 | 18.18 | 7.27 | 21.81 |
| Y | 5.79 | 17.37 | 6.76 | 20.27 | 8.11 | 24.32 |
| Z | 6.33 | 18.99 | 7.38 | 22.15 | 8.86 | 26.58 |

## POWER PLANTS

Choose a Power Plant based on the capabilities you want for a vessel. Any trans-atmospheric vessel will usually mount an MHD turbine for a power system, as the thruster can be added to it.

Small craft with less than six hours duration do not require a Power Plant, instead relying on batteries and generators powered from the drive system.

A Power Plant of equal letter rating to the stutterwarp drive or manoeuvre drive must be installed, whichever is higher.

With Fuel cells, MHD turbines and fission reactors, it is possible to run the Power Plant and drive at lower ratings. This will improve endurance at the expense of speed. Select a lower rated drive and use the performance and fuel consumption figures from the lower rated drives. Fusion reactors, however, cannot be throttled back.

If a vessel's Power Plant is equal to the stutterwarp letter rating, then the spacecraft can move at full speed but cannot use active sensors, fire energy weapons. If the speed is reduced by 25%, then it can move and either use active sensors or fire energy weapons but not both. If the vessel moves at 50%, then it can use active sensors and fire energy weapons.

If the Power Plant is one letter higher than the stutterwarp drive, then the vessel can move at full speed and either use

active sensors or fire energy weapons but not both. If the ship drops speed by 25%, then it can move and use active sensors and fire energy weapons.

If the Power Plant rating is two letters higher than the stutterwarp drive, then it can move at full speed, use active sensors and fire energy weapons.

In any case, power plants smaller than 'A' cannot be used to power energy weapons, no matter how many steps they are over the base requirement.

*Waste Heat:* In space, every component of a ship produces heat, from the Power Plant to the weapons to the crew. The vacuum of space is a perfect insulator and the only way a ship has to shed the heat is through hull-mounted radiators. Failure to get rid of the heat results in a slow cooking of the ship and its crew. All spacecraft must install radiators and heat sinks to disperse this excess heat. Radiators take up space equal to 10% of the size of the Power Plant and cost Lv50,000 per ton. They have a letter rating identical to the power plant they service.

Damage to radiators in combat will force the choice of lowering power output or cooking the ship.

If larger than necessary radiators are installed, then this will affect the vessel's signature. For each letter category higher or installed radiators vs. drive letter rating, there is an additional -1 DM to detection from Passive Sensors. At the same time, there will be an additional +1 to detection from Active Sensors.

## Secondary Power Plants

Some vessels may carry secondary Power Plants, typically for use during combat or in very large vessels. Any Power Plant may be used as a secondary. Using the Performance by Hull Volume table from page 108 the *Traveller Core Rulebook*, find the letter rating of a drive sufficient to give the hull a 1G acceleration. Using that drive letter, choose a Power Plant from the tables in this section. Ensure that appropriately-sized radiators are included and add fuel, probably for no more than 12 hours of operation.

## SECONDARY POWER PLANTS

| Size  | Secondary Power Plant | Size   | Secondary Power Plant |
|-------|-----------------------|--------|-----------------------|
| 2,500 | L                     | 6,000  | S                     |
| 3,000 | M                     | 7,000  | T                     |
| 3,500 | N                     | 8,000  | U                     |
| 4,000 | P                     | 9,000  | V                     |
| 4,500 | Q                     | 10,000 | W                     |
| 5,000 | R                     |        |                       |

For vessels over 2,000 tons that require secondary power plants, use the following table to determine power plant type.

## Power Plant Types

**Fuel Cells:** Fuel cells are used for low-power applications and backup systems. Although they are low-power, they are compact and easy on fuel. An advantage of fuel cells is that they can be made into a closed system for an additional 5% of cost and volume. In this way, they recover the water exhaust from the fuel cell and once in a target solar system they can deploy a solar array to crack the water back into hydrogen and oxygen fuel. Some long-range exploration vessels make use of this technology.

## Fuel Cell Table

|            | OC          |            | NC          |            | NM          |            | Fuel Consumption |
|------------|-------------|------------|-------------|------------|-------------|------------|------------------|
| Fuel Cells | Size (Tons) | Cost (MLv) | Size (Tons) | Cost (MLv) | Size (Tons) | Cost (MLv) | per hour         |
| sA         | 0.02        | 0.10       | 0.01        | 0.20       | 0.01        | 0.40       | 0.0005           |
| sB         | 0.05        | 0.20       | 0.03        | 0.40       | 0.02        | 0.80       | 0.0011           |
| sC         | 0.07        | 0.30       | 0.04        | 0.60       | 0.03        | 1.20       | 0.0016           |
| sD         | 0.10        | 0.40       | 0.06        | 0.80       | 0.04        | 1.60       | 0.0021           |
| sE         | 0.12        | 0.50       | 0.07        | 1.00       | 0.05        | 2.00       | 0.0027           |
| sF         | 0.14        | 0.60       | 0.09        | 1.20       | 0.06        | 2.40       | 0.0032           |
| sG         | 0.17        | 0.70       | 0.10        | 1.40       | 0.08        | 2.80       | 0.0037           |
| sH         | 0.19        | 0.80       | 0.11        | 1.60       | 0.09        | 3.20       | 0.0042           |
| sJ         | 0.21        | 0.90       | 0.13        | 1.80       | 0.10        | 3.60       | 0.0048           |
| sK         | 0.24        | 1.00       | 0.14        | 2.00       | 0.11        | 4.00       | 0.0053           |
| sL         | 0.48        | 2.00       | 0.29        | 4.00       | 0.21        | 8.00       | 0.0106           |
| sM         | 0.71        | 3.00       | 0.43        | 6.00       | 0.32        | 12.00      | 0.0159           |
| sN         | 0.95        | 4.00       | 0.57        | 8.00       | 0.43        | 16.00      | 0.0212           |
| A          | 1.19        | 5.00       | 0.71        | 10.00      | 0.54        | 20.00      | 0.0265           |
| B          | 1.43        | 6.00       | 0.86        | 12.00      | 0.64        | 24.00      | 0.0318           |
| C          | 1.67        | 7.00       | 1.00        | 14.00      | 0.75        | 28.00      | 0.0371           |
| D          | 1.90        | 8.00       | 1.14        | 16.00      | 0.86        | 32.00      | 0.0424           |
| E          | 2.14        | 9.00       | 1.29        | 18.00      | 0.96        | 36.00      | 0.0477           |
| F          | 2.38        | 10.00      | 1.43        | 20.00      | 1.07        | 40.00      | 0.0530           |
| G          | 4.76        | 20.00      | 2.86        | 40.00      | 2.14        | 80.00      | 0.1061           |
| H          | 7.14        | 30.00      | 4.29        | 60.00      | 3.21        | 120.00     | 0.1591           |
| J          | 9.51        | 40.00      | 5.71        | 80.00      | 4.29        | 160.00     | 0.2121           |

*Magnetohydrodynamic (MHD) Turbines:* The MHD turbine is a method of direct electrical conversion, using the hot exhaust of a turbine to generate a current by seeding the exhaust with charged particles. The movement of the exhaust through a set of coils creates a current.

**MHD Turbine Table**

| MHD Turbine | OC          |            | NC          |            | NM          |            | Fuel                    |
|-------------|-------------|------------|-------------|------------|-------------|------------|-------------------------|
|             | Size (Tons) | Cost (MLv) | Size (Tons) | Cost (MLv) | Size (Tons) | Cost (MLv) | Consumption (tons/hour) |
| A           | 0.71        | 0.06       | 0.48        | 0.10       | 0.36        | 0.13       | 0.035                   |
| B           | 0.86        | 0.08       | 0.57        | 0.12       | 0.43        | 0.15       | 0.040                   |
| C           | 1.00        | 0.09       | 0.67        | 0.14       | 0.50        | 0.18       | 0.050                   |
| D           | 1.14        | 0.10       | 0.76        | 0.16       | 0.57        | 0.20       | 0.055                   |
| E           | 1.29        | 0.11       | 0.86        | 0.18       | 0.64        | 0.23       | 0.065                   |
| F           | 1.43        | 0.13       | 0.95        | 0.20       | 0.71        | 0.25       | 0.070                   |
| G           | 2.86        | 0.25       | 1.90        | 0.40       | 1.43        | 0.50       | 0.140                   |
| H           | 4.29        | 0.38       | 2.86        | 0.60       | 2.14        | 0.75       | 0.210                   |
| J           | 5.71        | 0.50       | 3.81        | 0.80       | 2.86        | 1.00       | 0.280                   |
| K           | 7.14        | 0.63       | 4.76        | 1.00       | 3.57        | 1.25       | 0.35                    |
| L           | 14.29       | 1.25       | 9.52        | 2.00       | 7.14        | 2.50       | 0.700                   |
| M           | 21.43       | 1.88       | 14.29       | 3.00       | 10.71       | 3.75       | 1.10                    |
| N           | 28.57       | 2.50       | 19.05       | 4.00       | 14.29       | 5.00       | 1.4                     |
| P           | 35.71       | 3.13       | 23.81       | 5.00       | 17.86       | 6.25       | 1.8                     |
| Q           | 71.43       | 6.25       | 47.62       | 10.00      | 35.71       | 12.50      | 3.5                     |
| R           | 107.14      | 9.38       | 71.43       | 15.00      | 53.57       | 18.75      | 5.5                     |
| S           | 142.86      | 12.50      | 95.24       | 20.00      | 71.43       | 25.00      | 7.0                     |

*Fusion Reactors:* Utilising the Deuterium-Helium-3 fusion reaction, modern fusion reactors are fairly compact and quite safe, although the engineering overhead on them does limit the lower end of their size. The fuel module for these reactors is sealed and the supply of He-3 fuel is designed to last the life of the reactor, which is rated at 25 years. Fusion Reactors are available to the military at TL 11 and civilians at TL12.

**Fusion Reactor Table**

| Power Plant Rating | Size (Tons) | Cost (MLv) |
|--------------------|-------------|------------|
| U                  | 350         | 80         |
| V                  | 390         | 130        |
| W                  | 430         | 180        |
| X                  | 465         | 200        |
| Y                  | 570         | 300        |
| Z                  | 715         | 400        |

*Fission Reactors:* Modern fission reactors are built with sealed fuel modules, which are designed to last about five years. Fission plants are relatively inexpensive for their power output but

are quite large and require larger crews than other Power Plants. Fission reactors are available to the military at TL 10 and civilians at TL 11.

**Fission Reactor Table**

| Fission Reactor | Size (Tons) | Cost (MLv) |
|-----------------|-------------|------------|
| M               | 70          | 8.00       |
| N               | 90          | 12.00      |
| P               | 110         | 16.00      |
| Q               | 210         | 32.00      |
| R               | 360         | 40.00      |
| S               | 465         | 48.00      |
| T               | 570         | 60.00      |
| U               | 640         | 70.00      |
| V               | 700         | 78.00      |
| W               | 850         | 84.00      |
| X               | 900         | 90.00      |
| Y               | 1100        | 102.00     |
| Z               | 1400        | 140.00     |

**Solar Panel:** Extendable solar panels provide backup power for vessel's Power Plants. They are sometimes installed in scout or mining ships, giving them greater range and endurance. The size of solar panels required to power a ship is 1/10 that of the main Power Plant, to a minimum of half a ton. If the panels are fitted to a ship without a Power Plant, then assume the (non-existent) main Power Plant is sized to deliver a performance rating of 1. A ship equipped with solar panels consumes Power Plant fuel at one-quarter the normal rate as long as it is only engaged in minimal stutterwarp manoeuvring and does not fire energy weapons or use active sensors. Minimal manoeuvring does not include long periods at full stutterwarp speed, so solar panels are useless for trade vessels. If a vessel is not manoeuvring at all, then the primary Power Plant can be set to stand-by mode and the vessel run entirely from the solar panel.

Solar panels cost MLv0.1 per ton. No Power Plant fuel is consumed and endurance is considered as infinite, if the ship is not manoeuvring, using active sensors or refining fuel for use.

*For example, a mining ship has Fuel Cell D, which takes up 1.9 tons. Adding solar panels would consume 0.19 tons (one-tenth of 1.9) and allow the lab ship to go for eight weeks between Power Plant refuelling, as long as the ship was only engaged in light survey work.*

**Chemical Batteries:** The sizes of chemical batteries are based on the Power Plant required to deliver a performance rating of 1. A chemical battery the same size as an MHD turbine of the same Tech Level will provide 10 hours of use assuming the vessel is not manoeuvring, using active sensors, refining fuel, making significant use of long-range communicators or energy-using weapons (such as lasers, rail guns and particle beams).

Alternatively, the same sized battery will give 30 minutes (five Combat Rounds) of performance without these restrictions. A battery can be scaled in size to give any endurance and costs four times the equivalent MHD turbine Power Plant.

Batteries cannot be used to power MHD thrusters but can be used for plasma and ion drives

For example, a TL7 B-rated battery with 200 hours of endurance will require (7 x 200/1,000) 14 tons and cost MLv (16 x 200/100 x 4) 108.

The time to recharge a battery is equivalent to the battery endurance used (in low power setting) divided by 100 then multiplied by two. If using solar panels to recharge the battery, the 'Power Plant Rating' is 0.1. *For example, the battery described previously has been used for 160 hours. To recharge it with solar panels will require (160 /100/0.1 x2) = 32 hours.*

## FUEL

Fuel requirements are based on the desired capabilities of the vessel and what kind of Power Plant it has. Thruster fuel is dealt with in that section. The various tables for the Power Plants list their fuel consumption in hours. Multiply this by 24 to get the fuel requirement per day and use that to determine the vessel's endurance. Fusion and fission reactors, along with solar panels and batteries, do not require fuel.

Note that, unlike in the *Traveller Core Rulebook*, fuel cannot be skimmed from gas giants. Fuel can, however, be extracted from water or ice via solar-powered fuel processors.

Fuel must also be allocated for reaction drives. Note that the fuel for ion drives is completely different from all other drive types. Thrusters, rockets and SSTOs use a hydrogen/oxygen or kerosene/oxygen mix, while nuclear rockets and plasma rockets use hydrogen as reaction mass.

Enough fuel should be carried to allow the vessel to go the maximum 7.7 light year range for a stutterwarp vessel, plus at least a week's operation in the target system.

## INSTALL BRIDGE

The bridge and some associated systems are designed as per the *Traveller Core Rulebook*, page 107. Any modifications are noted here. For vessels over 2,000 tons, a standard bridge is 80 tons in size, and cost MLv0.8 per ton of ship.

**Communicators:** Use the communications systems and rules found in the *Traveller Core Rulebook*, page 108.

### **Cockpit or Control Cabin**

All small craft must have either a cockpit or a control cabin containing basic controls, communications equipment, avionics, scanners, detectors, sensors and other equipment for proper operation of the ship. A cockpit is much more cramped and uncomfortable but takes up less tonnage. No extra passengers can be carried in a cockpit; a control cabin allows for half as many passengers as crew to be carried. The cost for a cabin or cockpit is the same – MLv 0.1 per 20 tons of ship.

A cockpit takes up 1.5 tons per crewman; a cabin takes up 3 tons per crewman. The cockpit or control cabin includes a basic electronics suite. More advanced electronics suites can be installed (as per the rules for starship electronic suites).

## BRIDGE OPTIONS

**Command Bridge:** A command bridge is intended for use in warships that will be co-ordinating the efforts of a squadron of other spacecraft. It incorporates a large-scale holographic display of fleet actions, enhanced communications and control electronics and space for more command staff. A spacecraft command bridge takes up 40 tons but gives a +1 DM to Tactics (naval tactics) checks.

A command bridge costs 50% more than a conventional bridge for the same size of ship.

**Compact Bridge:** A compact bridge crams as much equipment and control stations into as small a place as possible. Compact bridges take up 25% less tonnage than a normal bridge of the same type but cost 10% more. However, all skill checks performed on the bridge suffer a -1 DM due to the un-ergonomic design.

**Hardened Bridge:** A hardened bridge is shielded against radiation attacks. The ship's computer systems are immune to EMP and the number of rads absorbed by the bridge crew is reduced by 1,000. Hardening a bridge adds 25% to the cost of the bridge. If a ship has radiation shielding installed, it is assumed to be hardened.

**Holographic Controls:** This bridge design incorporates advanced interactive holographic displays, reconfiguring itself to adapt to the current situation. A bridge with holographic controls is always optimised and gives a +2 bonus when rolling for Initiative. A holographic bridge adds 25% to the cost of the bridge.

## COMPUTER

The same basic rules from the *Traveller Core Rulebook* (page 108, 113) are used, with a few modifications.

**Computer Options:** Stutterwarp Control Specialisation (bis) (replaces Jump Control Specialisation).

**Computer Software:** Remove Jump Control from the list and add Stutterwarp Control. Note that computers and electronics in *2300AD* can go up to TL14 (New Military), although all other components are limited to TL12.

A good pilot can push a ship beyond the limits of the control program. Roll a Formidable Pilot Check, +Int. Speed increases by Effect x 0.5 light years/day, up to the maximum stutterwarp speed of the vessel.

| Program                 | TL | Rating | Cost | Effect   |
|-------------------------|----|--------|------|--|
| Stutterwarp Control / A | 9  | 5      | 0.1  | Allows stutterwarp travel at speeds of up to 1 light years a day.  |
| Stutterwarp Control / B | 10 | 10     | 0.2  | Allows stutterwarp travel at speeds of up to 3 light years a day.  |
| Stutterwarp Control / C | 11 | 15     | 0.40 | Allows stutterwarp travel at speeds of up to 5 light years a day.  |
| Stutterwarp Control / D | 12 | 20     | 0.80 | Allows stutterwarp travel at speeds of up to 7 light years a day.  |
| Stutterwarp Control / E | 13 | 25     | 1.2  | Allows stutterwarp travel at speeds of up to 9 light years a day.  |
| Stutterwarp Control / F | 14 | 30     | 1.4  | Allows stutterwarp travel at speeds of up to 11 light years a day. |

## ELECTRONICS AND SENSORS

Use the sensors as found in the *Traveller Core Rulebook*. NAS sensors are unavailable and densitometers are changed to deep-scan radars, same basic effect but a different technology.

Although *2300AD* has a maximum TL of 12, electronics can go up to TL14.

All civilian sensors as listed in the *Traveller Core Rulebook* have a starship combat range of 0 and are intended for navigational purposes only. Basic military sensors have a base range of 5 for starship combat, while Advanced Sensors have a base range of 7. Passive sensors are included as part of the sensor suite but the range on passive sensors is 3 less than the active range.

**Active vs. Passive:** Military sensor suites contain a full array of active and passive sensors. Active sensors are detectable at up to double their listed range, plus the range of the passive sensor doing the detecting. So an active sensor with a range of 3, would be detectable up to range 6 by any ship with a functioning sensor array and if a ship had an advanced sensor array, with a passive range of 4, then the active sensors could be detected at a range of 10.

## SENSOR OPTIONS

Upgraded sensor suites are common on larger vessels.

**Survey Sensors:** Survey sensors integrate a suite of probe drones and deployable satellites into the sensor system and are optimised for scanning large areas at great speed. Survey sensors are equivalent to Advanced Sensors but reduce the time taken to scan a planetary surface by one step. TL12, 10 tons, MLv10.

**Countermeasures Suite:** A countermeasures suite is specifically designed for jamming enemy transmissions. It is functionally equivalent to an advanced sensor suite but has a higher DM for countermeasures. The DM for these sensors is +4. TL11 7 tons MLv6.

**Military Countermeasures Suite:** The military countermeasures suite is the cutting edge of countermeasure technology in human space, incorporating both powerful transmitters and advanced electronic warfare programs to shut down enemy communications. TL 12, 20 tons, MLv15.

The DM for these sensors is +6.

## Sensor Upgrades

Any sensor suite may be upgraded with a range of options to improve the likelihood and quality of information and the range at which objects may be detected.

*Improved Signal Processing:* (TL 11, 1 ton, MLv 4) Signal processing consists of extremely specialised computers and software to improve the quality and likelihood of detection. Improved signal processing provides a +2 DM to sensor tasks and improves of range of 'full' and 'limited' by 2 for radar, lidar, densitometer, thermal and visual sensors. However, this comes at a cost of increased vulnerability to jamming, with all jamming DMs doubled.

*Enhanced Signal Processing:* (TL 12, 2 tons, MLv 8) As for Improved Signal processing except that it has a +4 DM, the range band increase is 4 and the susceptibility to jamming has been overcome.

*Distributed Arrays:* (TL 11, triples size and cost of sensor suite and associated signal processing) By using multiple hull-mounted arrays in an integrated computer-controlled arrangement, it is possible to increase the effective sensor antenna size and increase the longest range of the sensor (all increased range performance is at 'minimal' level of detail). This increases the range of an Advanced sensors from 7 to 10. This modification can not be added to standard sensors and can only be added to ships of 2,000 tons displacement or more.

*Extended Arrays:* As per the distributed array but as the arrays are extended well beyond the hull of the ship on retractable arms, there is no limit on the size of the ship. However, with the arms extended the ship can be detected at a +2 DM by all active sensors and it may not use its reaction drive.

*Grav Sensors:* (TL 11, 4 tons, MLv 4) A grav sensor can detect an operating stutterwarp drive at several light minutes and planets or asteroids at system-wide ranges, although without sufficient accuracy to get any information or provide a targeting solution. Targets of this nature are known as 'Black Globes' (no relation to the *Traveller* defensive technology of the same name).

## Bridge Crew Requirements

|                | Pilot | Sensors | Engineering | Communications | Navigation |
|----------------|-------|---------|-------------|----------------|------------|
| Non-Commercial | 2     | 1       | 1           | 1              | 2          |
| Commercial     | 3     | 2       | 2           | 2              | 3          |
| Military       | 3     | 3       | 3           | 3              | 3          |

These crew requirements fill all watches on the ship

# DETERMINING CREW SIZE

Crew sizes are determined by the following tables.

*Bridge Crew Requirements:* These are total numbers of crew, staffing all watches.

Non-commercial private vessels can get by with minimal crew. There should be sufficient crew for one full eight hour watch but the other two watches can be skeleton watches, with only two crew members per watch.

Commercial vessels have to have one full watch and two half-watches to staff the alternate watches.

Military vessels must have three full watches.

## Weapons Crew

*Gunners:* Non-military vessels require one gunner per TTA, UTES controller, screen or submunitions dispenser. Military vessels require two gunners per TTA, UTES controller, screen or submunitions dispenser.

*Missiles and Drones:* Ships require one crew per missile or drone director. Drones require an additional 'dog-watch' crew-member in case of alerts. Missile workshops require four crew members.

*Fighter Pilots:* One or two per fighter carried (depends on fighter), as well as fighter maintenance staff, which equate to three per fighter carried.

*Small craft pilots:* Small craft only require one crew member for every 50 tons or fraction thereof. So a 40 ton lander requires only a single crew member, while an 80 ton shuttle requires a crew of two. Commercial passenger-carrying craft must have a crew of at least two.

*Small Craft Maintenance:* Two per small craft carried.

*Facilities Crew:* All named facilities (briefing room, theatre, recreation area, swimming pool, workshop) require at least one crew member to be assigned to them

**Command Crew (optional):** Any commercial or military vessels over 1,000 tons can carry a command crew. On military vessels this is 10 people, while commercial vessels require six.

**Stewards:** Stewards are required at the rate of one for every 25 crew and one for every 10 passengers or command crew. This does not include the steward staff themselves.

**Engineering:** Engineering sections are staffed based on the type and output of the main Power Plant. This includes staff for the stutterwarp drive.

These values are for the total engineering crew and allow two rotating watches. In times of battle, half would be on duty in the engineering spaces, while the other half would form roving damage control parties. Military vessels should increase these engineering requirements by 50%, while non-commercial vessels may reduce them by 50%, rounding up.

## STATEROOMS AND LOW-BERTHS

Staterooms and other accommodation elements are designed as normal from the *Traveller Core Rulebook*, page 110. Low berths are more dangerous in 2300AD than in core *Traveller* and so are used sparingly.

Standard staterooms take up four tons, as per *Traveller* but only cost Lv100,000 each.

**Small Craft Couches:** A small craft may have acceleration couches for short duration passengers (such as for surface-to-orbit voyages). These take up 0.5 tons and cost MLv 0.03 each.

Deep hibernation, the 2300AD term for low berths, requires 12 hours to revive occupants, with a -1 DM to Medic skill checks per 10 years of age over 20 of the occupant. They are twice the cost of low berths from the *Traveller Core Book*.

### Engineering Crew Requirements.

| Drive Rating | MHD Turbine | Fuel Cell | Fusion Plant | Fission Plant |
|--------------|-------------|-----------|--------------|---------------|
| A            | 3           | 3         | —            | —             |
| B            | 3           | 3         | —            | —             |
| C            | 3           | 3         | —            | —             |
| D            | 3           | 3         | —            | —             |
| E            | 3           | 3         | —            | —             |
| F            | 3           | 3         | —            | —             |
| G            | 3           | 3         | —            | —             |
| H            | 3           | 3         | —            | —             |
| J            | 3           | 3         | —            | —             |
| K            | 3           | —         | —            | —             |
| L            | 3           | —         | —            | —             |
| M            | 3           | —         | —            | 4             |
| N            | 3           | —         | —            | 5             |
| P            | 4           | —         | —            | 6             |
| Q            | 4           | —         | —            | 13            |
| R            | 5           | —         | —            | 19            |
| S            | 5           | —         | —            | 25            |
| T            | —           | —         | —            | 30            |
| U            | —           | —         | 10           | 35            |
| V            | —           | —         | 11           | 40            |
| W            | —           | —         | 12           | 45            |
| X            | —           | —         | 13           | 50            |
| Y            | —           | —         | 16           | 63            |
| Z            | —           | —         | 18           | 75            |

## INTERNAL COMPONENTS

These are additional rooms and facilities for crews and passengers.

**Swimming Pools:** Some starships and stations contain swimming pools, one of the ultimate luxuries in a spacecraft. Pools can be contained in either the zero-gravity portion of the ship or in the gravity section. Both require equipment to contain and filter the water, which is included in the size and cost. Pools require 0.5 ton per occupant and cost Lv10,000 per ton.

**Recreation Facilities:** All shipboard quarters contain some provision for recreational facilities. These additional recreational facilities are required for long-duration missions, typically of journeys of more than a month. Recreation Facilities require 0.1 tons per occupant and cost Lv5,000 per ton.

**Theatres:** Theatres are used for large briefings, live performances, movies or immersives. The included costs and space requirements include the necessary equipment for all types of performances. Theatres require 0.75 tons per occupant and cost Lv20,000 per ton.

**Luxury Suites:** These represent high-class suites, complete with full bath facilities, separate sleeping rooms and living room. The tonnage required is not all just the suite but includes connecting corridors and other common spaces. Luxury suites require 8 tons and cost Lv500,000. Life support costs for luxury suites are 10x normal. A luxury stateroom can hold two occupants with no loss to Comfort and 4 at a comfort level of -1.

**Luxury Dining:** While minimal dining facilities are included in the space requirements and cost of all accommodations, luxury dining represents a true full-service restaurant. Luxury Dining requires 0.25 tons per person, cost Lv50,000 per ton and require an additional Steward per 12 people.

**Armoury:** Ships carrying a large number of marines or soldiers can benefit from an armoury, a specialised weapons store. An armoury can only be accessed by those with the correct codes (usually the ship's senior officers and security team) and contains a wide variety of weapons. In game terms, an armoury has enough pistols or submachineguns for the crew, enough rifles for any marines and a selection of other military equipment like grenades, combat drug packs, vacuum combat dress (VCD) and communications equipment. A general armoury for a spacecraft costs MLv 0.5 and takes up two 2 tons of space.

Where military vessels are concerned, the number of armouries built into the ship's design is based on crew size. One armoury is installed for either every 50 crew members or every 10 marines, in order to provide adequate storage for equipment, weapons and ammunition.

**Briefing Room:** A specialised briefing room is useful on mercenary cruisers and other adventuring ships, where teams can discuss plans or meet with clients privately. A briefing room gives

a +1 DM to Tactics (military tactics) checks made when planning missions on board ship. Ships with command bridges and fighter squadrons require additional briefing rooms and facilities. Military ships must have one briefing room for every 20 fighter or bomber crew. A briefing room takes up 4 tons and costs MLv 0.5.

**Hangar:** Normally, when a small craft is included in the design of a larger one, it is installed into a form-fitting enclosure in the hull of the mother vessel. The crawler on a landing craft, for example, is carried in a small compartment in the forward section, with barely enough room for passengers to scramble on board. Most repairs and maintenance require the crawler to be launched first.

Adding a full-scale hangar allows for repairs and maintenance of the small craft when they are back on the ship. The hangar includes spare parts and specialised testing and repair equipment for the stored craft.

A hangar requires 130% of the space allocated to the small craft and costs MLv 0.2/ton.

For example, carrying a landing craft normally takes up 50 tons of space. If it is given a full hangar, then it requires 65 tons of space instead.

**Laboratory:** Space allocated to laboratories can be used for research and experimentation. Each 4 tons of lab space allows for one scientist to perform research on board ship. The cost for research equipment varies depending on the type of research undertaken but is generally around MLv 1.0 per 4 tons.

**Library:** A library room contains computer files as well as lectures, display screens, holotanks and even hard copies of books. A good library is useful for both research and passing time on long journeys.

Having a library on board a ship gives one extra week of training time for new skills per week spent onboard. Libraries take up 4 tons of space and cost MLv4.

**Probe Drones:** Probe drones are small, reaction-drive units used for close range (<100 kilometres) inspection of ships and stations. They take up the same space and cost the same as the probe drones in *Traveller Core Rulebook*.

**Static Autodoc:** The static autodoc is detailed in the equipment chapter. It takes up 0.5 tons and costs Lv25,000.

**Vault:** A vault is a special armoured chamber in the heart of a spacecraft, designed to survive attacks that would annihilate the rest of the ship. A vault has another four Hull and Structure points that only come into play when the ship housing the vault is destroyed. A vault can contain cargo, staterooms or any other internal components equivalent up to 6 tons. The vault itself takes up 12 tons and costs MLv6.



**Workshop:** A workshop is a mechanical workshop designed to handle most repair work. It includes an industrial fabricator to manufacture new parts and other equipment as needed. The workshop takes up 8 tons and costs MLv4.

### Small Craft Components

**Airlock:** Unlike starships, a small craft does not have an airlock by default. Airlocks take up one ton each and cost MLv 0.2. If a craft does not have an airlock, then the crew cannot leave the craft except when it is landed or in a pressurised landing bay without opening the ship up to vacuum.

**Cabin Space:** Adding cabin space gives the crew more space to move around and to access other components of the ship, such as the engines or cargo bay. Every 1.5 tons of cabin space allows the craft to carry another passenger in moderate comfort (although passenger shuttles will customarily take Luxuries to upgrade the passenger section). Designating a section as cabin space costs MLv 0.05 per ton.

**Acceleration Couches:** A small craft may have acceleration couches for short duration passengers (such as for surface-to-orbit voyages). These take up 0.5 tons and cost MLv 0.03 each.

### Other Components

A small craft may have any of the components allowed to larger vessels.

## ARTIFICIAL GRAVITY

For any sort of long-duration flight, artificial gravity is necessary to maintain the health and well-being of the crew. The low gravities generated by spin habitats do contribute but still require stringent exercise and metabolic treatments. The psychological effects cannot be ignored; gravity allows the crew to eat, sleep and perform other daily functions in relative comfort and ease.

To design a spin habitat, add up the size of all ship components that you want to have under gravity.

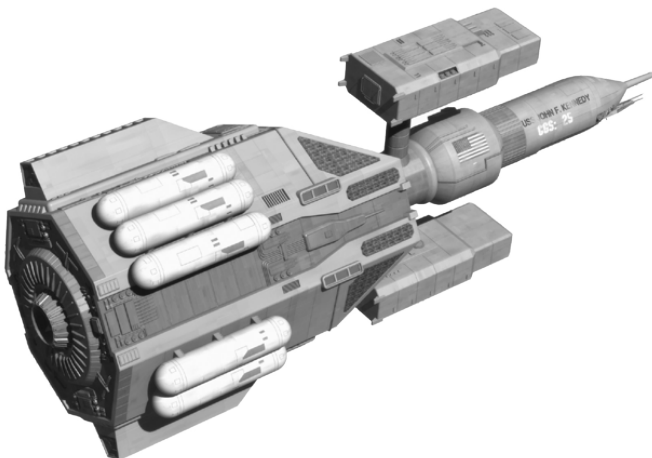

**Spun Hull:** This is the simplest but usually largest, spin habitat type available. The hull is simply a large cylinder that spins around its axis, providing gravity along the edge of the cylinder. Due to Coriolis effects, the central part of the cylinder (within a radius of 15 metres) is unusable for crew or passengers and is usually used for cargo, fuel and low maintenance machinery. About 20% of the hull would be maintained at a comfortable gravity, with the rest being largely unusable for humans.

Spun hulls have a minimum size of 500 tons.

**Double Hull:** The outer hull spins but surrounds an enclosed inner hull which does not. The design is most useful for large designs, as the enclosed central hull is at least 15 metres in radius. More often the hull is built as a torus and the central core is occupied by a non-spinning drive/power plant module. Most space stations are constructed in this fashion. Minimum size of the spun section is 60 tons.

**Hamster Cage:** The hamster cage is a cylindrical module that is at least 15 metres in radius and spins to create an artificial gravity. Unlike other designs, the hamster cage is usually set at right angles to the hull and is usually installed in counter-rotating pairs. This eliminates torque effects on the ship's attitude.

**Spin Capsules:** The spin capsule system is a set of small capsules at the end of a long rotating arm. Most ships have between one and four of these capsules, although two is the most common number.

**Extendable spin capsules:** The extendable spin capsule can retract against a vessel's hull, minimising the target profile and reducing the vulnerability of the ship's life support sections. This can also be used on a streamlined or air-frame vessel to fold the habitat areas away during atmospheric operations. This increases the size requirement by 50% and the price is doubled.

**Two-body:** Two ships of the same size can join up via a retractable tower or pylon and spin around the common centre of mass. The volume given is for the connecting tower.

### Spin Habitat Size and Cost

| Spin Habitat Type        | Size (Tons) | Price (MLv) |
|--------------------------|-------------|-------------|
| Spun Hull                | 0.0         | 0.01        |
| Double Hull              | 0.1         | 0.05        |
| Spin Capsules            | 0.2         | 0.05        |
| Extendable Spin Capsules | 0.4         | 0.10        |
| Hamster Cage             | 0.1         | 0.10        |
| Two-Body                 | 0.5         | 0.01        |

Size is for the spin machinery, including a flywheel, per ton of enclosed spin volume. For the two-body, the Size is for an extendable pylon and is 5% of the total size of the ships. The ships themselves must be of the same size.

Price is per ton of spin machinery.

Spin habitat size and cost is further modified by the spin radius. Use the following table to determine the size and cost multipliers, depending on spin hab size.

### Spin Habitat Radius Effects Table

| Spin Radius | Size Multiplier | Cost Multiplier | DM |
|-------------|-----------------|-----------------|----|
| 15          | X1              | X1              | +0 |
| 30          | X1.5            | X1.2            | +1 |
| 45          | X2              | X1.4            | +2 |
| 60          | X2.5            | X1.6            | +3 |

The DM is a modifier for opponents to both detect a vessel and a modifier on any To Hit roll.

### Spin Gravity Table

| Radius | 4 RPM | 3 RPM | 2 RPM | 1 RPM | <1 RPM |
|--------|-------|-------|-------|-------|--------|
| 15m    | 0.26g | 0.15g | 0.07g | 0.02g | 0.01g  |
| 30m    | 0.53g | 0.30g | 0.13g | 0.03g | 0.02g  |
| 45m    | 0.81  | 0.45g | 0.20g | 0.05g | 0.03g  |
| 60m    | 1.07  | 0.60g | 0.27g | 0.07g | 0.04g  |

Spin habitats must have a radius of at least 15 metres, in order to keep rotational effects to a minimum. Felt gravity inside a spin habitat is generally quite low. Gravity Dex/Str mods should be applied to characters travelling on a ship, whether under spin or not.

## ADDITIONAL DESIGN ELEMENTS

**Fuel Processors:** Note that fuel cells and MHD turbines use both hydrogen and oxygen, so only water and ice are suitable as a raw fuel source. The fuel processors break the water down into hydrogen and oxygen. Fuel processors require 20 (Plant TL) hours to refine 10 tons of fuel (not 200).

External components are mounted on the exterior of the hull of a spacecraft.

**Breaching Tube:** All airlocks include flexible plastic docking tubes that allow passengers to cross from one ship to another by floating through the air-filled tube. A breaching tube is a military version of the common docking tube. Instead of a thin myomer, the breaching tube is made of a combination of ballistic cloth and ceramic mesh. The breaching tube does not end in a docking collar but in a magnetic clamp with a ring of plasma torches that can burn through the hull of an enemy vessel when attached.

A breaching tube takes up three tons of space and costs MLV3. To use the breaching tube the craft must be adjacent to the tar-

get vessel and then succeed in a docking action (see *Traveller Core Rulebook*, page 147). As the vessel does not have to line up with an airlock, this manoeuvre is easier than using a normal docking tube and receives a +1 DM if the boarding vessel does not want to enter via the airlock.

If access is acquired via an airlock the plasma torches quickly burn through the airlock and boarding can begin immediately. If trying to get through the hull, the plasma torches will take one full turn to cut through, increasing by one turn for every two points of armour (round down).

Each breaching tube provides 10 armour against personal and vehicle weapons. A hit from a starship weapon will destroy the breaching tube if a successful Point Defence roll is made (see *Traveller Core Rulebook*, page 149).

**Docking Clamp:** A docking clamp allows a spacecraft to carry a small craft or other vessel on the outside of the hull. Recalculate the ship's Thrust and Stutterwarp Rating by adding the tonnage of the spacecraft and the docked craft together, round up to the nearest hull size, then compare that to the thrust by drive volume table. If performance is reduced to the point that it has no rating, then treat the ship as if it has the equivalent of a solar sail.

For example, a 200 ton vessel has a docking clamp. Attached to the clamp is a 50 ton cutter. Together, the vessels have a displacement tonnage of 250, which is rounded up to 300. The 200 ship has M-Drive B, which gives the combined spacecraft a Thrust of 1. When the cutter disconnects from the clamp, the 200 tonner will be back at its normal thrust of 2.

The size of the vessel that can be clamped depends on the size of the docking clamp.

### Docking Clamp Table

| Clamp Tonnage | Attached Ship Maximum | Cost (MLv) |
|---------------|-----------------------|------------|
| 1             | 10–40                 | 0.5        |
| 5             | 41–100                | 1.0        |
| 10            | 101–400               | 2.0        |
| 20            | 401–2,000             | 4.0        |
| 50            | 2,001+                | 8.0        |

**Grappling Arm:** A grappling arm is a remote control device for picking up or manipulating objects in space. The arm is five-segment mechanical arm that is capable of a wide degree of motion. It is capable of reaching out up to 25 metres, with a capacity of 2 tons. The arm ends in a set of cameras and grippers of varying sizes, from large claws to tiny micro-manipulators. It also carries a toolkit which can be customised for a particular task.

A grappling arm takes up two tons of space and costs MLV1.

# DETERMINE VESSEL COMFORT RATING

Comfort rating is used for a number of factors in *2300AD* starship operations. Higher Comfort ratings improve the odds of obtaining passengers, as well as improving overall crew performance.

The Comfort Rating is a direct DM, used in checks to get passengers and for all shipboard operations.

Vessels without artificial gravity can never have a comfort rating higher than 0, while ships with artificial gravity can have Comfort ratings up to +4. However and Comfort ratings above 2 do not affect ship performance, only the ability to attract passengers.

A ship with a limited number of luxury suites would have two Comfort ratings, one for the luxury guests, one for everyone else. In general, luxury suites and luxury dining do not tend to affect crew performance.

For items marked with a \*, only one may be counted towards crew comfort. However, all can be counted towards the Comfort Rating of the ship as it is used to attract and satisfy customers.

## DEFENCES

The design of defences is substantially changed from *Traveler*. Sandcasters, nuclear dampers, meson screens and Black Globes are all unavailable. Defences in *2300AD* are limited to point-defence, armour and screens.

### SCREENS

The military protective screen consists of thousands of reflective foil strips held in a dense protective sphere around the hull by an electromagnetic field generator. These strips serve to reflect and dissipate a significant fraction of the energy directed at them. The strips are not perfectly reflective, however and

absorbing even a small portion of the energy in a laser or particle beam strike is enough to destroy the reflectivity of the foil strip, which leads to it being vaporised milliseconds after being struck. It is thus possible to burn through a protective screen but this reduces the effectiveness of the weapon so used. Screens do not stack but redundant screens can be added.

Defensive screens marginally degrade the effectiveness of sensors. All Sensors skill rolls suffer a DM of -1 when screens are engaged, including spotting and targeting, when the screens are in use. At the same times, using screens makes the vessel more visible to opponents. Add a DM of +1 to opponent sensor rolls for active sensors only.

Screens subtract their rating from the damage caused by any attacks. This is before armour is taken into account. Each shot in a round degrades the screen's performance, reducing the rating by one. By the start of the next round, the screen is returned to full effectiveness by the release of redundant strips. The screen's operator can elect to not replenish the screen. A screen carries six reloads. After the reloads are exhausted, then the screen is degraded without being replenished. Additional reloads can be carried. It takes one Combat Round (five minutes) to reload a screen launcher.

*Power:* Screens use power to maintain the electromagnetic field that holds the foil strips in place. While using a screen, reduce stutterwarp speeds by 10% or forego firing energy weapons.

*Old Military Screens:* These screens are available at TL 11.

### Old Military Screens

| Rating | Size (Tons) | Price(MLv) |
|--------|-------------|------------|
| 1      | 1.5         | 4.5        |
| 2      | 2           | 9          |
| 3      | 3           | 15         |
| 4      | 4           | 21         |
| 5      | 5           | 27         |
| 6      | 6           | 33         |

### Starship Comfort Rating

|                              | No Gravity | Weak Gravity (0-0.2 G) | Low to Normal Gravity (0.2 -1.2G) |
|------------------------------|------------|------------------------|-----------------------------------|
| <b>Base Comfort</b>          |            |                        |                                   |
| Shared Stateroom             | -2         | -1                     | 0                                 |
| Single Stateroom             | -1         | 0                      | +1                                |
| Luxury Suite (1-2 occupants) | 0          | +1                     | +2                                |
| <b>Comfort Modifiers</b>     |            |                        |                                   |
| Luxury Dining                | -1*        | 0*                     | +1*                               |
| Pool                         | +1         | +1                     | +1                                |
| Recreation facilities        | +1         | +1                     | +1                                |
| Theatre                      | +1*        | +1*                    | +1*                               |
| Library                      | +1*        | +1*                    | +1*                               |

*New Military Screens:* These screens are available at TL 12.

### New Military Screens

| Rating | Size (Tons) | Price (MLv) |
|--------|-------------|-------------|
| 3      | 0.75        | 6           |
| 4      | 1.5         | 10.5        |
| 5      | 2           | 18          |
| 6      | 3           | 24          |
| 7      | 4           | 36          |
| 8      | 5           | 45          |

## WEAPON MOUNTS AND FIRE CONTROL

Weapons are not as common on civilian ships as in they are in *Traveller* and tend to be quite low-powered. None of the weapon types from the *Traveller Core Rulebook* are available in the *2300AD* setting. That means no meson guns, no spinal mounts or any of the other weapons. Instead, substitute for the weapons found in this section.

### Firing Aspects

There are six possible firing aspects for a ship, based on a hex. Aspect one is forward, Aspect four is aft. There is a degree of abstraction involved, so no weapon can fire into all aspects.

Firing Aspect is used to determine which weapons can target other vessels, based on whether the combat is head-on or a stern chase.

### HARDPOINTS

All ships have one hardpoint per 100 tons. Each hardpoint can mount a single weapon mount or standard gun tower. Fixed mounts and missile bays do not require hardpoints, gun towers require two hardpoints, while heavy gun towers require five hardpoints each.

### WEAPON MOUNTS

Weapon mounts are the turrets or fixed mounts that contain and protect a ship's weapon systems.

Weapons can be mounted onto turrets, barbettes and gun towers. Weapons can also be fired from missile bays, dropped by submunition dispensers and can be placed into fixed mounts.

*Submunition Dispensers:* Submunition dispensers do not require turrets but they take up half a hardpoint each, as they are in self-contained, non-traversing mounts.

*Fixed Mounts:* Fixed gun mounts are limited traverse mounts. They use 10% of the tonnage of the weapon mounted, plus the tonnage of the weapon. No cost. Fixed mounts only fire into one aspect, which must be set at time of construction

*Turrets:* Turrets are standard *Traveller Core Rulebook* turrets. They can mount up to two lasers or a Point Defence Cluster. One ton, MLv0.5 Turrets can fire into four aspects, which must be set at time of construction. Weapons mounted in turrets take up no additional space; they are subsumed in the tonnage of the turret itself.

*Pop-up Turrets:* Pop-up turrets are called jack turrets and weapons on a vessel intended for re-entry must have weapons in jack turrets, internal bays or fixed mounts. A jack turret can mount two lasers or a point defence cluster. Two tons, MLv1.5, Jack turrets can fire into three aspects, which must be set at time of construction.

*Barbettes:* Barbettes are large turrets. Railguns and particle cannons have to be mounted in barbettes, fixed mounts or gun towers. A barbette takes up a turret hardpoint and uses the Gunner (turrets) skill but also takes up space inside the ship, as the larger weapons mounted in a barbette need room for capacitors, targeting mechanisms, ammo feeds and other components. Barbettes can fire into four aspects, which must be set at time of construction.

*Gun Tower:* Gun towers extend the weapon away from the hull, allowing it to fire into a larger arc, although adding to the ship's signature. Any gun tower adds a +1 DM to active sensor detection rolls against it. Gun towers can mount up to two standard lasers or a single particle gun or rail guns. Gun towers use two hardpoints. Gun towers can fire into five aspects, which must be set at time of construction.

*Heavy Gun Towers:* Gun towers extend the weapon away from the hull, allowing it to fire into a larger arc, although adding to the ship's signature. Any heavy gun towers increase the active sensor detection DM to +2. Heavy gun towers can mount four standard lasers, two standard particle guns, two railguns, a heavy laser or a heavy particle gun. Heavy gun towers use five hardpoints. Heavy gun towers can fire into five aspects, which must be set at time of construction.

*Missile Bays:* Missile bays are designed as small craft bays and require 1.1 tons of space per ton of missile. Missile bays do not consume hardpoints, although ships are limited to one per every 100 tons. The size of a missile bay is equal to the number of missiles carried multiplied by the tonnage of the missiles multiplied by 1.1. Cost is equal to Lv10,000 per ton of bay. If maintenance is to be done on the missiles while the ship is in flight then the carrying vessel should have a workshop dedicated to the task. Missile workshops are 8 tons and cost MLv1.2. They include facilities for the safe handling of nuclear warheads.

## FIRE CONTROL

There are three types of fire control available for modern spacecraft.

**Target Tracking Array (TTA):** This is a centralised tracking and fire control system. One TTA is required per battery on the ship. All weapons in the battery must have the same facing aspect and be similar types of weapons (railguns, lasers or particle beam guns). TTAs are first available at TL9, take up 5 tons and cost Lv500.000.

**Unified Tracking and Engagement System (UTES, pronounced YU-tez):** This system puts a fire control director at each weapon, allowing the weapons to target independently. This is equivalent to the standard *Traveller* fire control. UTES takes 1 tons, costs Lv600,000 and is available at TL12. In the year 2300, the technology is only available to France, Britain, Germany (via Bavaria) and the United States.

**Missile Director:** This is a dedicated workstation and tightbeam communicator, used to control remote objects like drones and missiles. Each director can control only one object at a time.

### Fire Control

| Type                         | Size (Tons) | Cost (MLv) |
|------------------------------|-------------|------------|
| UTES                         | 1           | 0.6        |
| TTAs: 1 required per battery | 5           | 0.5        |
| Missile Director             | 0.25        | 0.5        |

## WEAPONS

Most nations in 2300AD forbid the ownership of starship weapons by civilians. It is possible for a civilian to get a license to carry starship weapons but the fees and inspections cost Lv50,000 per year. This license does not extend to bomb-pumped weapons like missiles and submunitions. These are always grossly illegal. Being caught with one of these weapons will result in a minimum jail time of 10 x the Law Level of the apprehending nation, in years.

### WEAPON TYPES

**Lasers (LL-98, LL-88, EA-122, EAS-1000):** Laser weapons are rapid-pulse types, designed to fire several bursts along the probability cone of a stutterwarping target. When used against a stationary target, double the damage.

**Heavy Lasers (Darlan LH220, Rostov Zh-78):** Although slower to fire and therefore less accurate, than lighter weapon systems, the heavy laser makes up for it with its greatly increased fire-power. It is possible to mount more than one of these weapons but, in practice, the power requirements are far too high for any but the very largest vessels. Heavy lasers may only be mounted in fixed mounts or heavy gun towers. A spacecraft mounting a heavy laser must have a Power Plant of 2 or

more rating higher than what the stutterwarp requires in order to fire this weapon, with a minimum rating of N.

**Rail Guns (DunArmCo ARG-56, Rostov K-19):** Railguns are huge gauss weapons, using a coil of electromagnets to accelerate a stream of ferrous projectiles to great speed. Railguns are of limited use in starship combat but do have some tactical advantages, as it is very difficult to counter a hail of metal slugs flying towards you at great speed. Railguns can only be used at Range 0.

**Particle Beam Weapons (BMZ-150, ALS-22, Quinn M-56):** Although not as fast to fire as lasers (and thus not as accurate) particle-beam weapons do inflict more damage, along with secondary radiation effects. Like the lasers, they are fired as a series of pulses against stutterwarping targets and so have their damage doubled when used against a stationary target. In addition to their damage, particle beam weapons also cause radiation exposure.

**Heavy Particle Beam Weapons (DunArmCo MP-1200, Allen BMZ-HPG-45):** Like their heavy laser counterparts, heavy particle beam weapons are less accurate than smaller weapons, although doing a great deal more damage. Heavy particle beam weapons may only be installed in fixed hull mounts or surface mounts. Although it is possible to mount more than one of these weapons, in practice the power requirements are far too high for any but the very largest vessels. Heavy particle beam weapons may only be mounted in fixed mounts or heavy gun towers. A spacecraft mounting a heavy particle beam weapon must have a Power Plant 3 or more letter ratings higher than what the stutterwarp requires in order to fire this weapon, with a minimum rating of M. In addition to their damage, heavy particle beam weapons also cause radiation damage.

**Point Defence Clusters (PDCs):** Although primarily used in a defensive role, point defence clusters can be used to fire on close-in targets and so are detailed in the weapons sections. A PDC is a set of rapid-firing, short-range laser weapons designed with a UTES targeting system and set to fire automatically. Anything within the range of the system is fired on automatically. The lower power of the system means that it is not very capable versus ships but against missiles it is very effective. The listed DM is the bonus of the defensive cluster versus missiles. PDCs are not typically installed in batteries but they can be. PDCs require a weapon mount, either a turret or jack turret and only one can be placed in either. However, they do not require separate targeting systems.

**Submunitions (LHH-637, Grape-Shot, Big-Clip LL-2):** Submunitions are classified as ordnance. They are small, nuclear-bomb-pumped, one-shot lasers. A starship drops the submunition and feeds it targeting information as the vessel moves away. When the dropping vessel is safely out of range, the submunition explodes, pumping a small detonation laser system.

**Missiles:** Missiles in 2300AD are all stutterwarp driven and come in several types: Bomb-pumped laser missiles, remote drones armed with a conventional laser or particle-beam system and bus missiles, which act as delivery vehicles for several smaller sub-munition-style warheads. Most missiles are remote-piloted vehicles and require a dedicated communicator on the controlling vessel. Bomb-pumped missiles are quite rare and it is extremely illegal for a civilian to have any. A civilian with one of these weapons usually means that someone needs to be tried for treason.

Missiles are launched from bays or carried externally in slings or missile packs.

**Vehicle Weapons:** Weapons from the Vehicle Design System can be added to starships and small craft. These weapons will be mounted either in jack turrets or surface mounts, while missiles can go in their own bays or on external hardpoints. Spaceships that are designed for re-entry should have the missiles in bays. Targeting computers should be included in the size of the weapon. For the purposes of holding vehicle missiles only, a spacecraft may have one hardpoint (capable of holding three missiles) for every 10 tons.

### Weapons

| Type                          | Nation        | TL | Tons | Cost | Dam | DMs | Range |
|-------------------------------|---------------|----|------|------|-----|-----|-------|
| <b>Lasers</b>                 |               |    |      |      |     |     |       |
| LL-98                         | France        | 9  | —    | 1    | 1d6 |     | 1     |
| LL-88                         | France        | 10 | —    | 1.5  | 1d6 | +1  | 1     |
| EA-122                        | United States | 11 | —    | 1.75 | 1d6 |     | 2     |
| EAA-1000                      | United States | 12 | —    | 2.0  | 2d6 |     | 2     |
| <b>Particle Beam Guns</b>     |               |    |      |      |     |     |       |
| BMZ-150                       | USA           | 10 | 2.0  | 3.0  | 3d6 | -2  | 1     |
| ALS-22                        | Australia     | 11 | 2.5  | 4.0  | 3d6 | -2  | 2     |
| <b>Point Defence Clusters</b> |               |    |      |      |     |     |       |
| Type 17 DC                    | Britain       | 12 | —    | 1.30 | 1d6 | +1  | 0     |
| Type 29 DC                    | Britain       | 12 | —    | 1.4  | 1d6 | +2  | 0     |

### Rail Guns

| Type   | Nation        | TL | Tons | Cost | Dam | DM S | Range |
|--------|---------------|----|------|------|-----|------|-------|
| ARG-56 | United States | 12 | 5    | 5    | 3d6 | -1   | 0     |
| K-19   | Germany       | 11 | 6    | 4    | 3d6 | -1   | 0     |

### Heavy Lasers

| Weapon       | Nation | Tons | MLv | Damage | TL | DM | Range |
|--------------|--------|------|-----|--------|----|----|-------|
| Darlan LH220 | France | 20   | 35  | 5d6    | 12 | -1 | 3     |
| Rostov Zh-78 | Russia | 25   | 40  | 5d6    | 11 | -1 | 2     |

### Heavy Particle Beam Guns

| Weapon           | Nation        | Tons | MLv | Damage | TL | DM | Range |
|------------------|---------------|------|-----|--------|----|----|-------|
| DunArmCo MP-1200 | Australia     | 32   | 55  | 7d6    | 12 | -2 | 2     |
| Allen BMZ-HPG-45 | United States | 34   | 45  | 6d6    | 12 | -3 | 2     |

## SUBMUNITION DISPENSER

The submunition dispenser is a rack for launching the submunitions. It has no integral fire support. A UTES can be added to a dispenser for the normal cost or it can make use of a TTA. Submunitions have no facing and can fire into any aspect. Submunition dispensers can be combined into batteries, controlled by a TTA, though this is rare. All submunitions have a range of 1.

Size is the dispenser size in tons, Cost is per dispenser. Shots is the number of submunitions contained in the dispenser. Rof is the number of submunitions that a dispenser can launch per Combat Round.

All Missiles have Hull and Structure of 0, meaning they can be destroyed by a single shot.

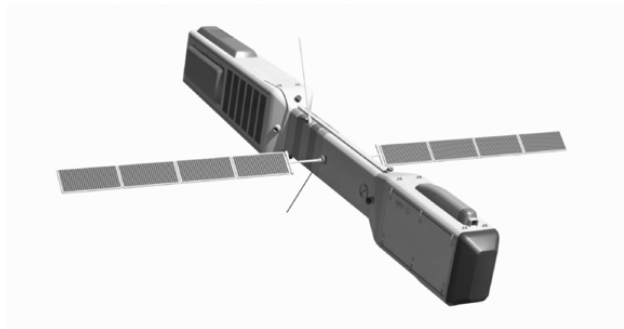

### Submunition Dispensers

| Type       | Nation  | TL | Size (Tons) | Cost (MLv) | Damage  | Shots | ROF | Cost /shot | Shot Size | Warhead Yield |
|------------|---------|----|-------------|------------|---------|-------|-----|------------|-----------|---------------|
| LHH-637    | Germany | 11 | 2           | 1          | 1d6x1d6 | 4     | 3   | 0.25       | 0.20      | 120 kt        |
| LL-2       | France  | 11 | 3           | 1.5        | 1d6x2d6 | 5     | 3   | 0.20       | 0.25      | 180 kt        |
| Grape-Shot | America | 12 | 6           | 2.5        | 4d6     | 24    | 10  | 0.15       | 0.15      | 240 kt        |
| Big Clip   | America | 12 | 2           | .75        | 2d6x2d6 | 3     | 3   | 0.25       | 0.25      | 240 kt        |

### Missile Table

| Missile  | Nation    | TL | Warhead          | Shots | Damage  | Size (Tons) | Tactical Speed | Warhead Yield |
|----------|-----------|----|------------------|-------|---------|-------------|----------------|---------------|
| Ritage-1 | France    | 11 | Battery Laser    | 5     | 1d6     | 4.00        | 7              | N/A           |
| Ritage-2 | France    | 12 | Detonation Laser | 1     | 1d6x1d6 | 1.00        | 8              | 120 kt        |
| EM-1     | Argentina | 10 | Battery Laser    | 20    | 1d6     | 2.00        | 4              | N/A           |
| EM-5D    | Argentina | 11 | Detonation Laser | 1     | 1d6x2d6 | 0.50        | 6              | 180kt         |
| AAS-2    | Brazil    | 11 | Battery Laser    | 20    | 1d6     | 5.00        | 3              | N/A           |
| AAS-4    | Brazil    | 12 | Detonation Laser | 1     | 1d6x1d6 | 1.00        | 4              | 120 kt        |
| SR-9     | Germany   | 11 | Detonation Laser | 1     | 1d6x1d6 | 3.00        | 6              | 120 kt        |
| SR-10    | Germany   | 12 | Detonation Laser | 1     | 1d6x3d6 | 5.00        | 7              | 240 kt        |
| Fantan   | Manchuria | 11 | Detonation Laser | 1     | 1d6x2d6 | 1.00        | 7              | 120 kt        |
| Glowworm | Manchuria | 10 | Battery Laser    | 4     | 1d6x1d6 | 5.00        | 6              | N/A           |
| SIM-14   | America   | 12 | Detonation Laser | 1     | 1d6x3d6 | 2.00        | 7              | 240 kt        |
| Silka    | Ukraine   | 11 | Detonation Laser | 1     | 1d6x2d6 | 0.50        | 6              | 180 kt        |

Warhead type denotes weapon type. Shots is number of time it can fire, for detonation lasers, this is obviously only 1. Damage is the number of shots multiplied by the dice of damage from each shot.

### Missile Packs

Missile packs are externally-mounted boxes of missiles that contain between one and four missiles and a missile controller. They can be connected to any bridge or gunnery workstation to allow control of the missile. Missile packs can be disposable but they are usually retained and reloaded.

Missile Pack cells is the number of missiles carried in a standard pack for that missile type.

Missile pack size is the tonnage of the missile pack.

Missile pack cost is without missiles.

Controllers: Some missile packs have more than one controller.

### Drones

Drones require small craft fittings, whether internal hangers or external slings.

### SENSOR DRONES

*American HD-10 'Scout' Sensor Drone:* The HD-10 is the current American sensor drone and is designed to be as cheap and disposable as possible.

*French Voir Sensor Drone:* The Voir Sensor drone is one of the fastest vessels ever created by man. The Voir is designed to pass through a military formation too fast for any weapons to get a bead on it, as it is quite fragile.



| Missile Type | Nation    | Missile Pack Cells | Missile Pack Size (Tons) | Missile Pack Cost (MLv) | Controllers |
|--------------|-----------|--------------------|--------------------------|-------------------------|-------------|
| Ritage-1     | France    | 4                  | 18                       | 3                       | 2           |
| Ritage-2     | France    | 3                  | 6                        | 2.5                     | 1           |
| EM-1         | Argentina | 2                  | 6                        | 2.0                     | 1           |
| EM-5D        | Argentina | 2                  | 3                        | 2.0                     | 1           |
| AAS-2        | Brazil    | 3                  | 17                       | 2.5                     | 1           |
| AAS-4        | Brazil    | 4                  | 6                        | 4                       | 2           |
| SR-9         | Germany   | 4                  | 14                       | 3.0                     | 1           |
| SR-10        | Germany   | 3                  | 17                       | 2.5                     | 1           |
| Fan Tan      | Manchuria | 6                  | 8                        | 4                       | 1           |
| Glowworm     | Manchuria | 4                  | 22                       | 3                       | 1           |
| SIM-14       | America   | 4                  | 12                       | 4.0                     | 2           |
| Silka        | Ukraine   | 4                  | 4                        | 3.0                     | 1           |

### Drone Table

| Drone Type    | Nation  | TL | Classification | Tactical Speed | Hull/Structure | Size (Tons) | Cost (MLv) |
|---------------|---------|----|----------------|----------------|----------------|-------------|------------|
| HD-10 'Scout' | America | 11 | Recon          | 8              | 0/1            | 11          | 4          |
| Voir          | France  | 12 | Recon          | 11             | 0/1            | 13          | 8.4        |
| D-23          | Germany | 10 | Decoy          | 8              | 0/1            | 10          | 4.8        |
| Goalkeeper    | Britain | 12 | Point Defence  | 7              | 0/0            | 5           | 4.4        |



**OTHER DRONES**

*D-23 Decoy Drone:* The D-23 is a commercially-available decoy drone designed to simulate ships up to 1,000 tons in displacement or down to 100 tons. These are quite popular with merchant vessels moving through hostile territory.

Appears to be the vessel it is emulating to sensors. Requires a Formidable Sensors check to determine the difference.

*Goalkeeper Point Defence Drone:* The Goalkeeper is a new design, only out in quantity since 2295. Developed by British Exospace in response to a tender from the Royal Navy, the Goalkeeper drone is designed to intercept missiles at a safe distance from the controlling vessel and destroy them with its point-defence cluster. Mounts a DC-17 Point Defence Cluster.

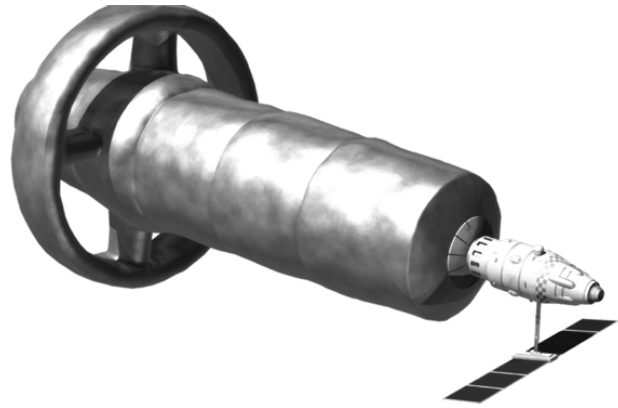

**DESIGN EVALUATION**

| Hull                | <subcategory> |              | Size | Cost |
|---------------------|---------------|--------------|------|------|
|                     |               |              |      |      |
| Armour              |               |              |      |      |
| Stutterwarp Drive   | Unloaded      |              |      |      |
|                     | Loaded        |              |      |      |
|                     | Tactical      |              |      |      |
| Reaction Drive      |               |              |      |      |
| Power Plant         |               |              |      |      |
| Radiators           |               |              |      |      |
| Bridge              |               |              |      |      |
| Computer            |               |              |      |      |
| Electronics/Sensors |               |              |      |      |
|                     |               |              |      |      |
| Weapons             | Mount 1       |              |      |      |
|                     | Mount 2       |              |      |      |
| Screens             |               |              |      |      |
|                     |               |              |      |      |
| Fuel                |               |              |      |      |
| Cargo               |               |              |      |      |
| Staterooms          |               |              |      |      |
| Other Fixtures      |               |              |      |      |
| Spin Habitat        |               | Detection DM |      |      |
|                     |               |              |      |      |
|                     |               |              |      |      |
|                     |               |              |      |      |
|                     |               |              |      |      |
|                     |               |              |      |      |
| Maintenance Cost    |               |              |      |      |
| Life Support Cost   |               |              |      |      |
| Total Cost          |               |              |      |      |

## **WEAPONS ON SMALL CRAFT**

The number of weapons allowable depends on the size of craft. Weapons are divided into two categories – ship weapons and vehicle weapons. Vehicle weapons are too short-ranged and low-powered to be of use against spacecraft.

One TTA or UTES mount must be installed for each turret or fixed mount (see page 111 of the *Traveller Core Rulebook*). Anti-personnel weapons do not need to be placed in turrets – instead, they are mounted on the external surface of the craft.

### **Small Craft Weapons**

| <b>Small Craft Size</b> | <b>Ship Weapons</b> | <b>Vehicle Weapons</b> |
|-------------------------|---------------------|------------------------|
| 10                      | 1                   | 1                      |
| 20                      | 1                   | 2                      |
| 30                      | 1                   | 3                      |
| 40                      | 2                   | 4                      |
| 50                      | 2                   | 5                      |
| 60                      | 2                   | 6                      |
| 70                      | 3                   | 7                      |
| 80                      | 3                   | 8                      |
| 90                      | 4                   | 9                      |

Ship weapon types available for small craft are limited. Rapid-fire mounts may not be fitted. Barbette Particle beams can be fitted but use the equivalent of two ship weapons (and a turret). Missile and submunition dispensers can be carried, with each using a ship's weapon slot. A missile pack also only uses one slot, although it may contain up to four missiles. A missile bay uses two slots but it can carry as many missiles as space allows.

### **Vehicle Weapons**

Vehicle weapons must be mounted in remote turrets or bays. These are not the same as starship turrets and bays. Turrets cost 10% of the price of the weapon and the weapons and turret together take up volume at the rate of 20 spaces/ton. Missile bays take up a similar amount of room. For small craft that must undergo re-entry, these are jack turrets, at double the cost.

## **CARGO**

Any left-over space can be designated as cargo.

# STARSHIPS, SPACECRAFT AND SPACESTATIONS

Starships and their support structures, including interface vessels and space stations, are the lifeblood of Human economy and a literal lifeline for most colonies, which could not exist without continued interstellar travel. This chapter describes and details many of the ships in operation in Human space but there are many more.

## INTERFACE VESSELS

The designation of Interface Vessel covers everything from disposable rockets to combat landers, as long as they are designed to take-off from or land on, a planet. SSTOs are often seen throughout the Frontier and conventional rockets are still widely used as a cheap method of interface travel.

## STAR CARRIER XV CARGO ROCKET

The Star Carrier is a single-stage Manchurian design that is found throughout the Frontier. Cheap, reliable and disposable, the Star Carrier is useful for putting large cargos into orbit.

TL: 10

First Example Laid Down: 2212

Last Example Laid Down: In production

Number Produced: Unknown

Producing Nation: All



| Hull                   | Star Carrier XV      |                  | Size (tons) | Cost |
|------------------------|----------------------|------------------|-------------|------|
| 50 ton hull            | Hull                 | 1                |             | 0.75 |
|                        | Structure            | 1                |             |      |
| Streamlining           | Standard             | Disposable       |             |      |
| Landing Roll           | N/A                  |                  |             |      |
| Take-off Roll          | N/A                  |                  |             |      |
| Armour                 | 0                    |                  |             |      |
| Heat Shielding         | None                 |                  |             |      |
| Stutterwarp Drive      | Unloaded             | 0                |             |      |
|                        | Loaded               | 0                |             |      |
|                        | Tactical             | 0                |             |      |
| Reaction Drive         | Liquid-fuel Rocket A | 3 G Acceleration | 4           | 9    |
| Power Plant            | N/A                  |                  |             |      |
| Radiators              | N/A                  |                  |             |      |
| Cockpit                | Remote-Operated      |                  | 1.5         | 0.25 |
| Computer               | Model 1              |                  |             | 0.03 |
| Electronics/Sensors    | Basic Civilian       |                  | 1           |      |
| Fuel                   | 3 hours              |                  | 22.5        |      |
| Cargo                  |                      |                  | 21          |      |
| Passenger Couches      |                      |                  |             |      |
| Maintenance Cost       |                      |                  |             | N/A  |
| Life Support Cost      |                      |                  |             | N/A  |
| Total Tonnage and Cost | Disposable (50%)     |                  | 50          | 5.03 |

# Star Carrier XV Cargo Rocket

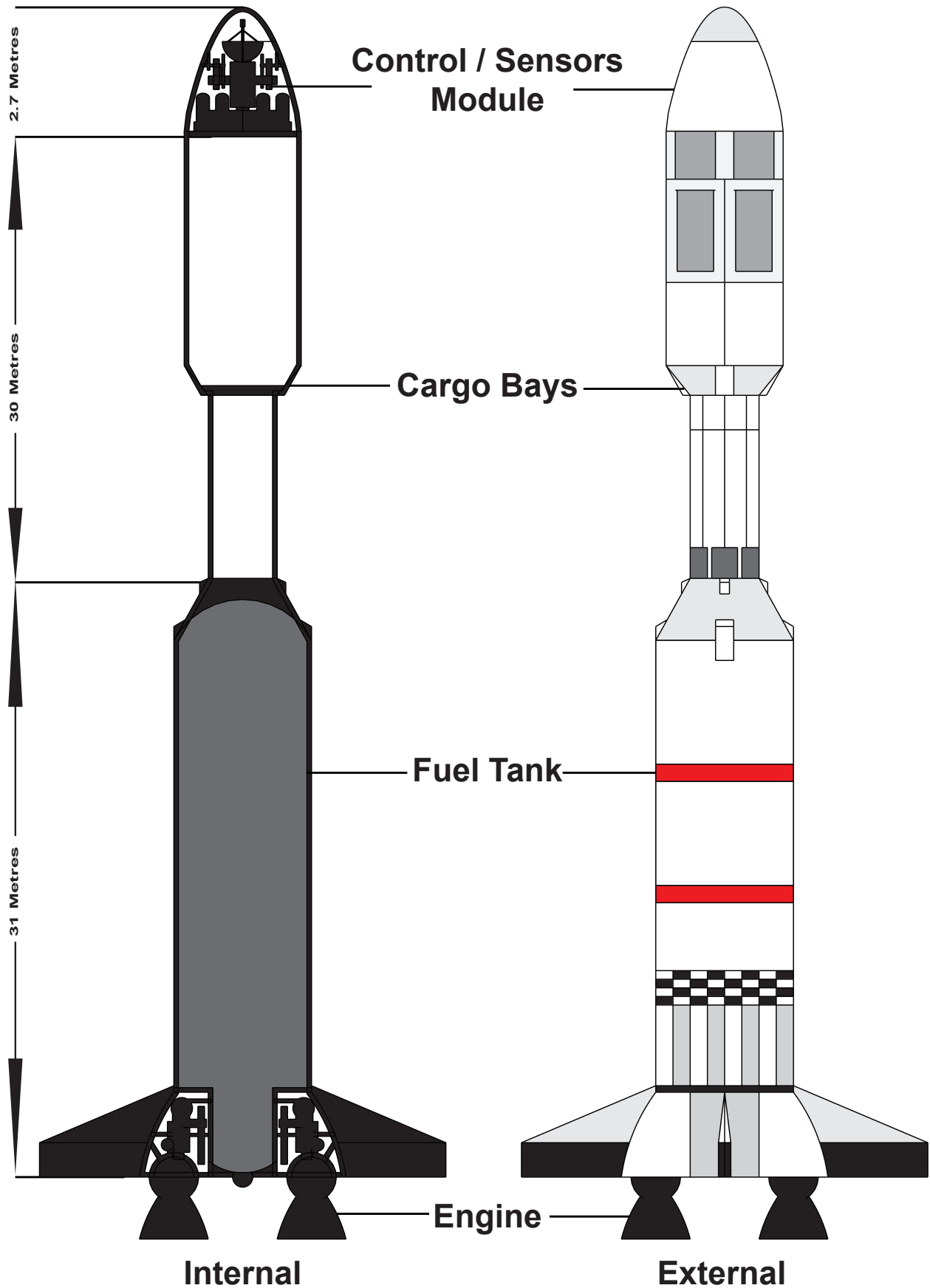

## AB.400 PASSENGER SPACEPLANE

The AB.400 is typical of the mid-sized scramjet spaceplanes used for commercial interface transport all over human space. Though designed primarily to carry passengers, the AB.400 can also carry a considerable amount of cargo in the bay under the passenger section.

TL: 11

First Example Laid Down: 2267

Last Example Laid Down: 2298

Number Produced: 1200

Producing Nation: France

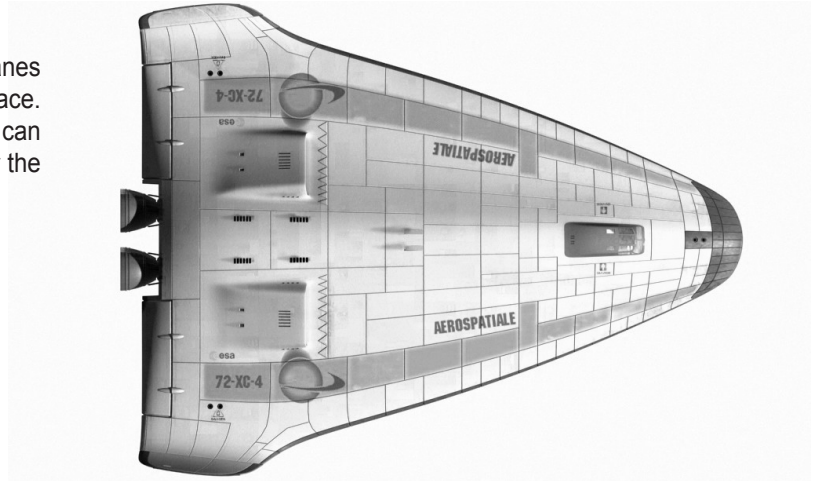

### AB.400 Passenger Spaceplane

| Hull                   | Passenger Spaceplane |                  | Size (tons) | Cost       |
|------------------------|----------------------|------------------|-------------|------------|
| 80 ton hull            | Hull                 | 1                |             | 0.9        |
|                        | Structure            | 1                |             |            |
| Streamlining           | Hybrid Lifting Body  |                  | 0.8         | 0.8        |
| Landing Roll           | 800m                 |                  |             |            |
| Take-off Roll          | 960m                 |                  |             |            |
| Armour                 | 0                    |                  |             |            |
| Heat Shielding         |                      |                  |             | 0.8        |
| Stutterwarp Drive      | Unloaded             | 0                |             |            |
|                        | Loaded               | 0                |             |            |
|                        | Tactical             | 0                |             |            |
| Reaction Drive         | Air-Breathing Rocket | 2 G Acceleration | 3.6         | 7.2        |
| Power Plant            | N/A                  |                  |             |            |
| Radiators              | N/A                  |                  |             |            |
| Cockpit                | 2 Crew               |                  | 3           | 0.8        |
| Computer               |                      |                  |             |            |
| Electronics/Sensors    |                      |                  |             |            |
| Fuel                   | 5 hours              |                  | 16          |            |
| Cargo                  |                      |                  | 11.4        |            |
| Passenger Couches      | 90                   |                  | 45          | 2.7        |
| Maintenance Cost       |                      |                  |             | 0.01/month |
| Life Support Cost      |                      |                  |             |            |
| Total Tonnage and Cost |                      |                  | 80          | MLv13.2    |

# AB 400 Passenger Spaceplane

Flight Deck

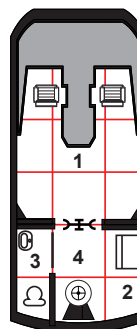

1. Cockpit
2. Emergency Locker
3. Head
4. Main Deck Access

Flight Deck is 1.5m High

Fuel Tanks  
(less than 1m thick)

Main Deck

1. 1st Class
2. Head
3. Galley/Storage
4. Entrance/Exit
5. Upper Deck Access
6. Standard Class
7. Emergency Exit
8. Engine Maintenance Access
9. Life Support
10. Air Intakes

Main Deck is 3m High

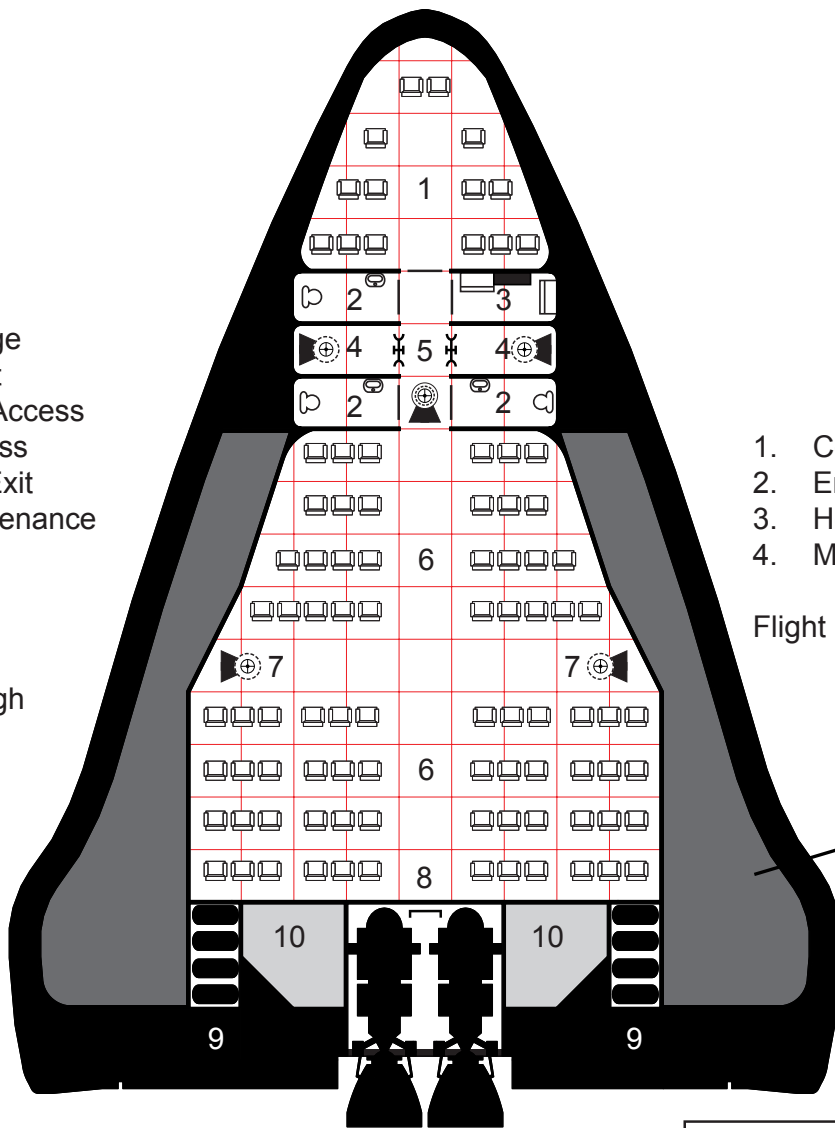

Air Breathing  
Rocket Drive

Cargo Deck

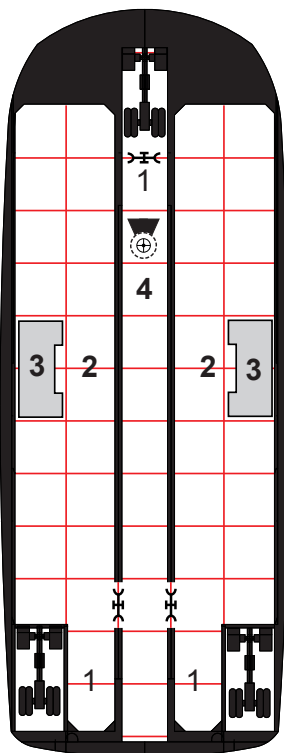

1. Landing Gear
2. Cargo Bay
3. Bay Doors
4. Upper Deck Access

Cargo Deck is 1.5m High

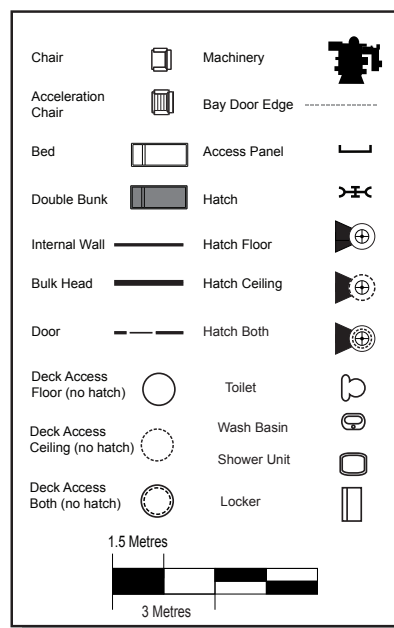

## OVL-22 UTILITY SSTO

The SSTO is one of the more flexible interface vehicles available and inexpensive to produce, owing to the 'conventional' rocket it uses. The design of the SSTO allows it to take-off and land vertically on its six great rotors and it will not cause a conflagration upon landing, unlike more conventional designs. It carries a substantial amount of cargo but lacks the atmospheric loiter time of a lander with air-breathing thrusters.

TL: 11

First Example Laid Down: 2301

Last Example Laid Down: In production

Number Produced: 590

Producing Nation: America

### OVL-22 Utility SSTO

| Hull                   |                         |                  | Size (tons) | Cost (MLv)  |
|------------------------|-------------------------|------------------|-------------|-------------|
| 40 ton hull            | Hull                    | 1                |             | 0.7         |
|                        | Structure               | 1                |             |             |
| Streamlining           | Standard (Non-airframe) |                  |             |             |
| Landing Roll           | N/A                     |                  |             |             |
| Take-off Roll          | N/A                     |                  |             |             |
| Armour                 | 0                       |                  |             |             |
| Heat Shielding         | N/A                     |                  |             | 4           |
| Stutterwarp Drive      | Unloaded                | 0                |             |             |
|                        | Loaded                  | 0                |             |             |
|                        | Tactical                | 0                |             |             |
| Reaction Drive         | SSTO Rocket sG          | 3 G Acceleration | 7.0         | 8           |
| Power Plant            | N/A                     |                  |             |             |
| Radiators              | N/A                     |                  |             |             |
| Cockpit                | 2 Crew                  |                  | 3           | 0.25        |
| Computer               | Computer/1              | Rating 5         |             | 0.16        |
| Software               | Maneuver/1              |                  |             |             |
| Electronics/Sensors    | Basic Civilian          |                  |             |             |
| Fuel                   | 3 hours                 |                  | 14.4        |             |
| Cargo                  |                         |                  | 14.61       |             |
| Passenger Couches      | 2                       |                  | 1           | 0.2         |
| Maintenance Cost       |                         |                  |             | 0.001/month |
| Life Support Cost      |                         |                  |             |             |
| Total Tonnage and Cost |                         |                  | 40          | MLv13.31    |

# OVL-22 Utility SSTO

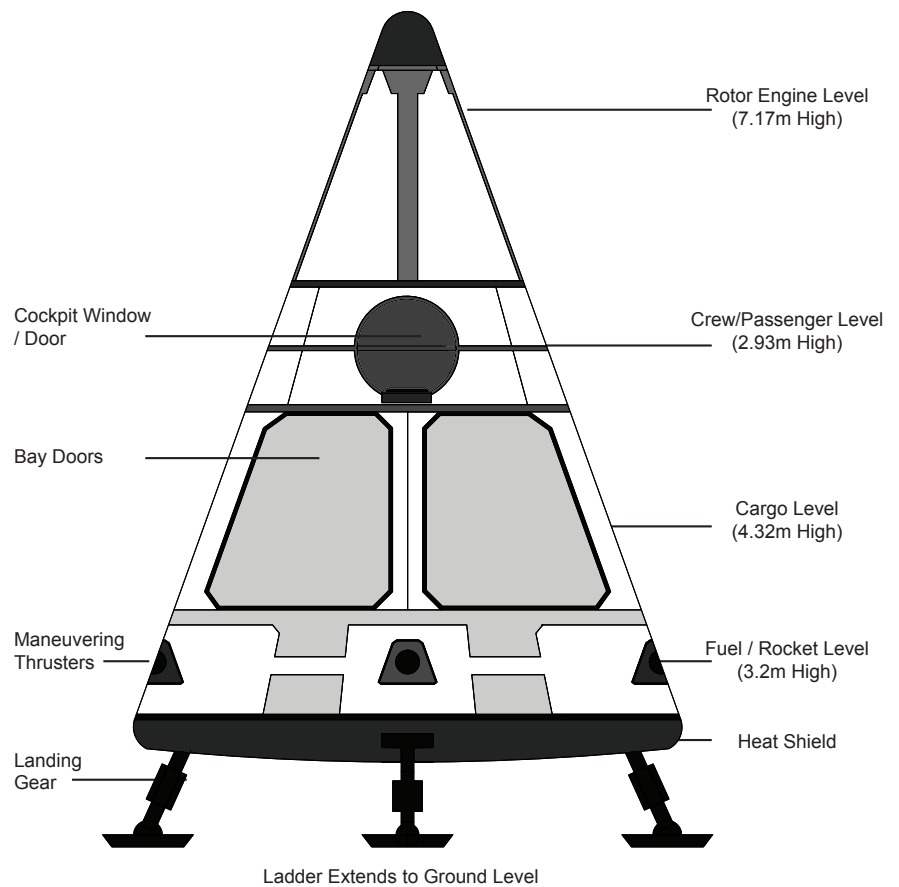
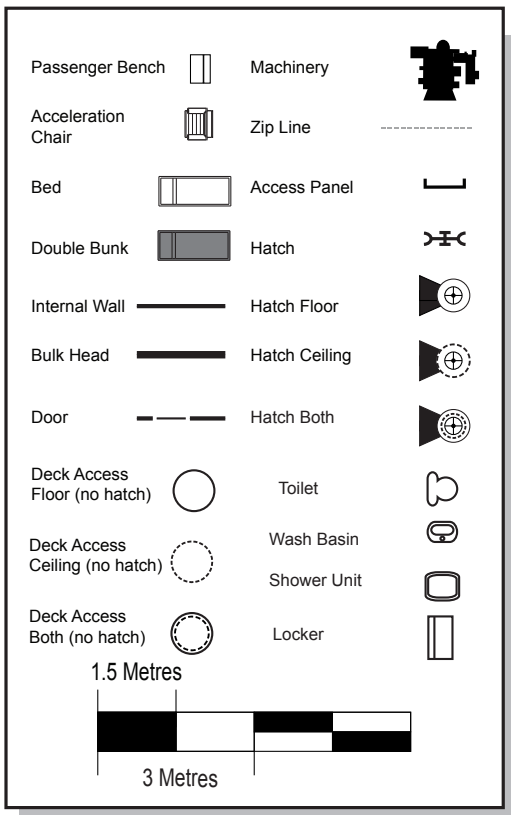
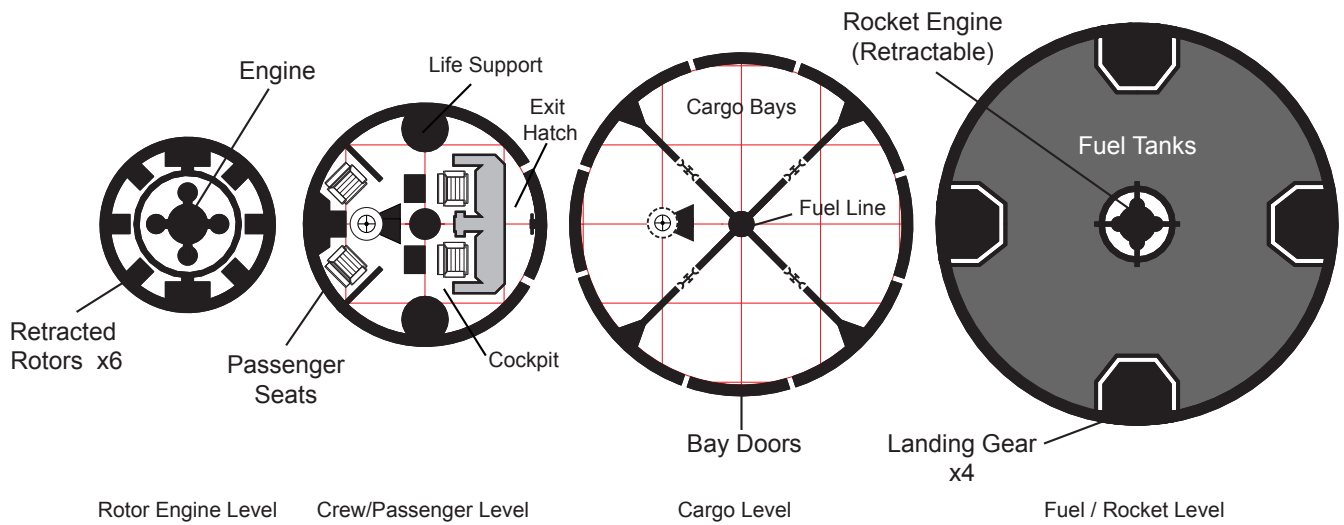



### CIT-III A COMBAT LANDER

The American CIT-III A Combat lander carries a mechanised squad and their vehicle down from orbit to a planetary landing. Powered by an air-breathing rocket, the CIT-III A has significant atmospheric manoeuvrability.

Combat landers are officially considered too valuable for use in ground support and are only armed for self-defence. To meet the demands of the modern battlefield, however, they are often pressed into service as ground support craft. The CIT-III A is a VTOL craft capable of sustained atmospheric flight.

The 20 missiles are carried in two internal bays on rotary launchers, while the 30mm cannon is protected in a retractable jack turret. The jack turret and missile bays must remain closed for re-entry manoeuvres and for hypersonic flight.

TL: 12  
 First Example Laid Down: 2298  
 Last Example Laid Down: In Production  
 Number Produced: 32  
 Producing Nation: America

#### CIT-III A Combat Lander

| Hull                   |                        |                            | Size (tons) | Cost (MLv) |
|------------------------|------------------------|----------------------------|-------------|------------|
| 70 ton hull            | Hull                   | 1                          |             | 0.85       |
|                        | Structure              | 1                          |             |            |
|                        | Stealth                |                            |             | 4          |
|                        | Radiation Shielding    |                            |             | 4          |
| Streamlining           | Lifting Body           |                            | 1.4         | 1.4        |
|                        | VTOL                   |                            | 7           | 0.75       |
| Landing Roll           | 800m                   |                            |             |            |
| Take-off Roll          | 960m                   |                            |             |            |
| Armour                 | 9                      | Composite                  |             | 1.69       |
| Heat Shielding         |                        |                            |             | 0.8        |
| Stutterwarp Drive      | Unloaded               | 0                          |             |            |
|                        | Loaded                 | 0                          |             |            |
|                        | Tactical               | 0                          |             |            |
| Reaction Drive         | Air-Breathing Rocket C | 3.0 G Acceleration         | 4.0         | 8.8        |
| Power Plant            | N/A                    |                            |             |            |
| Radiators              | N/A                    |                            |             |            |
| Cockpit                | 2 Crew                 |                            | 3           | 0.25       |
| Computer               |                        | Model/1                    |             | 0.03       |
| Electronics/Sensors    | Basic Military         |                            | 2           | 0.1        |
| Fuel                   | 8 hours                |                            | 33.6        |            |
| Cargo                  |                        |                            |             |            |
| Passenger Couches      | 12                     |                            | 6           | 0.3        |
| Other Fixtures         | Vehicle Bay            |                            | 12          |            |
| Weapon Mount 1         | Jack turret            | 20mm gatling w/1000 rounds | 0.5         | 0.2        |
| Weapon Mount 2         | Missile Bay            | 20 Aero-12 Missiles        | 0.5         | 0.1        |
| Maintenance Cost       |                        |                            |             | 0.01/month |
| Life Support Cost      |                        |                            |             |            |
| Total Tonnage and Cost |                        |                            | 70          | MLv23.27   |

# CIT-III Combat Lander

## Lower Deck

1. Sensors/Avionics Bay
2. Storage Locker
3. Life Support
4. Upper Deck Access
5. Exit

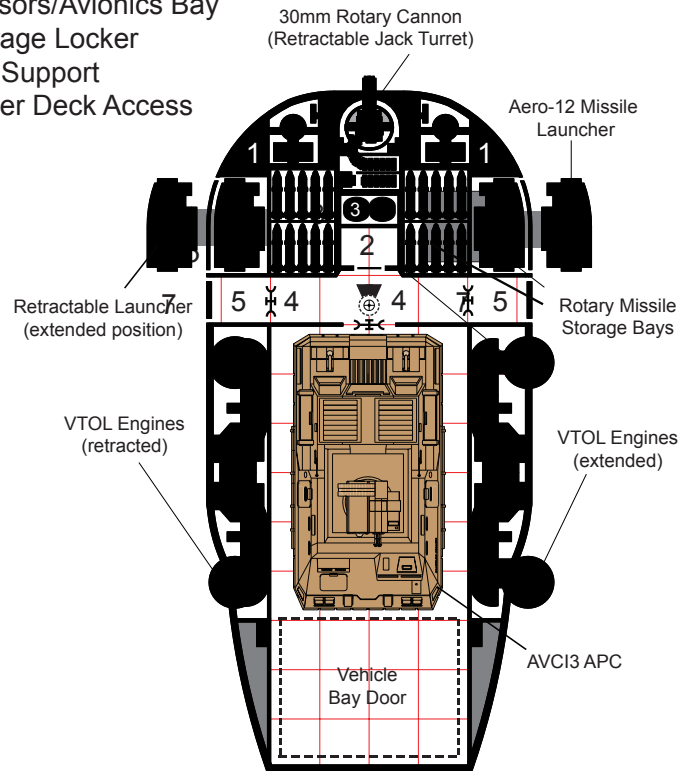

## Upper Deck

1. Cockpit
2. Pilot Position
3. Tactical Officer Position
4. Lower Deck Access
5. Passenger Bay
6. Emergency Engine Crawl Space
7. Air In-takes

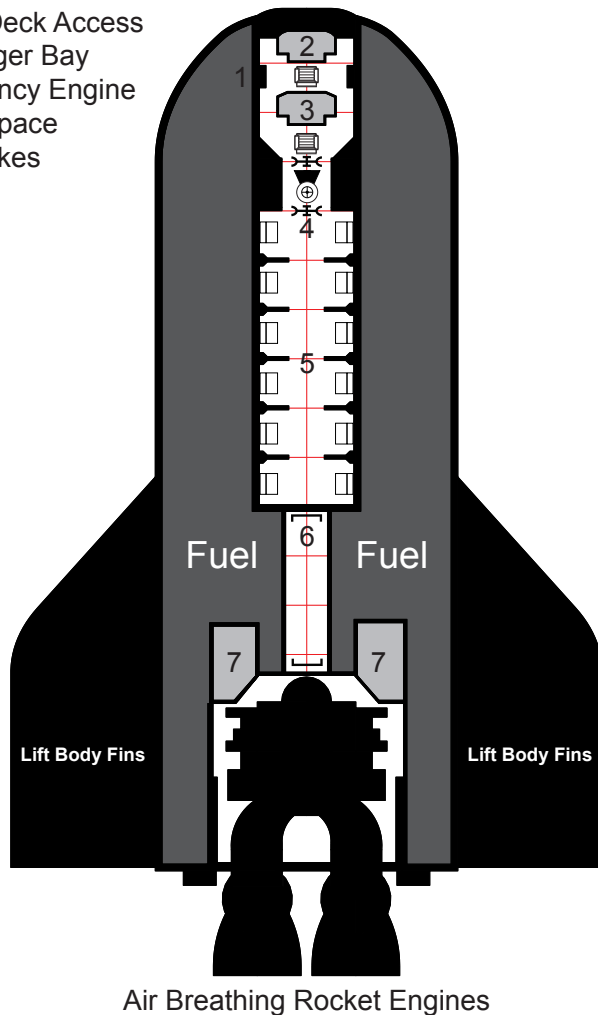

Both decks between 3m high to 1.5m in some sections

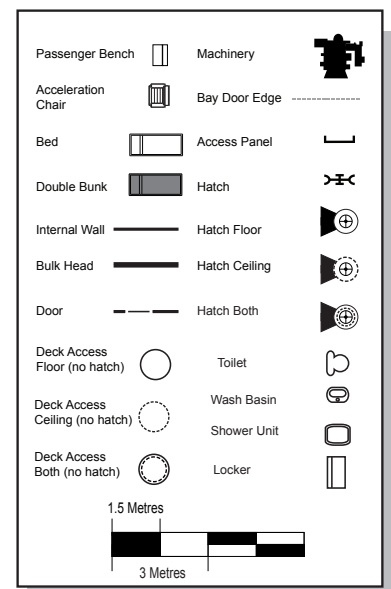

## BEANSTALK PASSENGER CAPSULE

Built on a custom 100-ton hull, the beanstalk capsule is designed to carry up to 20 passengers in great comfort to or from a world's surface. Despite being the most comfortable way to get to orbit, the beanstalk is also the slowest, taking approximately five days to make the journey from the surface to geosynchronous orbit. The beanstalk capsule is self-propelled, although it derives its power from the beanstalk itself. In an emergency, onboard batteries can provide enough power to reach safety but at less than half the normal speed. While most passenger capsules have a steward to attend to guests, no cooking is actually done on the vessel but facilities are available. Instead, pre-packaged food is prepared and served automatically.

Cargo capsules are similar in size and carry 95 tons of cargo.

TL: 12

First Example Laid Down: 2275

Last Example Laid Down: In Production

Number Produced: 400+

Producing Nation: France

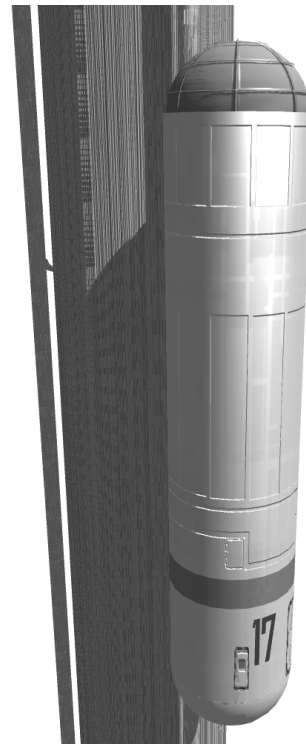

### Beanstalk Passenger Capsule

| Hull                   |                      |   | Size (tons) | Cost (MLv)     |
|------------------------|----------------------|---|-------------|----------------|
| 100 ton hull           | Hull                 | 2 |             | 1.0            |
|                        | Structure            | 2 |             |                |
| Streamlining           | Standard             |   |             | 0.1            |
| Armour                 | 0                    |   |             |                |
| Heat Shielding         |                      |   |             |                |
| Stutterwarp Drive      | Unloaded             | 0 |             |                |
|                        | Loaded               | 0 |             |                |
|                        | Tactical             | 0 |             |                |
| Reaction Drive         | Electric Motors      |   | 8           | 2              |
| Power Plant            | Powered by Beanstalk |   |             |                |
| Radiators              | N/A                  |   |             |                |
| Cockpit                | 2 Crew               |   |             |                |
| Computer               |                      |   |             |                |
| Electronics/Sensors    |                      |   |             |                |
| Fuel                   |                      |   |             |                |
| Cargo                  |                      |   | 10          |                |
| Staterooms             | 20                   |   | 80          | 2              |
| Recreation Facilities  |                      |   | 2           | 0.01           |
| Maintenance Cost       |                      |   |             | Lv4000/month   |
| Life Support Cost      |                      |   |             | Lv40,000/month |
| Total Tonnage and Cost |                      |   | 100         | MLv5.11        |

- 1. Central Elevator
- 2. Loungers
- 3. Emergency Thru Deck Access

**Observation Deck  
Level 1**

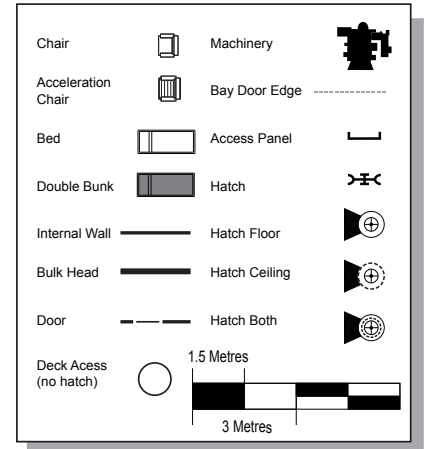
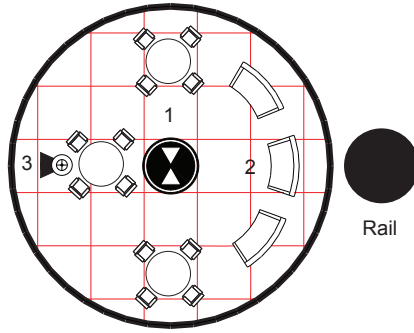

- 1. Central Elevator
- 2. Lower Dining Area
- 3. Generator / Motor Room A
- 4. Emergency Thru Deck Access
- 5. Storage Room
- 6. Life Support
- 7. Control / Communications

**Control Deck  
Level 2**

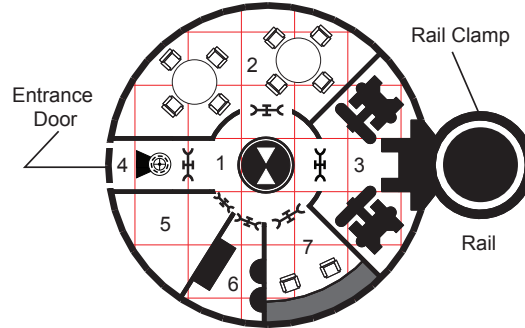

**Beanstalk Passenger  
Capsule**

- 1. Central Elevator
- 2. Bathroom
- 3. Emergency Thru Deck Access
- 4. Storage Locker / Emergency Equipment
- 5. Stateroom

**Living Quarters  
Levels 3 - 6**

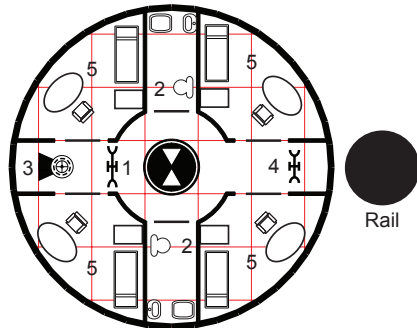

- 1. Central Elevator
- 2. Cargo Bay
- 3. Generator / Motor Room B
- 4. Emergency Thru Deck Access

**Cargo Deck  
Level 7**

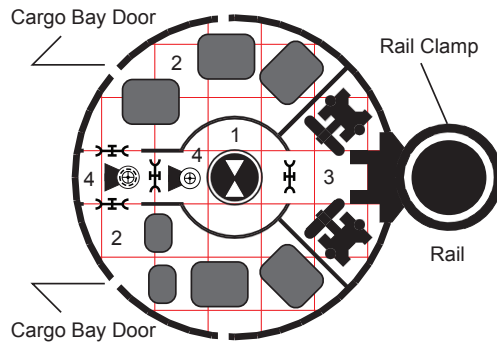

- 1. Central Elevator
- 2. Emergency Thru Deck Access & Emergency Exit
- 3. Floor Viewports

**Lower Observation deck  
Levels 8**

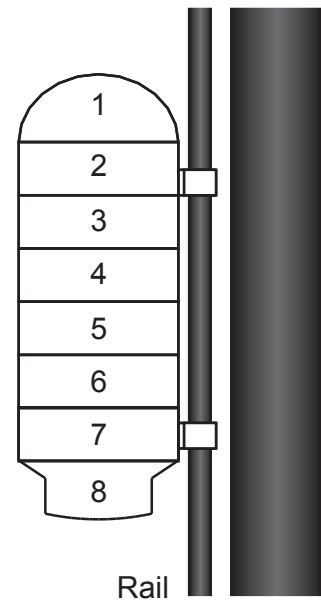
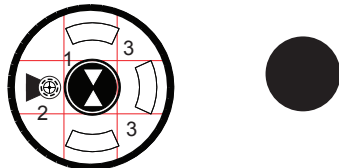

Beanstalk

# COMMERCIAL STARSHIPS

## THOREZ-CLASS COURIER

The Thorez-class courier was originally designed for short-duration courier missions. The hull has proved to be extremely flexible, however and variants of this design are spread all over charted space, serving as small tramp cargo vessels, couriers and even privateers. Powered by air-breathing thrusters, the Thorez can manage an unassisted takeoff from most worlds with normal gravity but often requires the use of boosters for use on high gravity planets. The thruster and stutterwarp cannot be run at the same time as the Thorez does not produce enough power.

TL: 10

First Example Laid Down: 2224

Last Example Laid Down: 2292

Number Produced: 65+

Producing Nation: France



### Thorez-class Courier

| Hull                   |                     |         | Size (tons) | Cost (MLv)     |
|------------------------|---------------------|---------|-------------|----------------|
| 200 ton hull           | Hull                | 4       |             | 4.4            |
|                        | Structure           | 4       |             |                |
| Streamlining           | Hybrid Lifting Body |         | 2           | 0.44           |
|                        | STOL                |         | 4           | 0.48           |
| Landing Roll           |                     |         |             |                |
| Take-Off Roll          |                     |         |             |                |
| Armour                 | 0                   |         |             |                |
| Heat Shielding         |                     |         |             | 0.2            |
| Stutterwarp Drive      | Unloaded            | 1.50    | 0.58        | 1.75           |
| New Commercial F       | Loaded              | 1.36    |             |                |
|                        | Tactical            | 3       |             |                |
| Reaction Drive         | Thruster A          | 1 G ACC | 2           | 4              |
| Power Plant            | MHD Turbine F       |         | 0.95        | 0.2            |
| Radiators              | Radiators F         |         | 0.09        | 0.05           |
| Bridge                 |                     |         | 10          | 1              |
| Computer               | 2/bis               |         |             | 0.16           |
| Software               | Stutterwarp/B       |         |             | 0.2            |
|                        | Library             |         |             |                |
|                        | Manoeuvre/0         |         |             |                |
| Electronics/Sensors    | Basic Civ           |         | 1           |                |
| Fuel                   | Thruster            | 9 hours | 28          |                |
|                        | Power Plant         | 14 days | 24          |                |
| Cargo                  |                     |         | 63          |                |
| Staterooms             | 16                  |         | 64          | 1.6            |
| Other Fixtures         | None                |         |             |                |
| Spin Habitat           | None                |         |             |                |
| Comfort                | -2                  |         |             |                |
| Maintenance Cost       |                     |         |             | Lv10,000/month |
| Life Support Cost      |                     |         |             | Lv32,000/month |
| Total Tonnage and Cost |                     |         | 400         | MLv14.48       |

# Thorez Class Courier

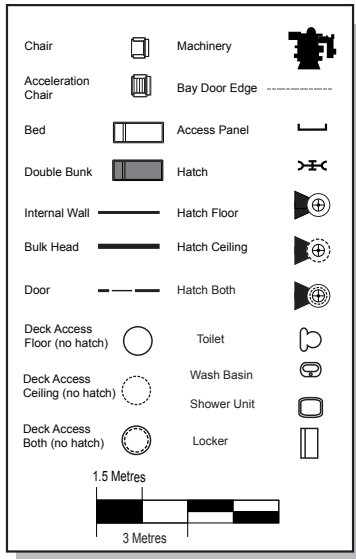

1. Sensors
2. Forward Thruster
3. Life Support
4. Airlock
5. Bridge Access
6. Lower Deck Access
7. Staterooms (8)
8. Lounge Area
9. Galley
10. Head
11. Utility Room
12. MHD & Stutterwarp

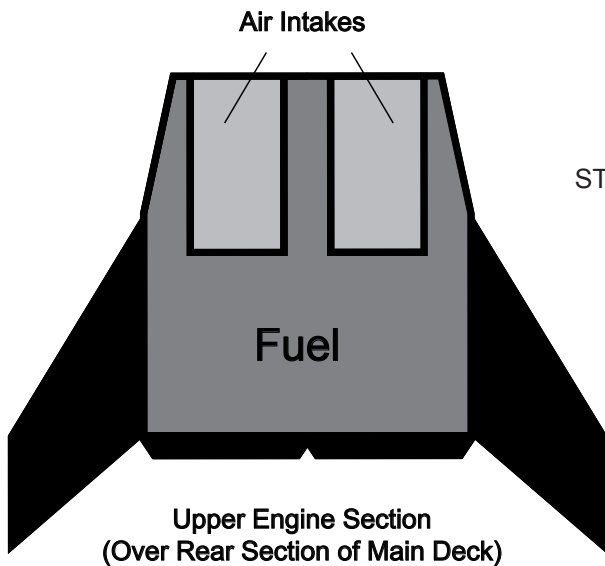
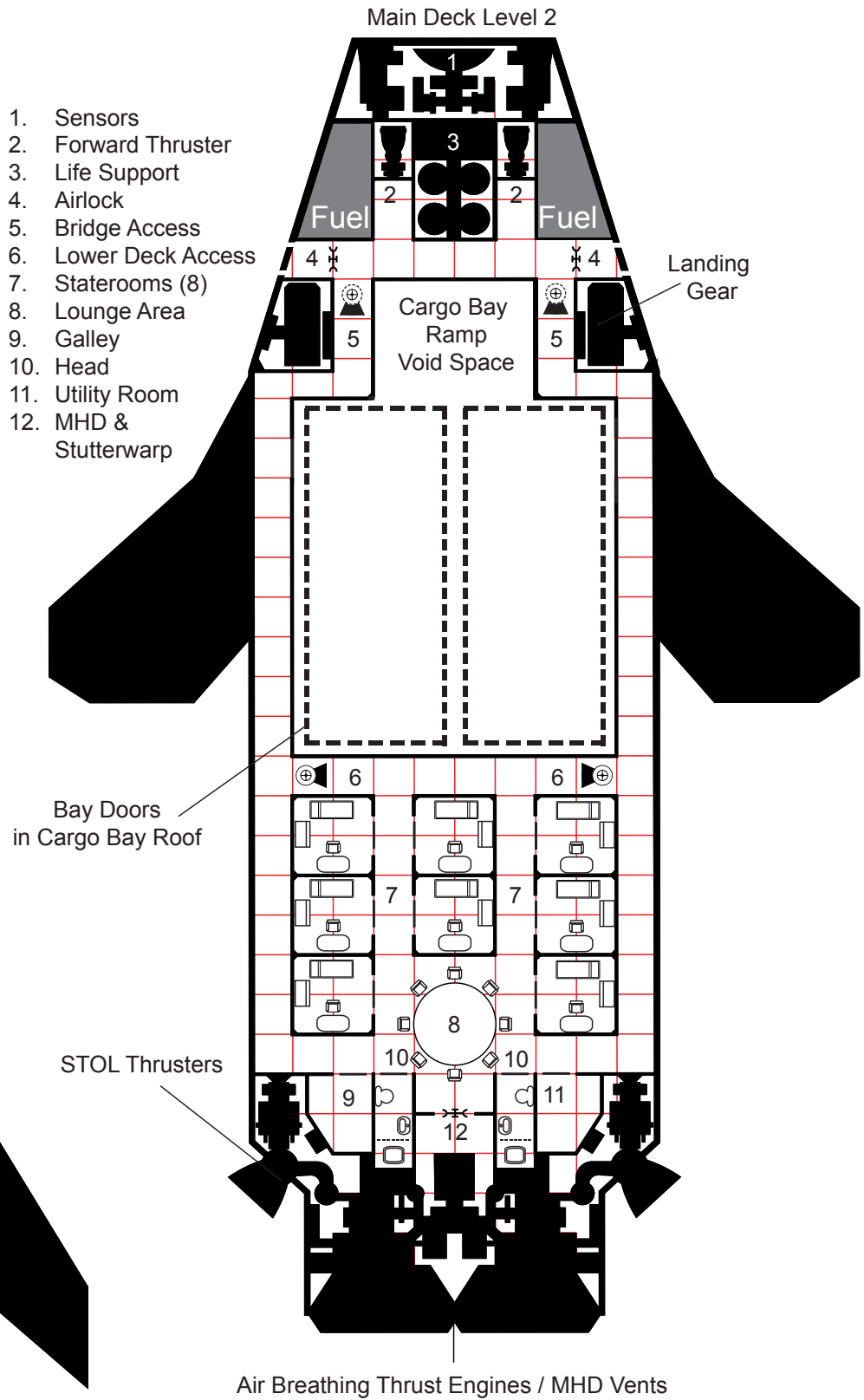

# Thorez Class Courier

Bridge Deck Level 1

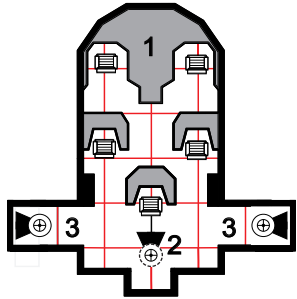

- 1. Bridge
- 2. Emergency Escape Hatch
- 3. Lower Deck Access

|                                |  |               |  |
|--------------------------------|--|---------------|--|
| Chair                          |  | Machinery     |  |
| Acceleration Chair             |  | Bay Door Edge |  |
| Bed                            |  | Access Panel  |  |
| Double Bunk                    |  | Hatch         |  |
| Internal Wall                  |  | Hatch Floor   |  |
| Bulk Head                      |  | Hatch Ceiling |  |
| Door                           |  | Hatch Both    |  |
| Deck Access Floor (no hatch)   |  | Toilet        |  |
| Deck Access Ceiling (no hatch) |  | Wash Basin    |  |
| Deck Access Both (no hatch)    |  | Shower Unit   |  |
|                                |  | Locker        |  |

1.5 Metres  
3 Metres

Lower Deck Level 3

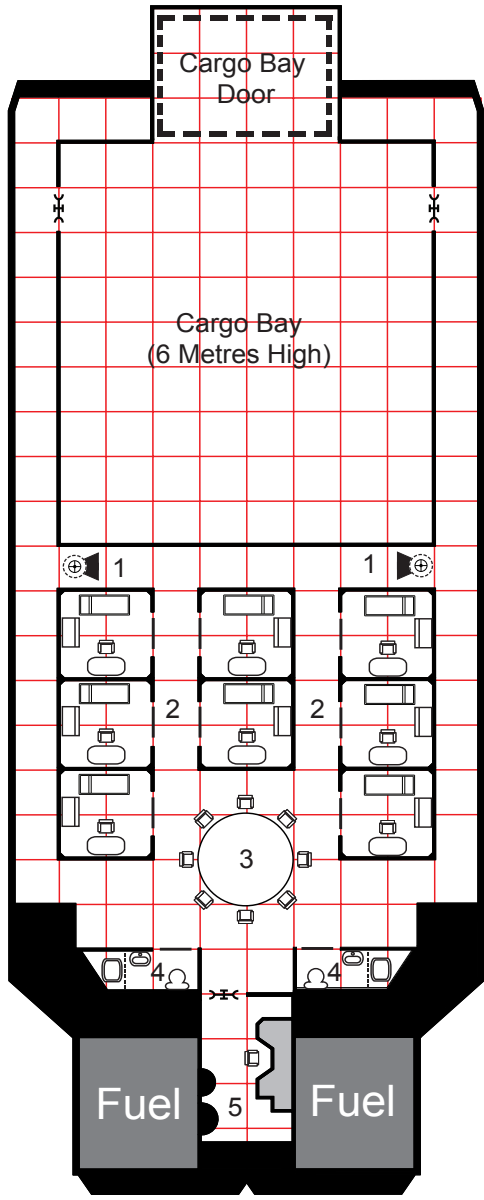

- 1. Upper Deck Access
- 2. Staterooms (8)
- 3. Lounge
- 4. Head
- 5. Engineering Station

Fuel Tank Deck Level 4



Landing Gear



## ANJOU-CLASS CARGO HAULER

The Anjou is a basic cargo vessel in a simple, straight-forward design. Equipped with a small-diameter gravity wheel for crew comfort, the Anjou also sees some use as a basic passenger liner. This cylindrical design is manufactured all over human space, in licensed-built models and out-and-out pirated copies. It is a favourite vessel of the Libertine traders and makes up roughly half of all their trading vessels

### Crew:

|                |    |
|----------------|----|
| Bridge         | 12 |
| Engineering    | 3  |
| Cargo Handlers | 4  |
| Steward        | 2  |

TL: 10

First Example Laid Down: 2291

Last Example Laid Down: In production

Number Produced: 78+

Producing Nation: All

### Anjou-Class Cargo Hauler

| Hull                   |               |         | Size (tons) | Cost (MLv)      |
|------------------------|---------------|---------|-------------|-----------------|
| 2,000 ton hull         | Hull          | 40      |             | 100             |
|                        | Structure     | 40      |             |                 |
| Armour                 | 0             |         |             |                 |
| Stutterwarp Drive      | Unloaded      | 1.84    | 0.58        | 1.75            |
| New Commercial F       | Loaded        | 0.85    |             |                 |
|                        | Tactical      | 3       |             |                 |
| Reaction Drive         | None          |         |             |                 |
| Power Plant            | MHD Turbine H |         | 4.29        | 0.38            |
| Radiators              | Radiators H   |         | 0.43        | 0.05            |
| Bridge                 |               |         | 40          | 10              |
| Computer               | 2/bis         |         |             | 0.16            |
| Software               | Stutterwarp/B |         |             | 0.2             |
|                        | Library       |         |             |                 |
|                        | Manoeuvre/0   |         |             |                 |
| Electronics/Sensors    | Basic Civ     | DM -2   | 1           | 0.05            |
| Fuel                   | Power Plant   | 19 days | 91          |                 |
| Cargo                  |               |         | 1,712       |                 |
| Staterooms             | 25            |         | 100         | 2.5             |
| Other Fixtures         | None          |         |             |                 |
| Spin Habitat           | Double Hull   |         | 10          | 0.5             |
| Comfort                | +1            |         |             |                 |
| Maintenance Cost       |               |         |             | Lv10,000/month  |
| Life Support Cost      |               |         |             | Lv100,000/month |
| Total Tonnage and Cost |               |         | 2,000       | MLv115.75       |

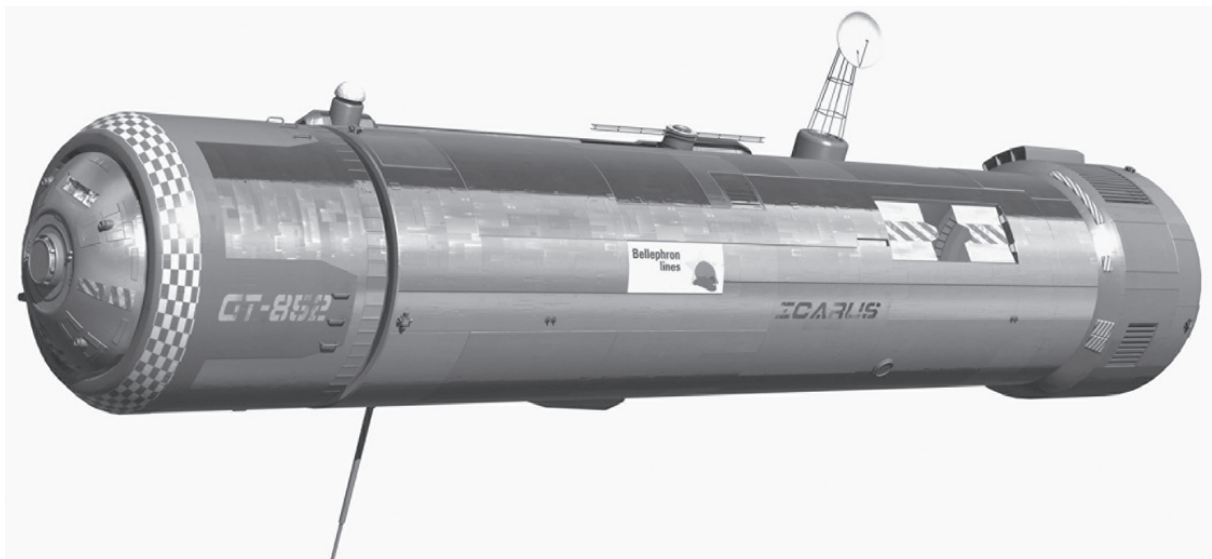



# Anjou Class Freighter

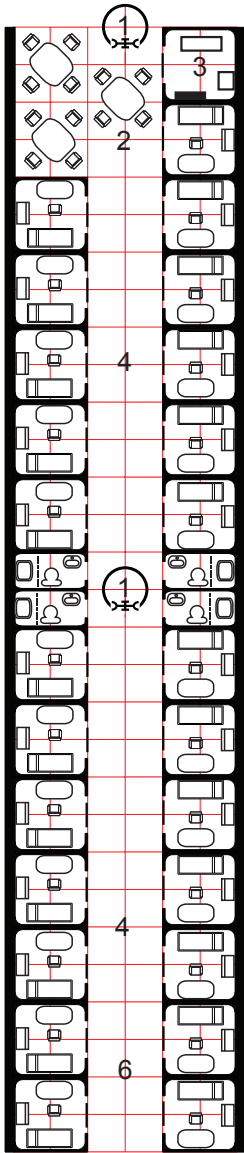

Spin Habitat Deck

Engineering Deck

1. Access Tube
2. Eating Area
3. Galley
4. Staterooms
5. Head / Washroom
6. Common Area

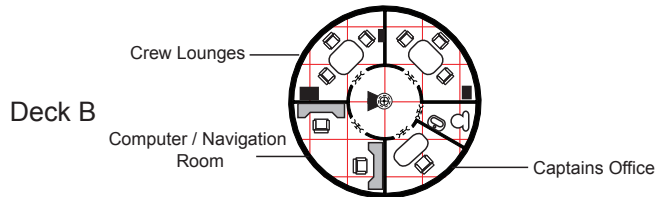
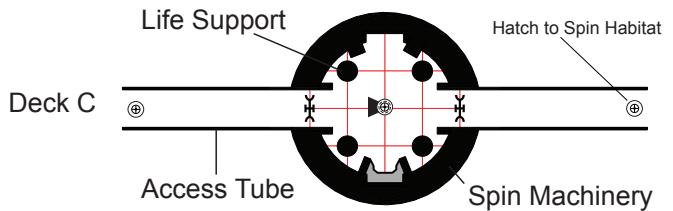
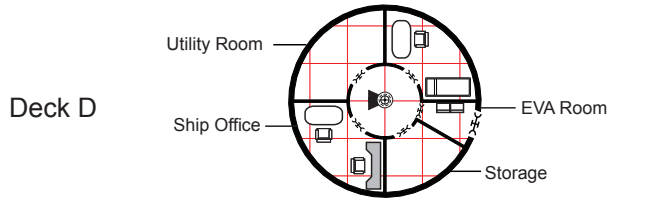
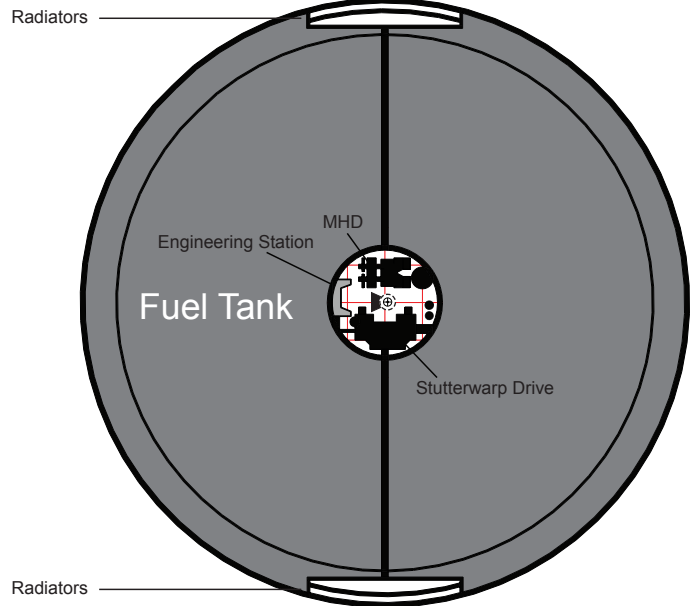

Deck A  
Bridge Deck

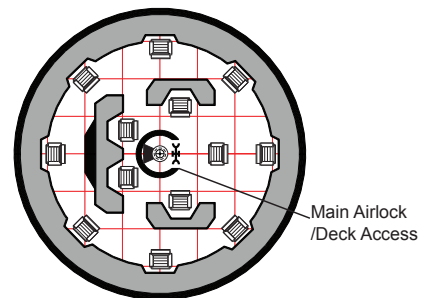

|                                |  |               |  |
|--------------------------------|--|---------------|--|
| Chair                          |  | Machinery     |  |
| Acceleration Chair             |  | Bay Door Edge |  |
| Bed                            |  | Hatch Side    |  |
| Double Bunk                    |  | Hatch         |  |
| Internal Wall                  |  | Hatch Floor   |  |
| Bulk Head                      |  | Hatch Ceiling |  |
| Door                           |  | Hatch Both    |  |
| Deck Access Floor (no hatch)   |  | Toilet        |  |
| Deck Access Ceiling (no hatch) |  | Wash Basin    |  |
| Deck Access Both (no hatch)    |  | Shower Unit   |  |
|                                |  | Locker        |  |

1.5 Metres  
3 Metres

# Anjou Class Freighter

Deck Diagram  
(Side View)

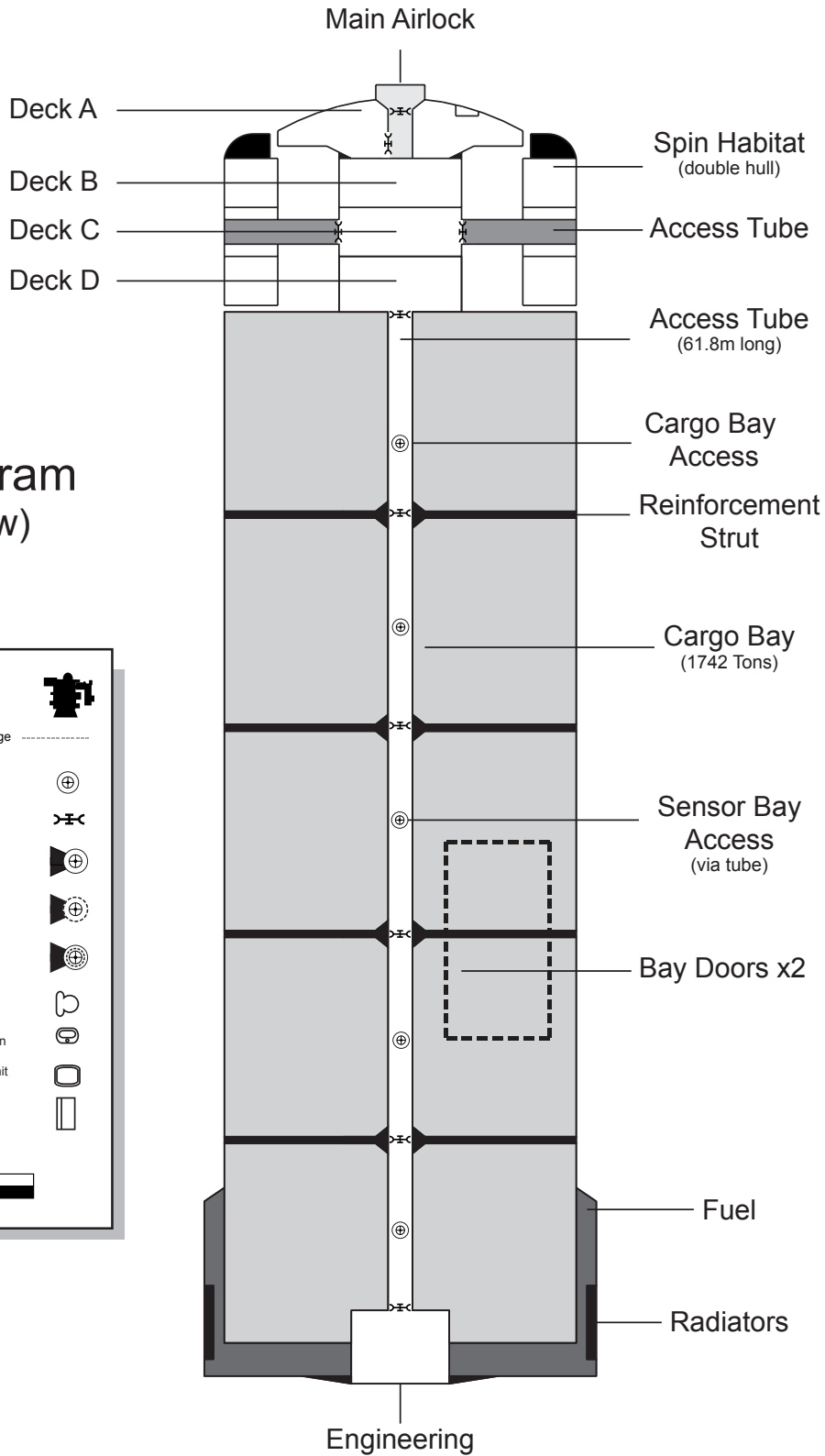
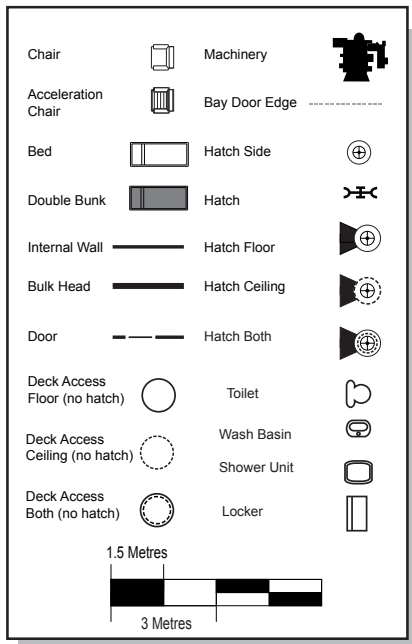

# SURVEY VESSELS

## TRILON ASSOCIATES SYSTEM-C SPECIAL SERVICES VESSEL, SSV-21

The SSV-21 grew out of a Trilon need for a sophisticated vessel that could handle such tasks as first contact missions and extended surveys of living worlds.

The SSV-21 relies on a closed-cycle fuel cell Power Plant. Fuel cells are normally used in small military vessels for their lower radiated signature but the high cost typically keeps them out of civilian vessels. A closed-cycle plant like the one found on the SSV-21 retains its fuel supply after use and can simply deploy a solar array to crack the water exhaust back into hydrogen and oxygen. This way, it does not need to rely on bases and need not spend a great deal of time searching for water or ice to crack into fuel. Using a closed system greatly extends the vessel's operat-

### Crew:

|             |    |
|-------------|----|
| Bridge      | 12 |
| Engineering | 3  |
| Steward     | 1  |
| Medics      | 1  |
| Facilities  | 2  |
| Scientists  | 10 |

ing time but some loss does happen with each cycle. A separate fuel refining plant is not necessary, as the fuel cell itself can simply be operated in reverse.

The vessel's active sensor array cannot be used while the ship is reprocessing water back into fuel, as the power requirements are too high. It takes a week to crack the full load of fuel using the vessel's solar array.

### Trilon SSV-21 Survey Vessel

| Hull                   |                            |             | Size (tons) | Cost (MLv)   |
|------------------------|----------------------------|-------------|-------------|--------------|
| 600 ton hull           | Hull                       | 12          |             | 24           |
|                        | Structure                  | 12          |             |              |
| Armour                 | 0                          |             |             |              |
| Stutterwarp Drive      | Unloaded                   | 1.40        | 0.89        | 2.66         |
| New Commercial H       | Loaded                     | 1.35        |             |              |
|                        | Tactical                   | 3           |             |              |
| Reaction Drive         | None                       |             |             |              |
| Power Plant            | Fuel Cell H                | Closed      | 4.29        | 60           |
| Radiators              | Radiators H                |             | 0.43        | 0.05         |
| Solar Panels           |                            |             | 0.5         | 0.01         |
| Bridge                 |                            |             | 20          | 3.0          |
| Computer               | Model 2                    | Rating 10   |             | 0.16         |
| Software               | Stutterwarp/B              |             |             | 0.2          |
|                        | Library                    |             |             |              |
|                        | Manoeuvre/0                |             |             |              |
| Electronics/Sensors    | Advanced                   | DM -2       | 3           | 2            |
|                        | Survey Sensors             |             | 10          | 10           |
| Fuel                   | Power Plant                | 6 weeks     | 160.38      |              |
| Cargo                  |                            |             | 85          |              |
| Staterooms             | 31                         |             | 124         | 3.1          |
| Other Fixtures         | Theatre                    | Seats 20    | 15          | 0.3          |
|                        | Laboratories               | 6           | 24          | 6            |
|                        | Library                    |             | 4           | 4            |
|                        | Hanger for 2 landing craft | Full Hanger | 115         | 3            |
| Spin Habitat           | Spin Capsules              |             | 33.4        | 2.15         |
| Comfort                | +2                         |             |             |              |
| Maintenance Cost       |                            |             |             | 0.0099/month |
| Life Support Cost      |                            |             |             | 0.248/month  |
| Total Tonnage and Cost |                            |             | 600         | MLv120.63    |

TL: 11

First Example Laid Down: 2285

Last Example Laid Down: In Production

Number Produced: 13

Producing Nation: America/Trilon



1. Bridge
2. Storage
3. Head
4. Hangar Access 1
5. Captain's Office
6. Library
7. Med Bay
8. Utility Room
9. Laboratory
10. Hangar Access 2 /Upper Airlock
11. Cargo Bay
12. Storage
13. Theatre
14. Spin Habitat Access
15. Emergency Lockers
16. Engineering Control / Maintenance Area
17. Engineering Space

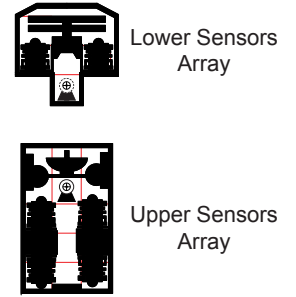

### SSV-21 Class Survey Vessel

Hangar & Cargo Bay Underneath Front Section

Cargo stored in upper bay, hangar section, storage rooms and along spin habitat spine

Bays 6m High

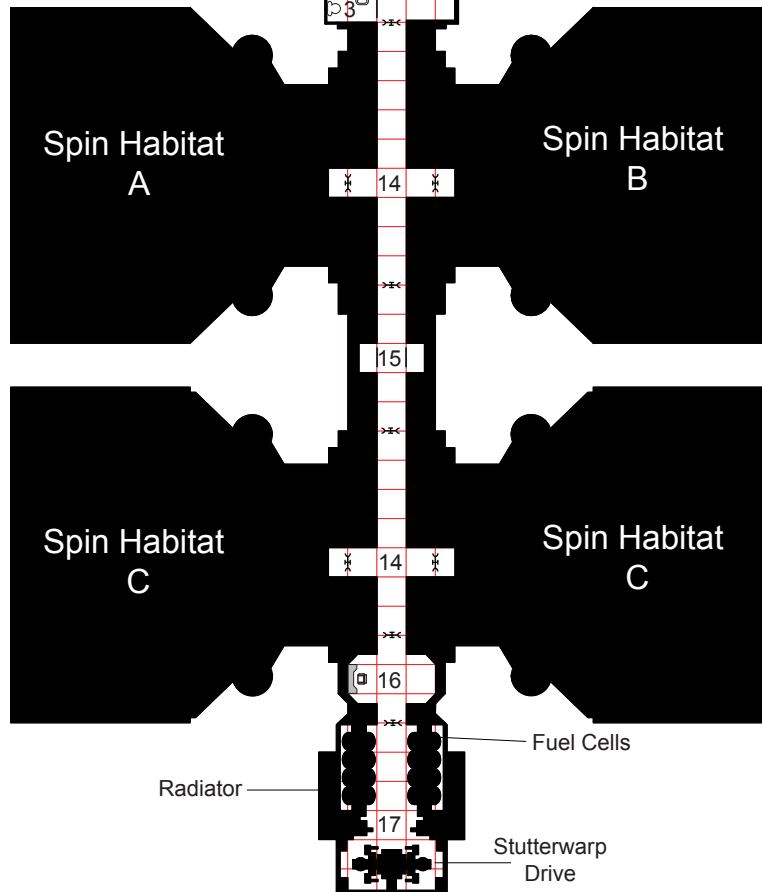
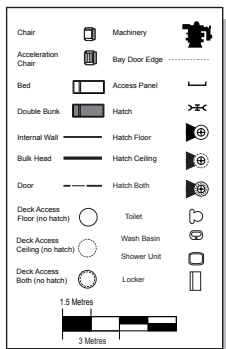
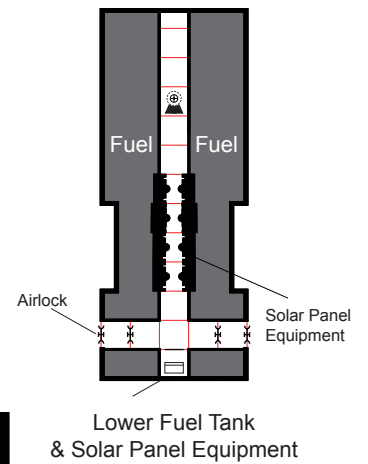

### Spin Habitat A

- 1. Staterooms
- 2. Head
- 3. Storage Locker
- 4. Galley
- 5. Lounge
- 6. Crew Mess

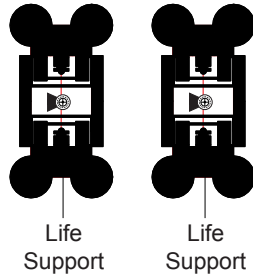
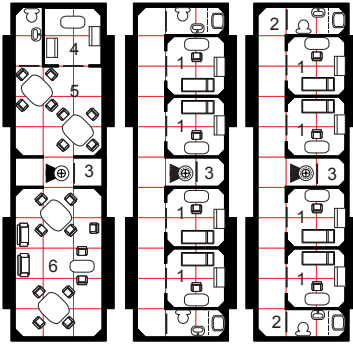

### Spin Habitat C

- 1. Staterooms
- 2. Head
- 3. Storage Locker
- 4. Galley
- 5. Lounge
- 6. Crew Mess

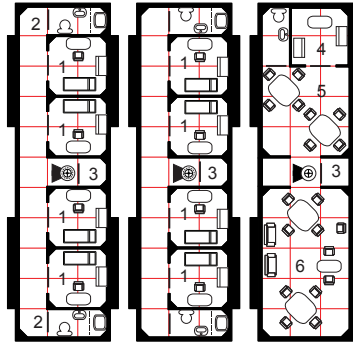

### Spin Habitat B

- 1. Staterooms
- 2. Head
- 3. Storage Locker
- 4. Utility Room
- 5. Galley
- 6. Lounge
- 7. Crew Mess

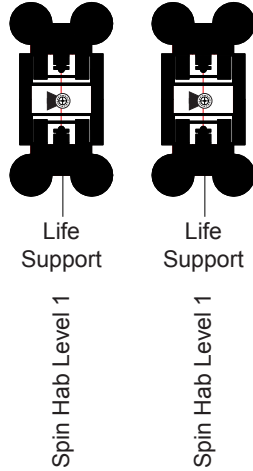
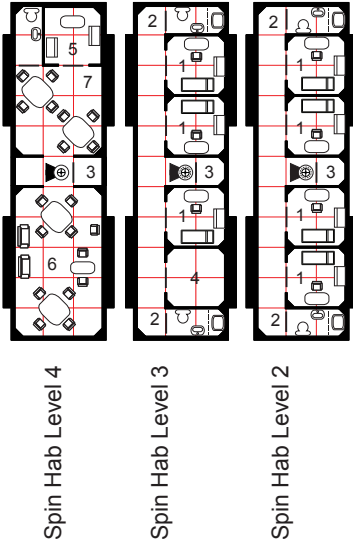

### Spin Habitat D

- 1. Staterooms
- 2. Head
- 3. Storage Locker
- 4. Utility Room
- 5. Galley
- 6. Lounge
- 7. Crew Mess

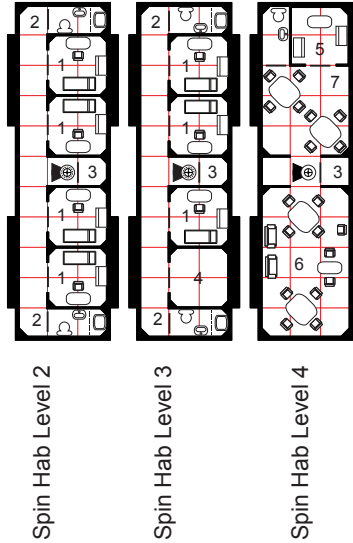

## SSV-21 Class Survey Vessel

### SLV Hangar Level 1

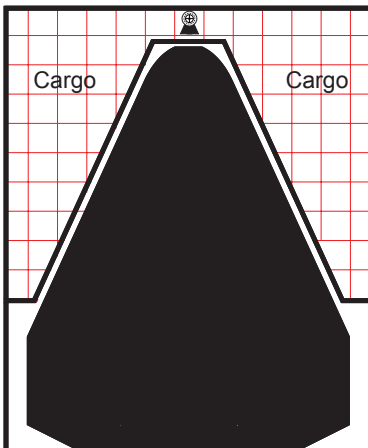

### SLV Hangar Level 2

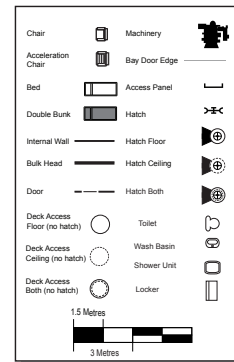
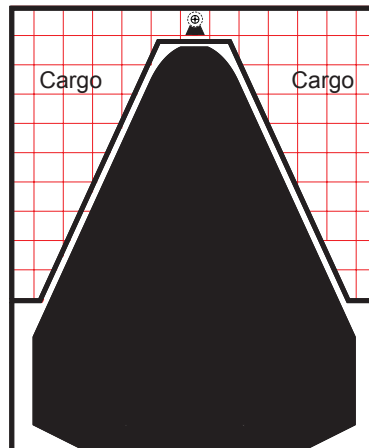

## THE LANDERS

The SSV-21 has 100 dtons of space available for small craft and the 50 dton SLV-50 (Scout Landing Vessel, 50 tons) is the most popular. The SLV-50 carries a heavy ATV (6 dtons) in a vehicle bay, along with an expanding base (2 dtons), a fuel station (1 dton) and a variety of stores for a ground party in its cargo bay. Many use part of the cargo capacity to carry a small multi-environment gyrocopter.

The SLV-50 itself carries a basic array of survey sensors and can be used to extend the ground party's survey range 100 fold.

TL: 11

First Example Laid Down: 2291

Last Example Laid Down: In Production

Number Produced: 44

Producing Nation: America/Trilon

### Trilon SLV-50 Exploratory Lander

| Hull                   |                           |                  | Size (tons) | Cost (MLv)  |
|------------------------|---------------------------|------------------|-------------|-------------|
| 50 ton hull            | Hull                      | 1                |             | 0.75        |
|                        | Structure                 | 1                |             |             |
| Streamlining           | Lifting Body              |                  | 0.1         | 0.5         |
|                        | VTOL                      |                  | 5           | 0.375       |
| Landing Roll           | 0                         |                  |             |             |
| Take-off Roll          | 0                         |                  |             |             |
| Armour                 | 0                         |                  |             |             |
| Heat Shielding         |                           |                  |             | 0.05        |
| Stutterwarp Drive      | Unloaded                  | 0                |             |             |
|                        | Loaded                    | 0                |             |             |
|                        | Tactical                  | 0                |             |             |
| Reaction Drive         | Air-Breathing Thruster sD | 1 G Acceleration | 2.0         | 7.2         |
| Power Plant            | MHD Turbine A             |                  | 0.48        | 0.10        |
| Radiators              | Radiators A               |                  | 0.05        | 0.0025      |
| Cockpit                | 2 Crew                    |                  | 3           | .25         |
| Computer               | Model /2                  |                  |             |             |
| Electronics/Sensors    | Advanced Sensors          |                  | 3           | .2          |
| Fuel                   | Thruster Fuel             | 6 hours          | 9           |             |
|                        | Power Plant Fuel          | 7 days           | 5.88        |             |
| Cargo                  |                           |                  | 7.5         |             |
| Passenger Couches      | 10                        |                  | 5           | 3.0         |
| Other Fixtures         | Inflatable Base           |                  | 2           |             |
|                        | Crawler                   |                  | 6           |             |
|                        | Fuel Station              |                  | 1           |             |
| Maintenance Cost       |                           |                  |             | 0.008/month |
| Life Support Cost      |                           |                  |             | 2/month     |
| Total Tonnage and Cost |                           |                  | 50          | MLv12.43    |

# SLV-50 Lander

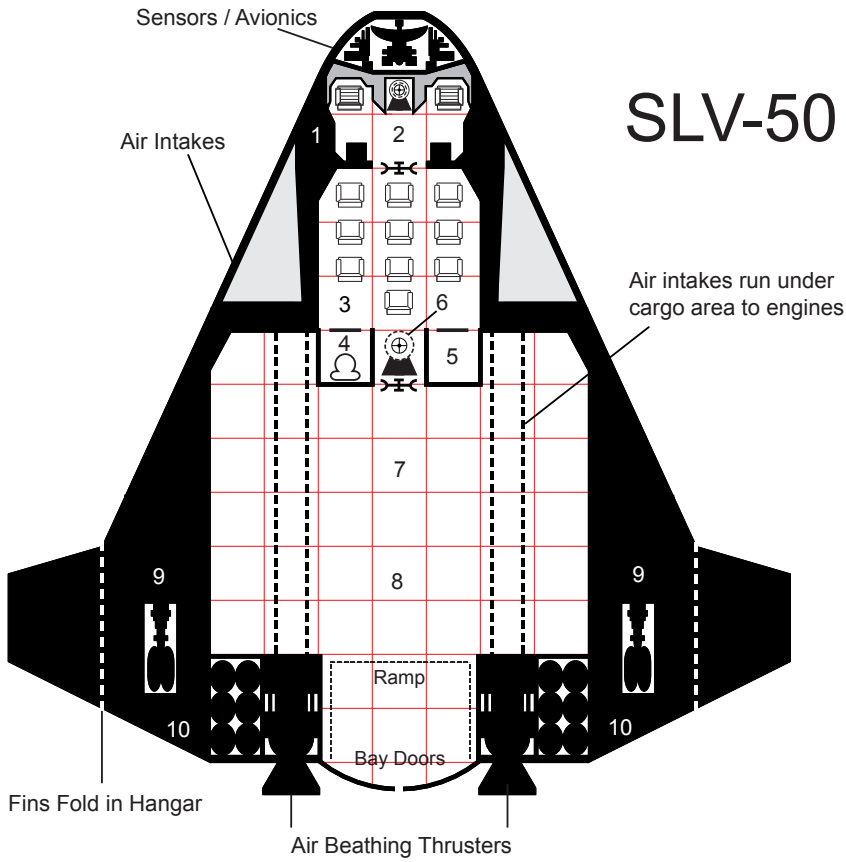

**Main Deck  
Level 2**

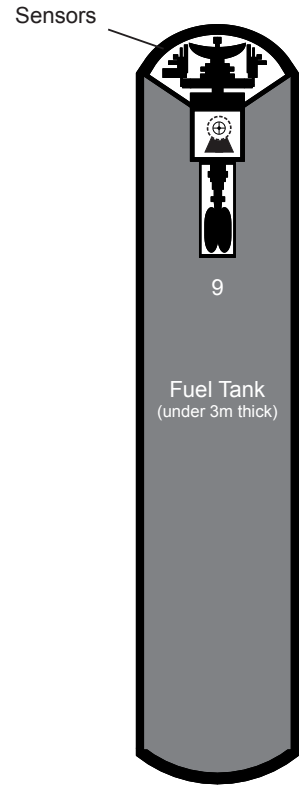

**Fuel Deck  
Level 1**

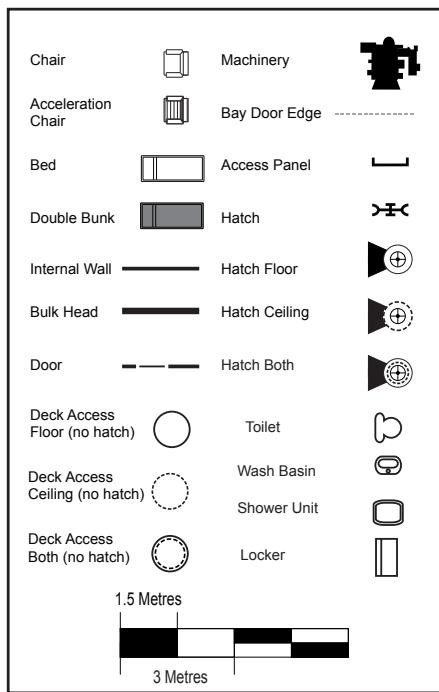

1. Cockpit
2. Lower Section Access / Escape Hatch
3. Passenger Area
4. Head
5. Emergency Locker
6. Upper Exit / SSV Access Point
7. Cargo Area / Base Storage
8. ATV Area
9. Landing Gear
10. Life Support

### CITY-CLASS PASSENGER LINER

The City-class liner is justifiably famous throughout human space. There are 12 of these vessels on the more lucrative runs in human space, including Earth-Beta Canum, Earth-Ellis, Earth-Nibelungen and so on.

In addition to the passenger cabins, these ships have a small swimming pool and a park, along with a fully equipped gymnasium and extensive electronic library. The two landing craft are used for a variety of purposes, including ferrying passengers and moving cargo.

Like most passenger spacecraft, the City-class it required to carry lifeboats. There is sufficient space in the boats to carry 600 people, although the ship has a complement of over 700, including crew.

### Crew:

|               |    |
|---------------|----|
| Bridge        | 12 |
| Engineering   | 3  |
| Steward       | 73 |
| Medics        | 15 |
| Facilities    | 14 |
| Ship Security | 15 |

TL: 11

First Example Laid Down: 2278

Last Example Laid Down: 2292

Number Produced: 12

Producing Nation: France

| City-class Passenger Liner |                         |               | Size (tons) | Cost (MLv) |
|----------------------------|-------------------------|---------------|-------------|------------|
| Hull                       |                         |               |             |            |
| 5,000 ton hull             | Hull                    | 100           |             | 250        |
|                            | Structure               | 100           |             |            |
| Armour                     | 0                       |               |             |            |
| Stutterwarp Drive          | Unloaded                | 0.65          | 0.58        | 1.75       |
| Old Commercial H           | Loaded                  | 0.63          |             |            |
|                            | Tactical                | 1             |             |            |
| Reaction Drive             | None                    |               |             |            |
| Power Plant                | MHD Turbine H           |               | 4.29        | 0.38       |
| Radiators                  | Radiators H             |               | 0.43        | 0.05       |
| Bridge                     |                         |               | 60          | 250        |
| Computer                   | 2                       |               |             | 0.16       |
| Software                   | Stutterwarp/A           |               |             | 0.1        |
|                            | Library                 |               |             |            |
|                            | Intellect Rating 10     |               |             | 1          |
|                            | Manoeuvre/0             |               |             |            |
| Electronics/Sensors        | Basic Civ               | DM -2         | 1           | 0.05       |
| Fuel                       | Power Plant             | 28 days       | 141.12      |            |
| Cargo                      |                         |               | 700         |            |
| Staterooms                 | 164                     |               | 656         | 16.4       |
| Luxury Suites              | 250                     |               | 2,000       | 125        |
| Other Fixtures             | 400 Escape Pods         |               | 200         | 40         |
|                            | 3 Theatres for 150      |               | 338         | 6.8        |
|                            | Park                    |               | 100         | 10         |
|                            | 3 Swimming Pools        |               | 150         | 1.5        |
|                            | Luxury Dining 250       |               | 63          | 3.13       |
|                            | 3 Libraries             |               | 36          | 36         |
|                            | Standard Hanger         | 2 Spaceplanes | 208         |            |
| Spin Habitat               | Double Hull (3535 tons) | 0.65G         | 340.60      | 0.5        |
| Comfort                    | +4                      |               |             |            |
| Maintenance Cost           |                         |               |             | 0.21/month |
| Life Support Cost          |                         |               |             | 10/month   |
| Total Tonnage and Cost     |                         |               | 5,000       | MLv742.82  |



# SYSTEM SHIPS

System ships are the vessels that ply the space between worlds within star systems. Typically using very low-powered stutterwarp drives, system-ships are more economical to run for the short in-system routes.

## **ASTRAL-CLASS BULK CARRIER**

Using a low-powered stutterwarp drive, the Astral can transport over 1,600 dtons within the confines of a solar system. The ship itself is a modular freighter, carrying its cargo externally along the cargo spine.

|             |    |
|-------------|----|
| Crew        |    |
| Bridge      | 12 |
| Engineering | 3  |
| Steward     | 1  |
| Students    | 12 |
| Facilities  | 1  |

Most system ships are robotic vessels and many Astrals have been converted to robotic operations or, if crewed, operate with far fewer than the mandated crew numbers. However, some merchant concerns use these slow, lumbering system ships as training vessels, both for new hires and for experienced crew moving up into command positions. If nothing else, an Astral teaches patience.

The ship can carry 275 tons in its internal pressurised hold and an additional 1,500 tons in modules along the spine.

TL: 10  
 First Example Laid Down: 2207  
 Last Example Laid Down: In Production  
 Number Produced: 220+  
 Producing Nation: France

### **Astral-class Bulk Carrier**

| Hull                   |                      |           | Size (tons) | Cost (MLv)   |
|------------------------|----------------------|-----------|-------------|--------------|
| 2,000 ton hull         | Hull                 | 40        |             | 157.5        |
|                        | Structure            | 40        |             |              |
|                        | Distributed, Modular | 1500 tons |             |              |
| Armour                 | 0                    |           |             |              |
| Stutterwarp Drive      | Unloaded             | 0.85      | 0.89        | 2.66         |
| Old Commercial A       | Loaded               | 0.44      |             |              |
|                        | Tactical             | 2         |             |              |
| Reaction Drive         | None                 |           |             |              |
| Power Plant            | MHD Turbine A        |           | 0.71        | 0.06         |
| Radiators              | Radiators A          |           | 0.07        | 0.0035       |
| Bridge                 |                      |           | 40          | 4            |
| Computer               | Model 1              | Rating 5  |             | 0.16         |
| Software               | Stutterwarp/A        |           |             | 0.1          |
|                        | Library              |           |             |              |
|                        | Manoeuvre/0          |           |             |              |
| Electronics/Sensors    | Basic Civilian       | DM -2     | 3           | 2            |
| Fuel                   | Power Plant          | 4 weeks   | 13.44       |              |
| Cargo                  |                      |           | 275         |              |
| Staterooms             | 30                   |           | 120         | 1.5          |
| Other Fixtures         | Theatre              | Seats 20  | 15          | 0.3          |
|                        | Library              |           | 4           | 4            |
| Spin Habitat           | Spin Capsules        |           | 28          | 1.4          |
| Comfort                | +1                   |           |             |              |
| Maintenance Cost       |                      |           |             | 0.0099/month |
| Life Support Cost      |                      |           |             | 0.248/month  |
| Total Tonnage and Cost |                      |           | 2,000       | MLv172.69    |

Lower Deck Forward Section

1. Suit Locker
2. Equipment Locker
3. Utility Room
4. Med Bay
5. Ship Office
6. Officers' Wardroom
7. Theatre

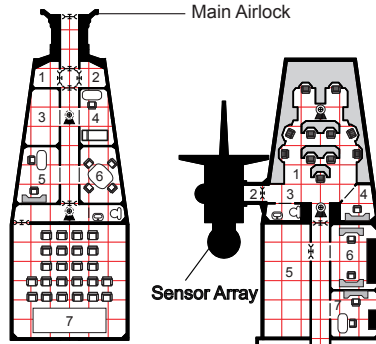

Upper Deck Forward Section

1. Bridge
2. Sensor Access
3. Head
4. Computer / Navigation Room
5. Secure Cargo Bay
6. Library
7. Cargo Master Office / Cargo Section Controls
8. Spin Machinery / Life Support

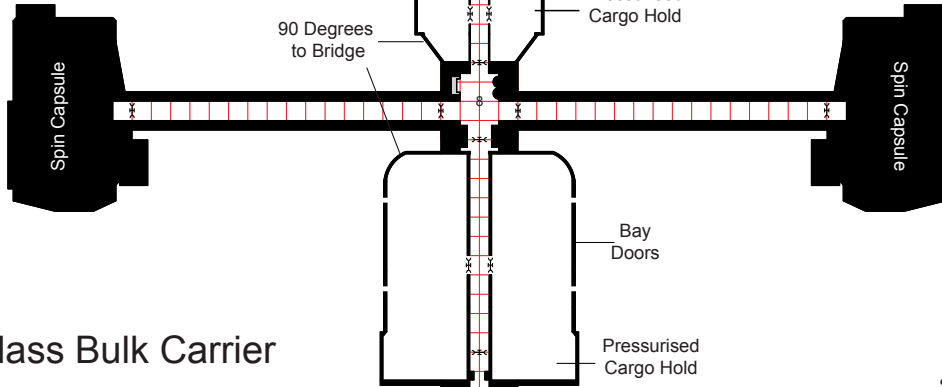
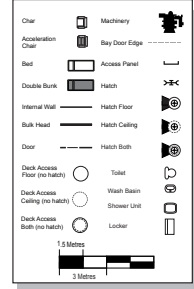

Astral Class Bulk Carrier

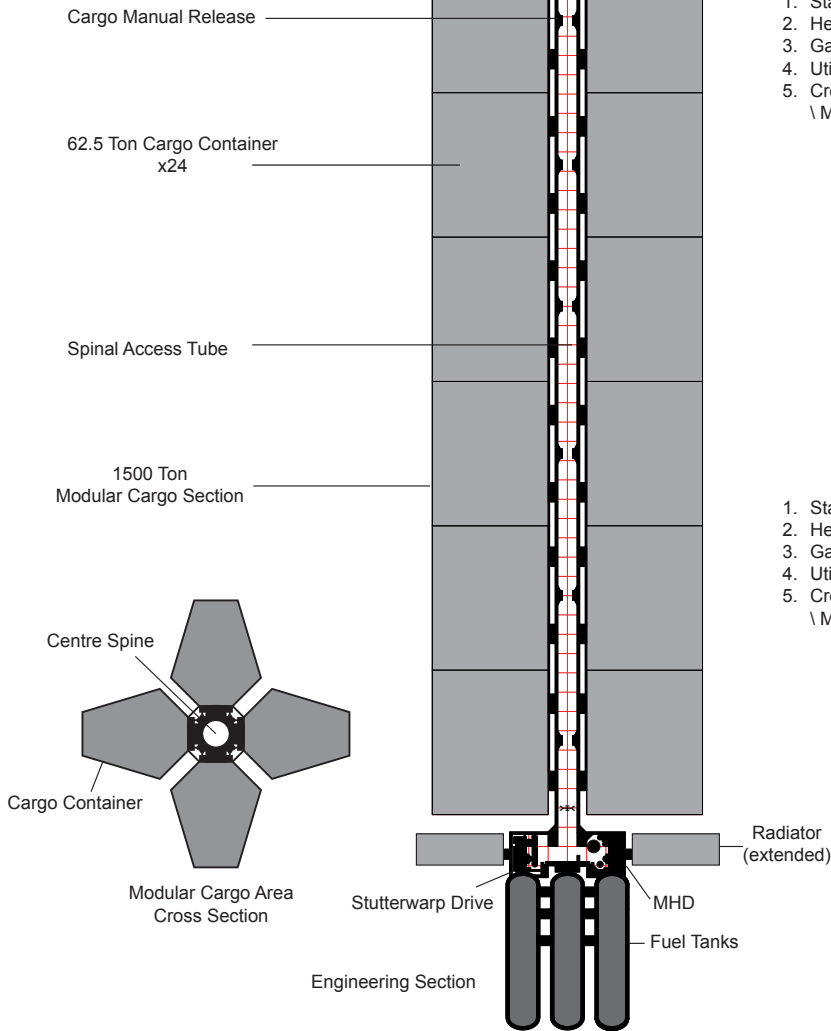

Spin Capsule A Decks

1. Staterooms
2. Head
3. Galley
4. Utility Rom
5. Crew Lounge \ Mess

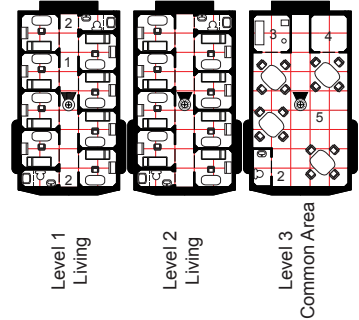

Spin Capsule B Decks

1. Staterooms
2. Head
3. Galley
4. Utility Rom
5. Crew Lounge \ Mess

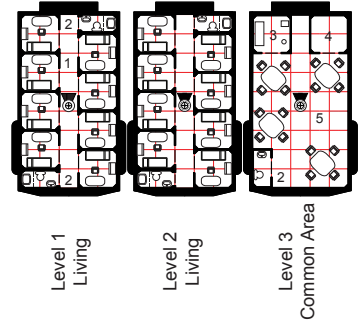

# MILITARY VESSELS

Most human fleets use a mix of multi-purpose warships of various sizes. There are some purpose-built specialist military craft but these are rare.

## CUTTER

Used as a general-purpose small craft, the cutter is stutterwarp capable but is not designed for interface operations. It possesses a thruster for precise orbital operations and boarding actions. It is used in ship-to-ship transfers orbital operations and customs duties. Despite being relatively fast for such a small vessel, it lacks endurance and is not suitable for interstellar journeys. In addition to the two flight crew, the cutter carries a crew of six inspection officers and/or marines.

TL: 12

First Example Laid Down: 2275

Last Example Laid Down: In production

Number Produced: 80+

Producing Nation: Various

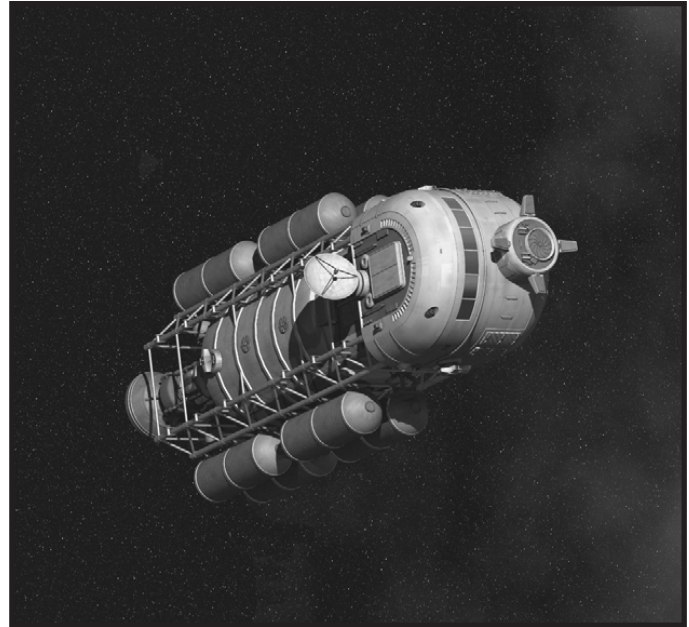

### Orbital Patrol Cutter

| Hull                   |                 |           | Size (tons) | Cost (MLv)   |
|------------------------|-----------------|-----------|-------------|--------------|
| 50 ton hull            | Hull            | 1         |             | 0.75         |
|                        | Structure       | 1         |             |              |
| Armour                 | 6               | Composite | 2.5         | 0.375        |
| Stutterwarp Drive      | Unloaded        |           | 0.70        | 2.1          |
| New Military F         | Loaded          | 2.32      |             |              |
|                        | Tactical        | 4         |             |              |
| Reaction Drive         | Thruster sD     | 1 G       | 2           | 3.5          |
| Power Plant            | MHD Turbine F   |           | 0.71        | 0.25         |
| Radiators              | Radiators F     |           | 0.07        | 0.035        |
| Cockpit                |                 |           | 3           | 0.25         |
| Computer               | Model 2         | Rating 10 |             | 0.16         |
| Software               | Stutterwarp/B   |           |             | 0.2          |
|                        | Library         |           |             |              |
|                        | Manoeuvre/O     |           |             |              |
| Electronics/Sensors    | Advanced        |           | 3           | 2            |
| Fuel                   | Thruster        | 10 hours  | 10          |              |
|                        | Power Plant     | 48 hours  | 3.36        |              |
| Cargo                  |                 |           | 3           |              |
| Passenger Couches      | 6               |           | 12          | 0.18         |
| Other Fixtures         | Autodoc         |           | 0.5         | 1            |
|                        | Airlock         |           | 1           | 0.2          |
|                        | Breaching Tube  |           | 3           | 3            |
| Probe Bay              | 5 Drones        |           | 1           | 0.5          |
|                        |                 | Aspects   |             |              |
| Weapon Mount 1         | Standard Turret | 1,2,3,5   | 1           | 0.5          |
|                        | EA-122 Laser    |           |             | 1.75         |
| Fire Control           | UTES            |           | 1           | 0.6          |
| Weapon Mount 2         | Standard Turret | 1,2,5,6   | 1           | 0.5          |
|                        | EA-122 Laser    |           |             | 1.75         |
| Fire Control           | UTES            |           | 1           | 0.6          |
| Spin Habitat           | None            |           |             |              |
| Comfort                | 0               |           |             |              |
| Maintenance Cost       |                 |           |             | Lv1400/month |
| Life Support Cost      |                 |           |             | Lv2000/month |
| Total Tonnage and Cost |                 |           | 50          | MLv19.7      |

## Main Deck Level 1

1. Bridge
2. Passenger Compartment
3. Cargo
4. Life Support
5. Engine Access

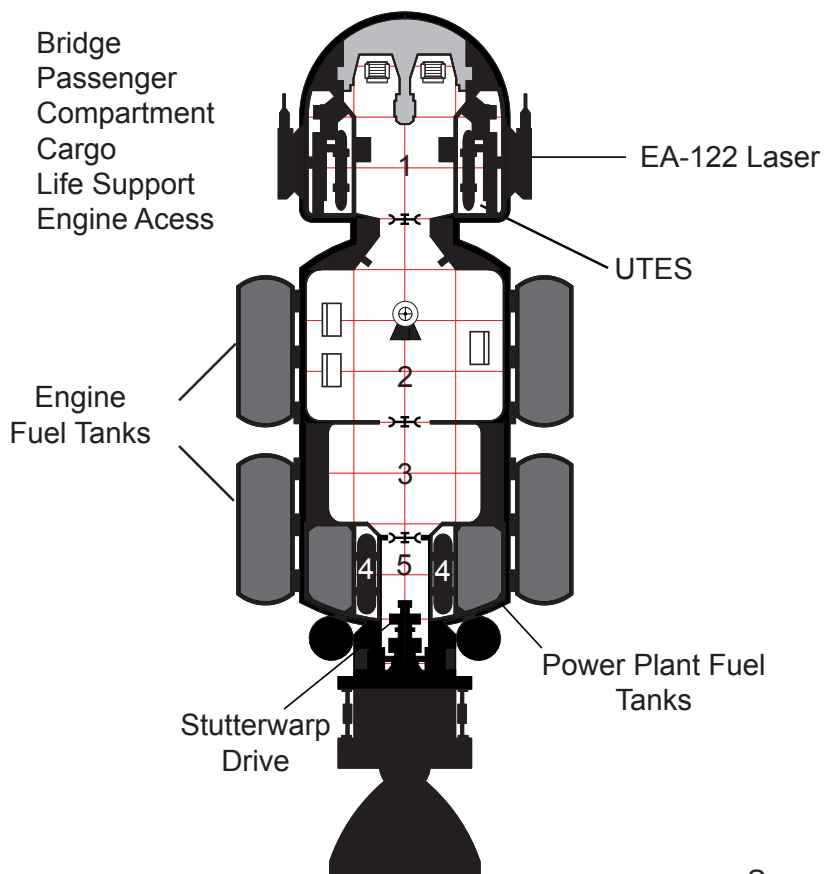

## OQC Cutter

## Lower Deck Level 2

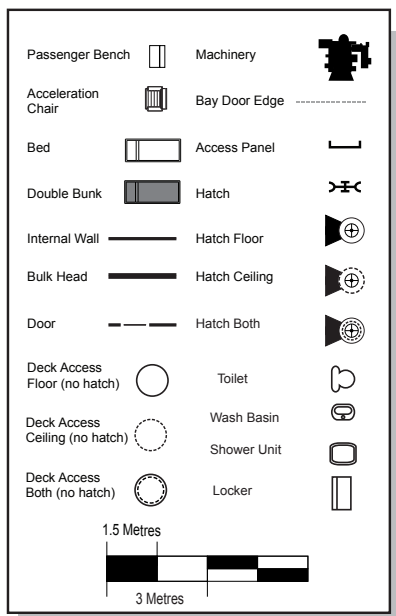
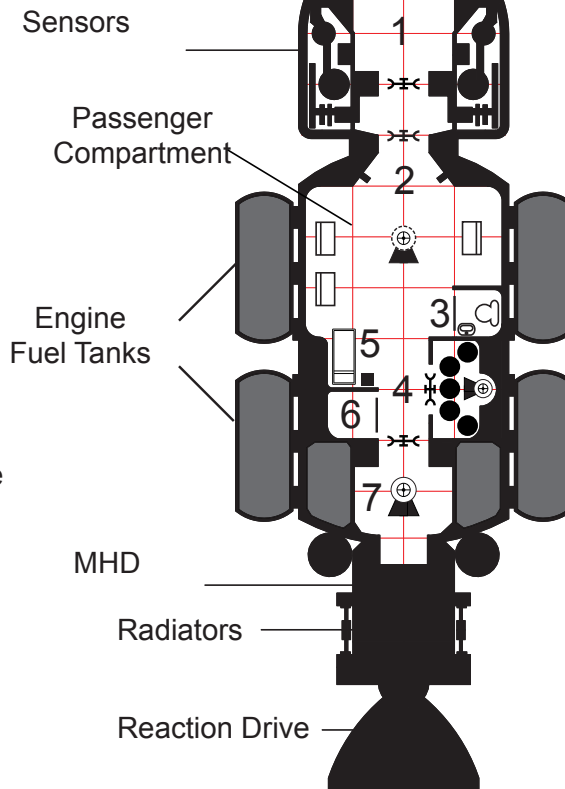

1. Breaching Tube
2. Passenger Compartment
3. Head
4. Drone Bay
5. Autodoc
6. Storage Locker
7. Airlock

# FIGHTERS

Fighters are small warships with limited endurance, designed to bring their weapons to close range against the enemy. They are also useful for screening operations, protecting the fleet from other fighters and from missiles.

## Martel

The sturdy Martel is widely regarded as one of the best fighters in human hands. It is aggressively marketed as well and examples and variants can be found in the hands of France, Britain and Canada (as the Harrier), Texas (as the Longhorn) and Freihafen (as the Jaeger). Most of the variants revolve around the fighter's primary armament, the two submunition dispensers. The heavily armed and armoured Martel is often employed as a ship-killer and has racked up impressive kill ratios vs. capital ships. Against fighters it does not fare quite as well, as it lacks the raw speed of many other designs. Its high armour does stand it in good stead, however.

TL: 12

First Example Laid Down: 2285

Last Example Laid Down: In production

Number Produced: 300+

Producing Nation: France and others under license

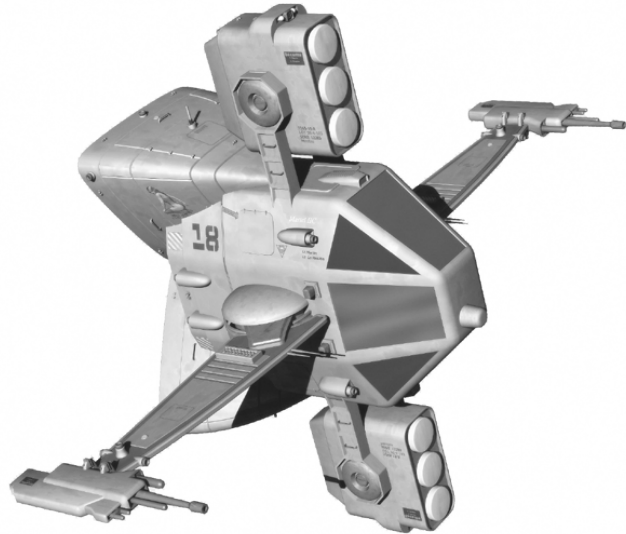

### Martel-class Fighter

| Hull                   |                        |           | Size (tons) | Cost (MLv)   |
|------------------------|------------------------|-----------|-------------|--------------|
| 40 ton hull            | Hull                   | 1         |             | 0.7          |
|                        | Structure              | 1         |             |              |
| Armour                 | 12                     | Composite | 4           | 0.7          |
| Stutterwarp Drive      | Unloaded               |           | 1.07        | 3.2          |
| New Military H         | Loaded                 | 3.6       |             |              |
|                        | Tactical               | 7         |             |              |
| Reaction Drive         | None                   |           |             |              |
| Power Plant            | MHD Turbine J          |           | 2.87        | 1.00         |
| Radiators              | Radiators J            |           | 0.3         | 0.15         |
| Cockpit                |                        |           | 3           | 0.20         |
| Computer               | Model 3                | Rating 15 |             | 0.16         |
| Software               | Stutterwarp/3          |           |             | 0.4          |
|                        | Library                |           |             |              |
|                        | Manoeuvre/0            |           |             |              |
| Electronics/Sensors    | Advanced               |           | 3           | 2            |
| Fuel                   | Power Plant            | 12 hours  | 3.36        |              |
|                        |                        | Aspects   |             |              |
| Weapon Mount 1         | Fixed Mount            | 1         | 0.1         | 0.5          |
|                        | EA-122 Laser           |           | 1           | 1.75         |
| Fire Control           | UTES                   |           | 1           | 0.6          |
| Weapon Mount 2         | Fixed Mount            | 1         | 0.1         | 0.5          |
|                        | EA-122 Laser           |           | 1           | 1.75         |
| Fire Control           | UTES                   |           | 1           | 0.6          |
| Weapon Mount 3         | Grape-Shot Submunition | All       | 6           | 2.5          |
| Weapon Mount 4         | Grape-Shot Submunition | All       | 6           | 2.5          |
| Missile Pack           | 3 Ritage-2 Missile     |           | 6           | 2.5          |
| Spin Habitat           | None                   |           |             |              |
| Comfort                | 0                      |           |             |              |
| Maintenance Cost       |                        |           |             | Lv1400/month |
| Life Support Cost      |                        |           |             | Lv2000/month |
| Total Tonnage and Cost |                        |           | 40          | MLv21.675    |

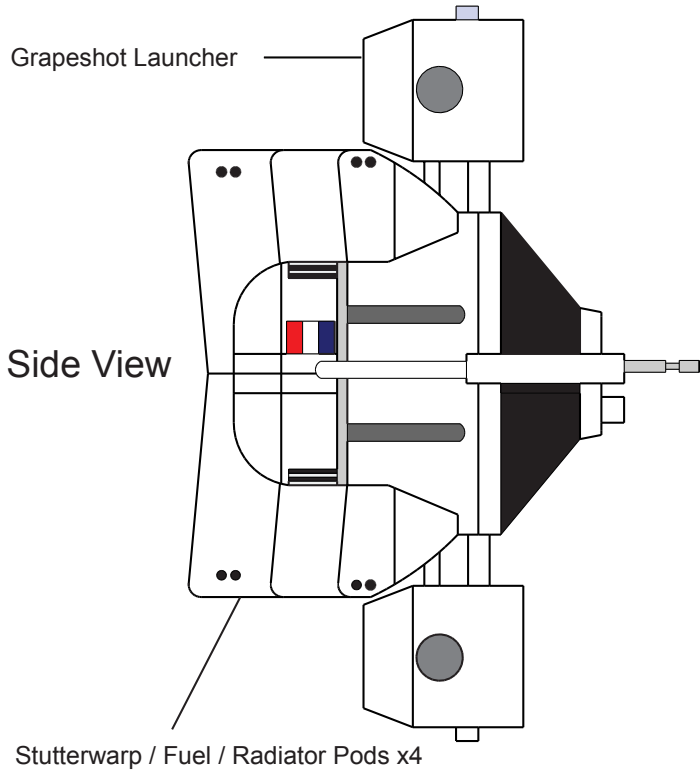

# Martel Fighter

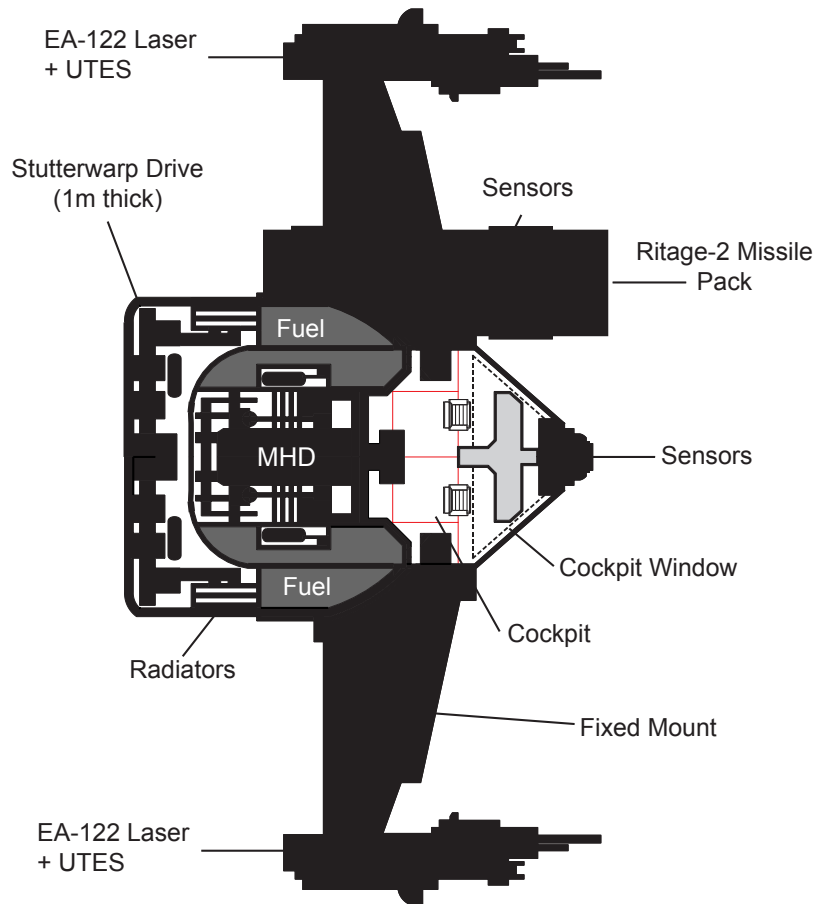
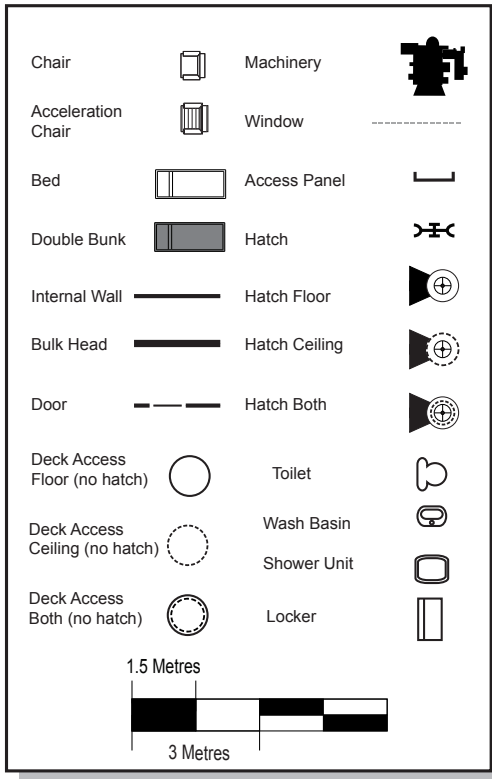

# WARSHIPS

## ACONIT-CLASS FRIGATE

The Aconit-class warship is probably the most commonly encountered military design in colonial space. It is a general-purpose warship that can operate from any frontier colony or outpost. It is not a fast ship, nor is it regarded as a well-armed or armoured vessel. Rather, its strength lies primarily in its basic, flexible and relatively inexpensive design.

The ship has an operating endurance of two weeks, after which it must refuel. This is enough to allow the ship to travel between any two star systems within the 7.7 light year limit. But as with the bulk of MHD powered vessels, the two-week endurance limits the ship to patrol or combat duty among populated systems where refuelling facilities are available or within tanker-equipped battle groups.

One aspect that makes the vessel particularly flexible is its interface capability. The ship's streamlining and thrusters allow the

Aconit to land itself on a world's surface, alleviating the need for carrying landers or relying on local facilities for getting personnel and equipment to and from a planet's surface. While a full-length landing strip is strongly recommended, the vessel's use of vertical thrusters allows the ship to set down on short runways and on planets with .6G or less gravity, it can set down vertically.

|             |    |
|-------------|----|
| Crew        |    |
| Bridge      | 15 |
| Engineering | 3  |
| Gunners     | 4  |
| Missiles    | 2  |

TL: 11

First Example Laid Down: 2243

Last Example Laid Down: 2291

Number Produced: 156

Producing Nation: France and others under license

### Aconit-class Frigate

| Hull                   |                 |           | Size (tons) | Cost (MLv)   |
|------------------------|-----------------|-----------|-------------|--------------|
| 400 ton hull           | Hull            | 8         |             | 8            |
|                        | Structure       | 8         |             |              |
| Streamlining           | Lifting Body    |           | 8           | 8            |
|                        | VTOL            |           | 40          | 8            |
| Landing Roll           | 0               |           |             |              |
| Take-off Roll          | 0               |           |             |              |
| Armour                 | 4               | Synthetic | 20          | 8            |
| Heat Shield            |                 |           | 0.70        | 0.4          |
| Stutterwarp Drive      | Unloaded        | 1.80      |             | 2.1          |
| Old Military K         | Loaded          | 1.60      | 1.1         | 3.29         |
|                        | Tactical        | 3         |             |              |
| Reaction Drive         | Thruster B      | 1 G       | 3           | 8            |
| Power Plant            | MHD Turbine K   |           | 4.76        | 1.0          |
| Radiators              | Radiators K     |           | 0.5         | 0.035        |
| Bridge                 |                 |           | 20          | 2            |
| Computer               | Model 2         | Rating 10 |             | 0.16         |
| Software               | Stutterwarp/B   |           |             | 0.2          |
|                        | Library         |           |             |              |
|                        | Manoeuvre/0     |           |             |              |
| Electronics/Sensors    | Advanced        |           | 3           | 2            |
| Fuel                   | Thruster        | 8 hours   | 80          |              |
|                        | Power Plant     | 2 weeks   | 117.6       |              |
| Cargo                  |                 |           | 22          |              |
| Staterooms             | 16              |           | 64          | 1.6          |
| Other Fixtures         | Autodoc         |           | 0.5         | 1            |
|                        |                 | Aspects   |             |              |
| Weapon Mount 1         | Standard Turret | 1,2,3,5   | 1           | 0.5          |
|                        | 2 EA-122 Laser  |           |             | 3.25         |
| Fire Control           | TTA             |           | 5           | 0.5          |
| Weapon Mount 2         | Standard Turret | 1,2,5,6   | 1           | 0.5          |
|                        | 2 EA-122 Laser  |           |             | 3.25         |
| Fire Control           | TTA             |           | 5           | 0.5          |
| Missile Bay            | 2 Ritage 2      |           | 2.2         |              |
| Missile Controllers    | 2 controller    |           | 0.5         | 1.0          |
| Spin Habitat           | None            |           |             |              |
| Comfort                | -1              |           |             |              |
| Maintenance Cost       |                 |           |             | Lv1400/month |
| Life Support Cost      |                 |           |             | Lv2000/month |
| Total Tonnage and Cost |                 |           | 400         | MLv63.28     |

# Aconit Class Frigate

## Level 1

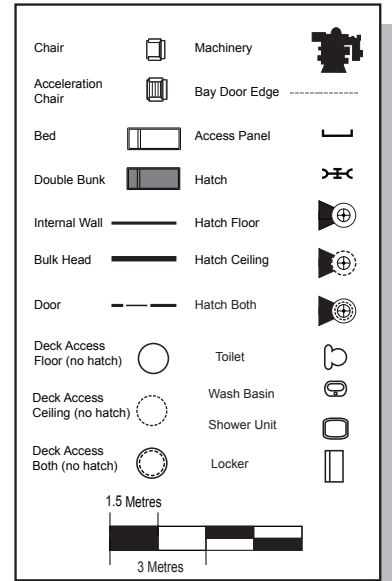

1. Bridge
2. TAC
3. Crew Lounge
4. Ward/Utility Room
5. Head
6. Captain's Quarters
7. Crew Quarters
8. Engineering
9. Maintenance Area
10. Upper Airlock / Escape Hatch

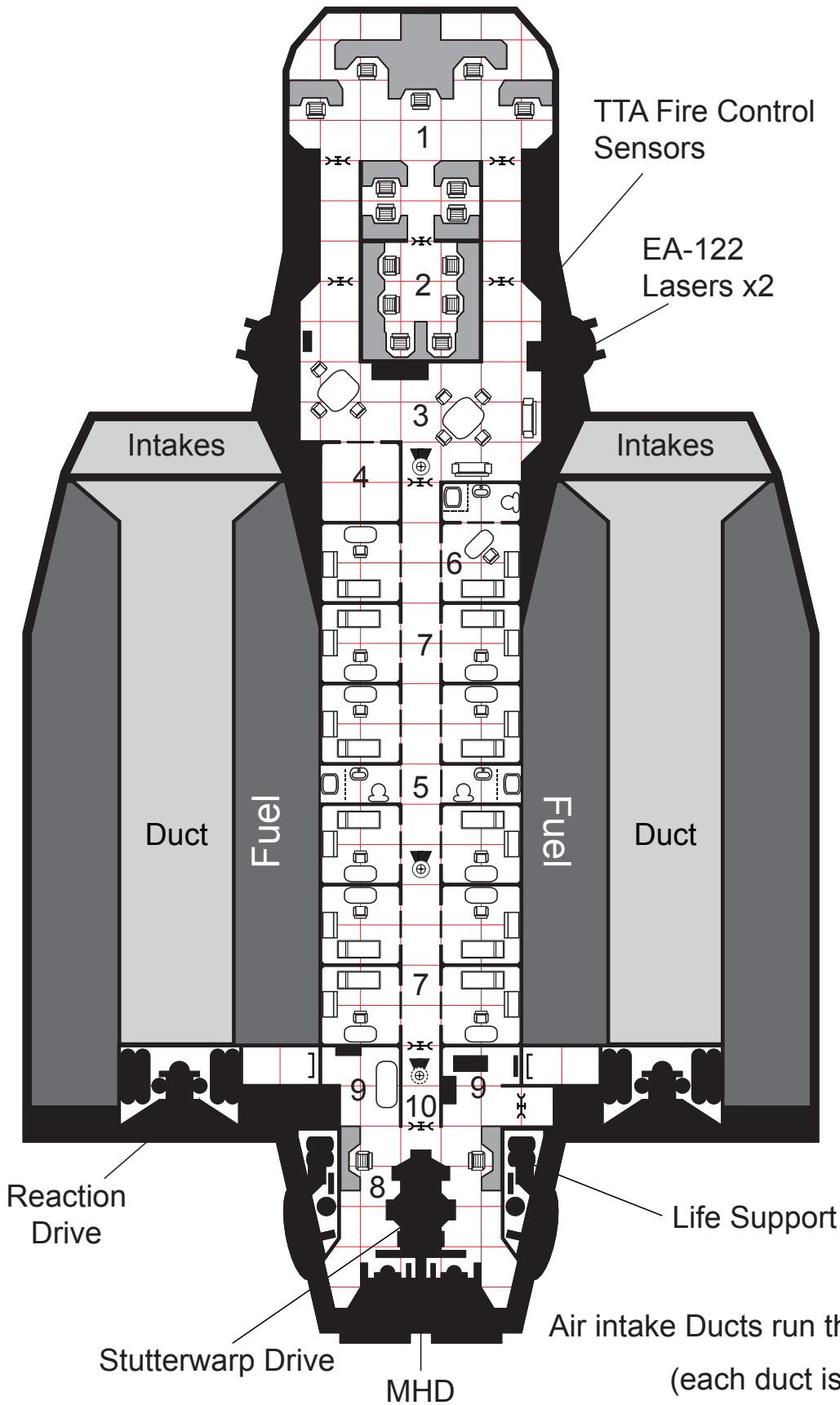



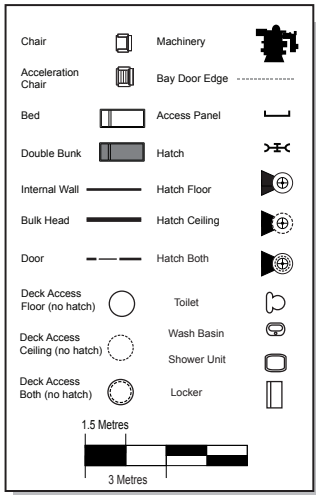
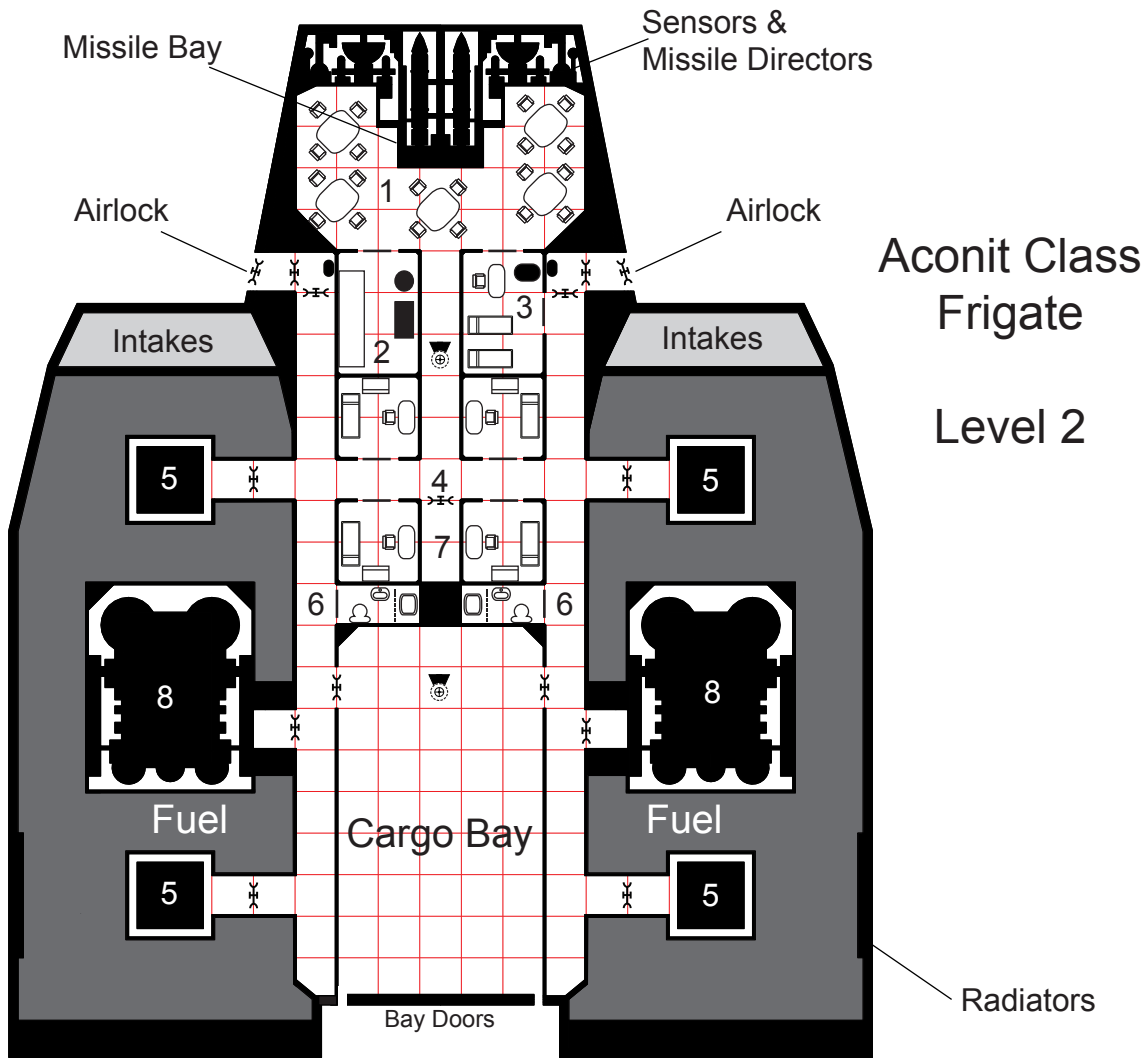

Fuel Tanks on Level 2 are 3.5m High

1. Crew Mess Room
2. Galley
3. Med Bay
4. Crew Staterooms
5. Landing Gear
6. Head
7. Storage
8. VTOL Engines

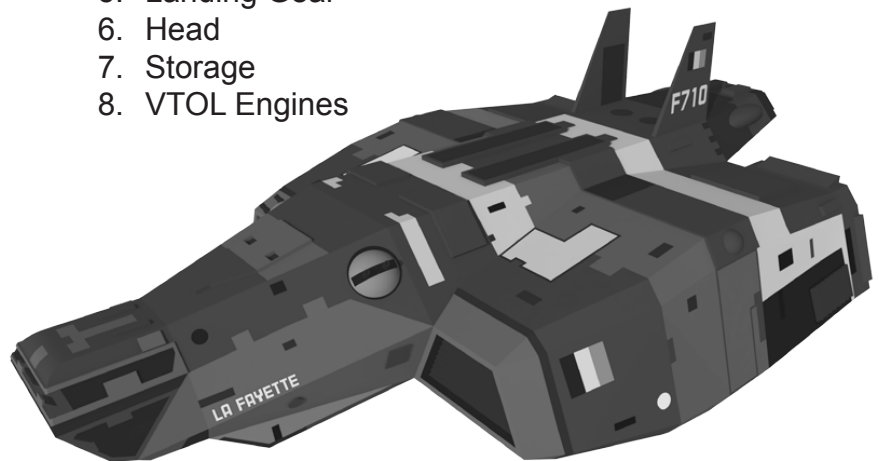

## JOHN F. KENNEDY-CLASS FAST MISSILE CRUISER

The American philosophy in warship design is 'Get in fast, strike hard, get out fast', which has led to the development of the Kennedy-class fast missile cruiser and her big sister, the Columbia-class battleship. Both vessels are heavy on their missile complement but to achieve the high speed the vessel is known for, the Kennedy-class has to accept some trade-offs, most notably in her lack of armour, screens and substantial gun armament. This latest refit adds a dedicated point defence system to the vessel's weapons mix, at the expense of two of her conven-

tional laser turrets. Kennedys run at a power deficit, meaning that the guns and the point defence systems cannot all fire at the same time, unless power is routed from the stutterwarp drive to the weapons.

### Names of Kennedy-class Cruisers

USS John F. Kennedy, USS Thomas Jefferson, USS Ronald Reagan, USS Jane Kostek, USS Abraham Lincoln, USS Colin Powell, USS Gordon Miller, USS George Washington, USS Jennifer Marlowe, USS Ernest White, USS Foxx Travis, USS Julia Pemberton, USS Calvin Morrison (Lost 2298)

### John F. Kennedy-class Fast Missile Cruiser

| Hull                |                            |           | Size (tons) | Cost (MLv) |
|---------------------|----------------------------|-----------|-------------|------------|
| 900-ton hull        | Hull                       | 18        |             | 45         |
|                     | Structure                  | 18        |             |            |
|                     | Stealth                    |           |             | 90         |
|                     | Self-Sealing               |           |             | 9          |
|                     | Radiation                  |           |             | 90         |
| Armour              | 0                          |           |             |            |
| Heat Shield         |                            |           |             | 0          |
| Stutterwarp Drive   | Unloaded                   |           | 6.12        | 18.35      |
| New Military U      | Loaded                     | 4.6       |             | 3.29       |
|                     | Tactical                   | 9         |             |            |
| Reaction Drive      | None                       |           |             |            |
| Power Plant         | Fusion U                   |           | 350         | 80         |
| Radiators           | Radiators U                |           | 35          | 0.175      |
| Bridge              | Holographic                |           | 20          | 5          |
| Computer            | Model 4                    | Rating 20 |             | 0.5        |
| Software            | Stutterwarp/D              |           |             | 0.4        |
|                     | Library                    |           |             |            |
|                     | Manoeuvre/0                |           |             |            |
| Electronics/Sensors | Advanced                   |           | 3           | 2          |
|                     | Military Countermeasures   |           | 20          | 15         |
|                     | Enhanced Signal Processing |           | 2           | 8          |
|                     | Grav Sensors               |           | 4           | 4          |
| Fuel                | N/A                        |           |             |            |
| Cargo               |                            |           | 37.8        |            |
| Staterooms          | 46                         |           | 184         | 4.6        |
| Other Fixtures      | Autodoc x10                |           | 5           | 10         |
|                     | Briefing Room              |           | 4           | 0.5        |
|                     | Recreation Facilities      |           | 10          |            |
|                     | Library                    |           | 4           |            |
|                     | 2 x 90 ton docking clamps  |           | 10          | 2          |
|                     | Armoury x 4                |           | 8           | 2          |
|                     | Repair Drones              |           | 10          | 2          |
|                     | HD-50 drones (2)           |           | 28.6        | 13.72      |
|                     | Probe Drones               |           | 1           | 5          |
|                     | Missile Workshop           |           | 8           | 1.2        |
|                     |                            | Aspects   |             |            |

|                        |                          |         |     |               |
|------------------------|--------------------------|---------|-----|---------------|
| Weapon Mount 1         | Standard Turret          | 1,2,3,6 | 1   | 0.5           |
|                        | 1 EA-122 Laser           |         |     | 1.75          |
| Fire Control           | UTES                     |         | 1   | 0.6           |
| Weapon Mount 2         | Standard Turret          | 1,2,5,6 | 1   | 0.5           |
|                        | 1 EA-122 Laser           |         |     | 1.75          |
| Fire Control           | UTES                     |         | 1   | 0.6           |
| Weapon Mount 3         | Standard Turret          | 1,2,3,4 | 1   | 0.5           |
|                        | 1 EA-122 Laser           |         |     | 1.75          |
| Fire Control           | UTES                     |         | 1   | 0.6           |
| Weapon Mount 4         | Standard Turret          | 1,4,5,6 | 1   | 0.5           |
|                        | 1 EA-122 Laser           |         |     | 1.75          |
| Fire Control           | UTES                     |         | 1   | 0.6           |
| Weapon Mount 5         | Standard Turret          | 1,2,3,4 | 1   | 0.5           |
|                        | 1 EA-122 Laser           |         |     | 1.75          |
| Fire Control           | UTES                     |         | 1   | 0.6           |
| Weapon Mount 6         | Standard Turret          | 1,4,5,6 | 1   | 0.5           |
|                        | 1 EA-122 Laser           |         |     | 1.75          |
| Fire Control           | UTES                     |         | 1   | 0.6           |
| Weapon Mount 7         | Standard Turret          | 1,2,3,4 | 1   | 0.5           |
|                        | PDC 17                   |         |     | 5             |
| Weapon Mount 8         | Standard Turret          | 1,4,5,6 | 1   | 0.5           |
|                        | PDC-17                   |         |     | 5             |
| Missile Bay            | 20 SIM-14                |         | 44  | 0.044         |
| Missile Controllers    | 6 controllers            |         | 1.5 | 1.0           |
| Spin Habitat           | Extendable Spin Capsules |         | 90  | 4.366         |
| Comfort                | -1                       |         |     |               |
| Maintenance Cost       |                          |         |     | Lv1,400/month |
| Life Support Cost      |                          |         |     | Lv2,000/month |
| Total Tonnage and Cost |                          |         | 900 | MLv453.751    |

|             |    |
|-------------|----|
| Crew        |    |
| Bridge      | 15 |
| Engineering | 15 |
| Gunners     | 20 |
| Missiles    | 12 |
| Stewards    | 4  |
| Troops      | 27 |
| Facilities  | 2  |

TL: 12  
 First Example Laid Down: 2285  
 Last Example Laid Down: 2316  
 Number Produced: 18  
 Producing Nation: America



# Kennedy Class Fast Missile Cruiser

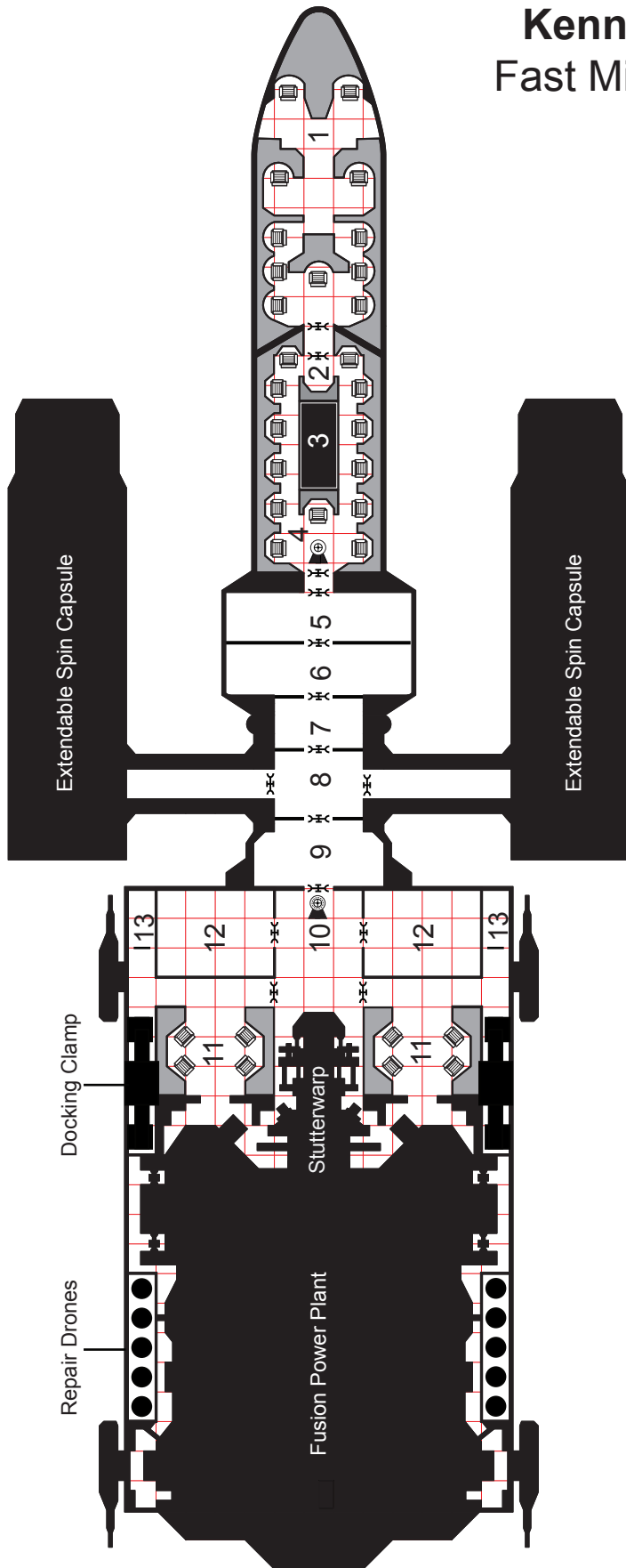

## Main Deck & Engineering Deck 1

1. Bridge
2. TAC
3. TAC Holo Table
4. Electronics Bay Access
5. B1 Deck
6. B2 Deck
7. Cargo/Life Support Deck 1
8. Spin Machinery/ Access Deck
9. Cargo/Life Support Deck 2
10. Maintenance Area
11. Engineering Station
12. Cargo Bay
13. Storage & Emergency Locker

Turret access thru underdeck crawlspaces and maintenance panels.



# Kennedy Class Fast Missile Cruiser

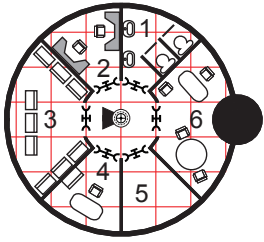

Deck B2

1. Head
2. Library
3. Armoury
4. Captains Office
5. Storage
6. Rest Room

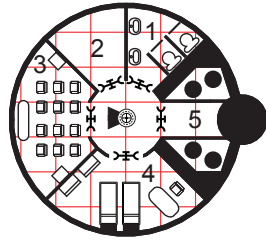

Deck B1

1. Head
2. Utility Room
3. Briefing Room
4. Med Bay
5. Probe Bay

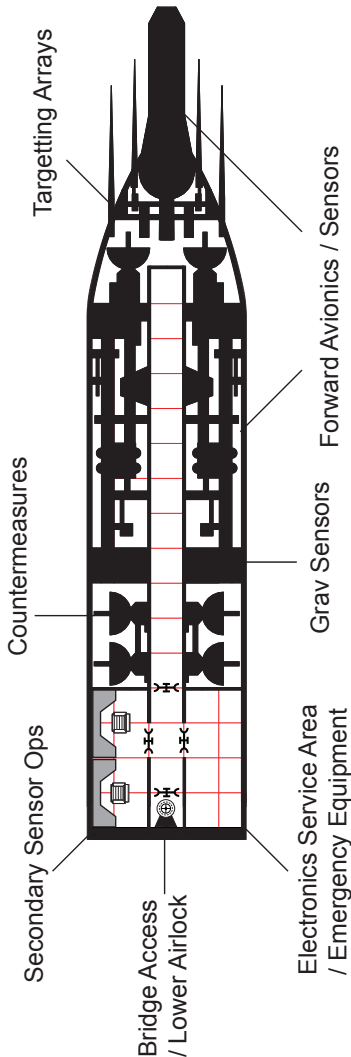
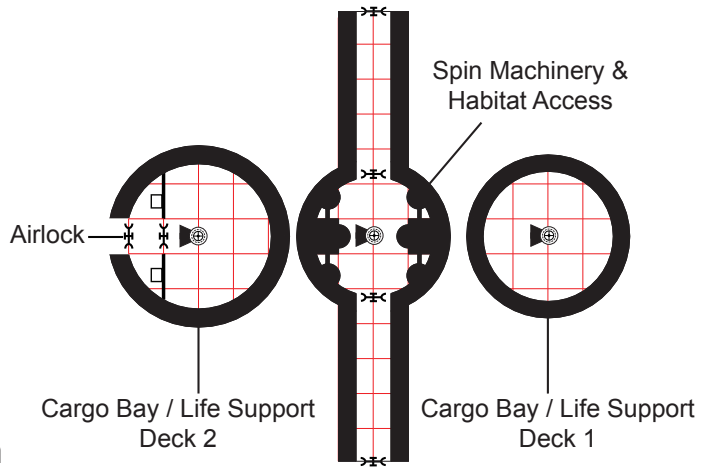

Electronics Deck  
(Underneath Bridge Deck)

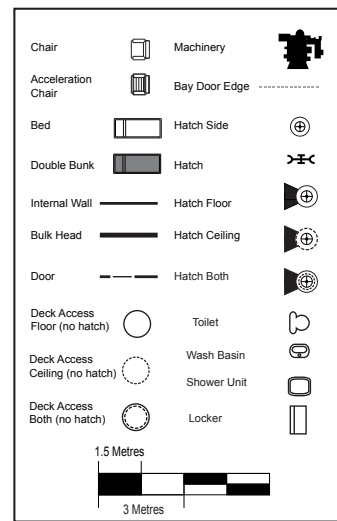

# Kennedy Class Fast Missile Cruiser

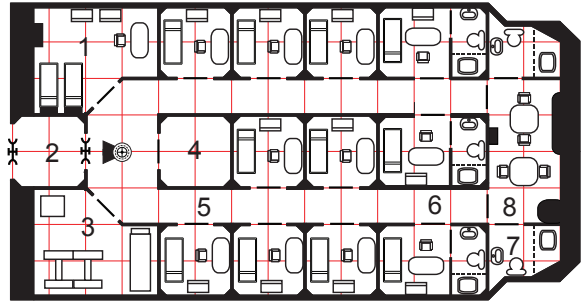
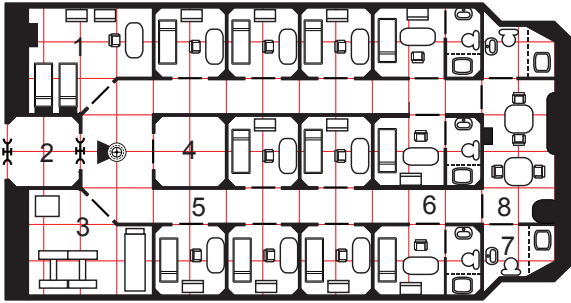

Spin Capsule Decks 1 & 2

Spin Capsule Decks 3 & 4

1. Medbay
2. Air Lock
3. Gym
4. Utility Room
5. Crew Staterooms
6. Officer's Staterooms
7. Head
8. Ward Room
9. Pantry
10. Galley
11. Mess Room
12. Lounge
13. Storage Locker

1. Medbay
2. Air Lock
3. Gym
4. Utility Room
5. Crew Staterooms
6. Officer's Staterooms
7. Head
8. Ward Room
9. Pantry
10. Galley
11. Mess Room
12. Lounge
13. Storage Locker

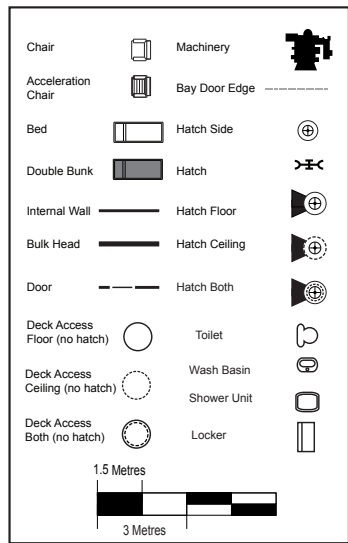

# Kennedy Class Fast Missile Cruiser

SIM-14 Missile Bay  
(lower section)

Power Plant / Missile Bay  
Lower Deck 2

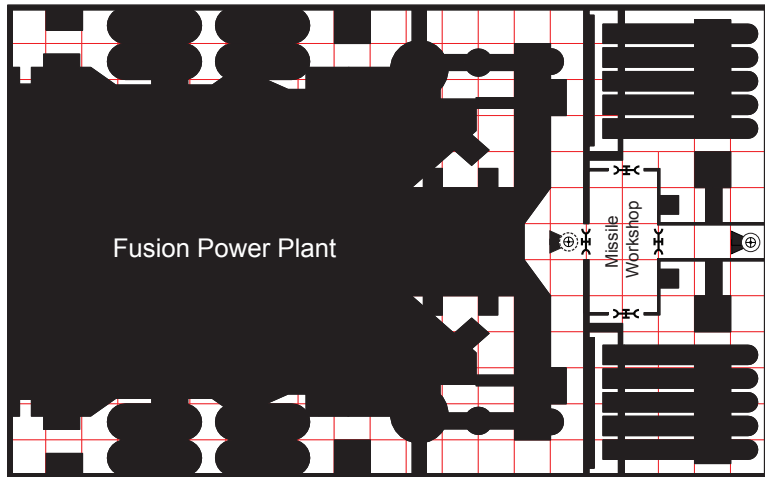

Power Plant / Drone Deck  
Lower Deck 1

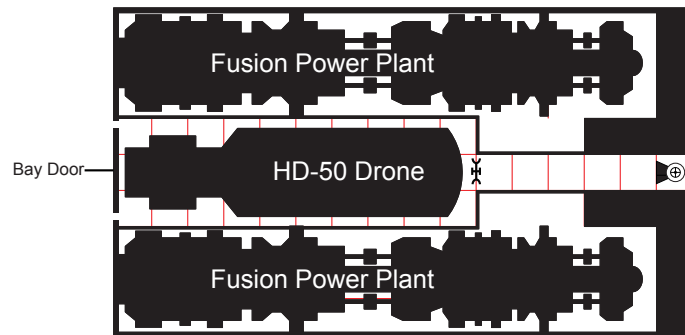

Lower Radiator 'Fin'

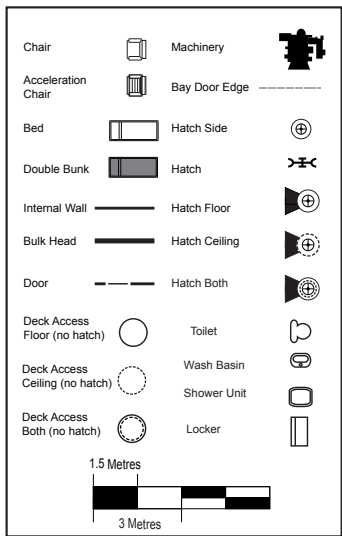

Fusion Plant Extends Through 6 Decks

# Kennedy Class Fast Missile Cruiser

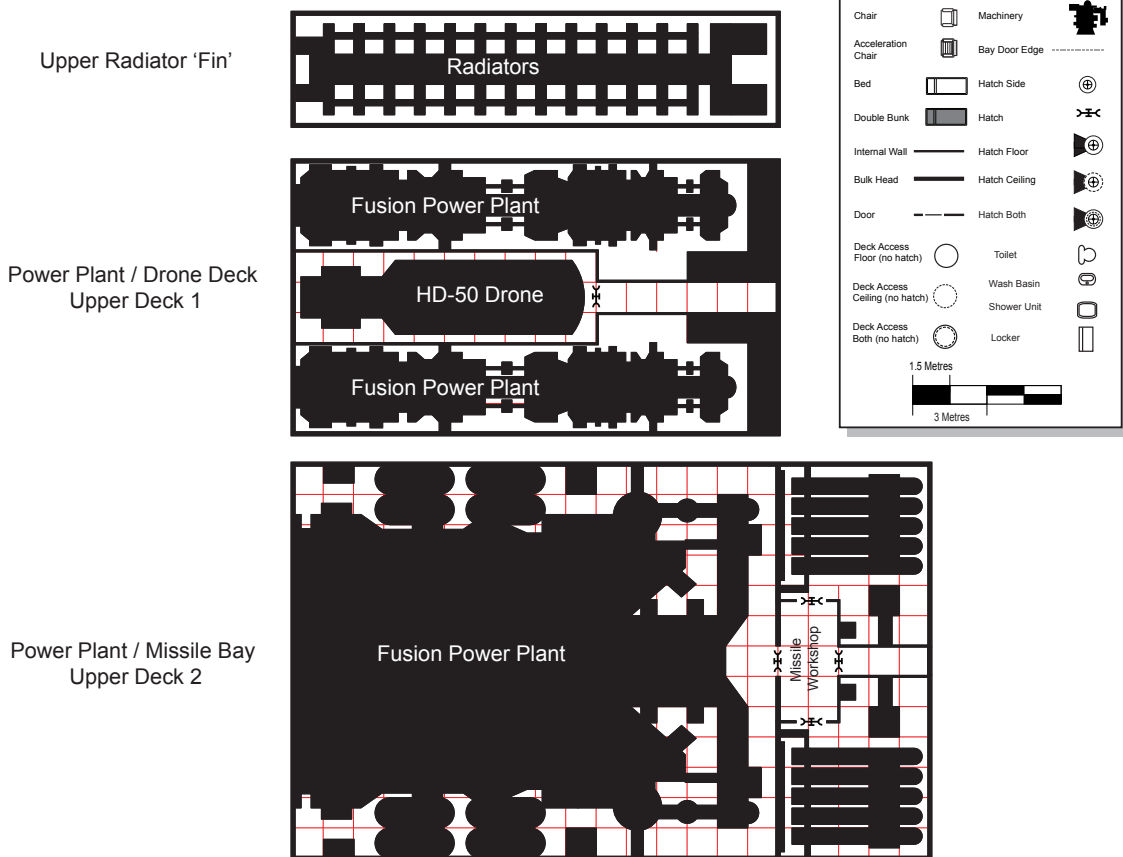

SIM-14 Missile Bay  
(Upper section)

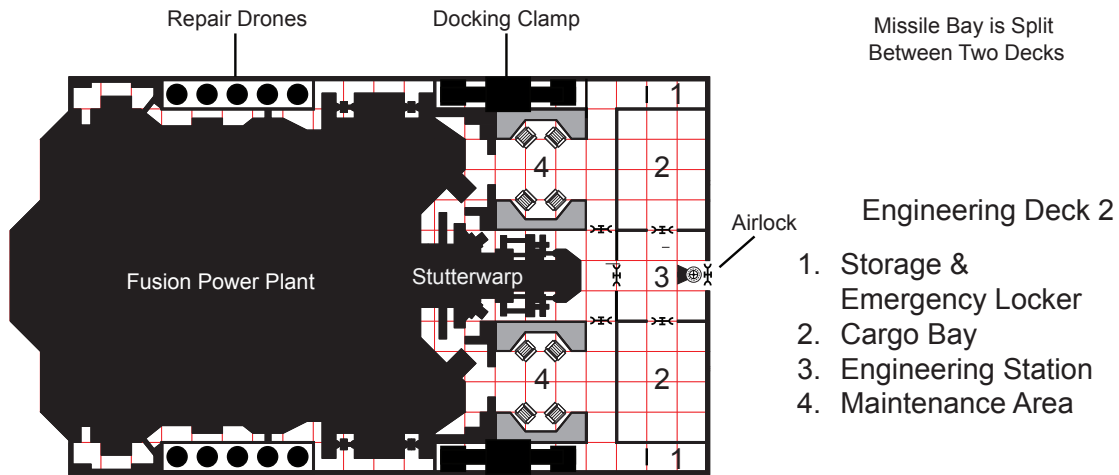

Fusion Plant Extends Through 6 Decks



# SPACE STATIONS

There are almost as many types of space stations as there are worlds that they orbit. They fall into two general types, however. The first is the modular station, quite common as the orbital terminal for new colonies or serving as small workshacks or research stations. These stations are made up of a number of small 30 ton modules connected together with integral connectors.

## MODULAR SPACE STATION

Modular Space Stations are common over all Human space. New colonies use them as orbital terminals, while more established worlds use them as laboratories, quarantine facilities or micro-factories.

The three modules presented here are the most common types, with others largely being variations on them. For example, a lab module is identical to the operations module, save that it replaces the workshop with another laboratory; while a quarantine module is identical to a living module, save that the doors cannot be opened from the inside.

Modular stations typically use a modified habitation module as a storm shelter. Each module does not have a storm shelter built-in.

## OPERATIONS MODULE

The operations module has a power deficit which must be met by an external power source. The command pod is for use during emergencies, docking manoeuvres and similar situations.

| Hull                | Operations Module       |         | Size (tons) | Cost (MLv)     |
|---------------------|-------------------------|---------|-------------|----------------|
| 30 ton hull         | Hull                    | 1       |             | 0.45           |
|                     | Structure               | 1       |             |                |
| Radiation Shielding | +6 armour vs. Radiation |         |             | 3              |
| Streamlining        | Standard                |         |             |                |
| Power Plant         | N/A                     |         |             |                |
| Radiators           | N/A                     |         |             |                |
| Cockpit             | 1 Man                   |         | 1.5         | 0.25           |
| Computer            | Model 3                 |         |             | 0.15           |
| Electronics/Sensors | Basic Civilian          |         | 1           | 0.3            |
| Fuel                | N/A                     |         |             |                |
| Cargo               | Supplies                |         | 3.5         |                |
| Staterooms          | 4                       | Offices | 16          | 0.4            |
| Other Fixtures      | Workshop                | 1       | 8           | 4              |
| Maintenance Cost    |                         |         |             | Lv2,000/month  |
| Life Support Cost   |                         |         |             | Lv24,000/month |
| Total Tonn          |                         |         |             | MLv8.55        |

## HABITATION MODULE

The habitation module requires an outside source of power.

| Hull                | Habitation Module       |   | Size (tons) | Cost (MLv)     |
|---------------------|-------------------------|---|-------------|----------------|
| 30 ton hull         | Hull                    | 1 |             | 0.45           |
|                     | Structure               | 1 |             |                |
| Radiation Shielding | +6 armour vs. Radiation |   |             | 3              |
| Streamlining        | Standard                |   |             |                |
| Power Plant         | N/A                     |   |             |                |
| Radiators           | Radiators A             |   | 0.3         | 0.03           |
| Cockpit             | N/A                     |   |             |                |
| Computer            | Model 3                 |   |             | 0.15           |
| Electronics/Sensors | None                    |   |             |                |
| Fuel                | N/A                     |   |             |                |
| Cargo               | Supplies                |   | 5.1         |                |
| Staterooms          | 6                       |   | 24          | 0.4            |
| Other Fixtures      | Recreation Space        |   | 0.6         | 0.3            |
| Maintenance Cost    |                         |   |             | Lv1,000/month  |
| Life Support Cost   |                         |   |             | Lv48,000/month |
| Totals              |                         |   | 30          | MLv4.33        |

## POWER MODULE

This solar power module supplies power for all other systems. It includes a fuel cell as a backup.

| Hull                | Power Module            |   | Size (tons) | Cost (MLv)    |
|---------------------|-------------------------|---|-------------|---------------|
| 30 ton hull         | Hull                    | 1 |             | 0.45          |
|                     | Structure               | 1 |             |               |
| Radiation Shielding | +6 armour vs. Radiation |   |             | 3             |
| Streamlining        | Standard                |   |             |               |
| Power Plant         | Fuel Cell A             |   | 1.19        | 5.0           |
| Radiators           | Radiators A             |   | 0.1         | 0.05          |
| Solar Panels        | Solar Panels A          |   | 0.5         | 0.05          |
| Cockpit             | 1 man                   |   | 1.5         | 0.25          |
| Computer            | Model 3                 |   |             | 0.15          |
| Electronics/Sensors | None                    |   |             |               |
| Fuel                | 4 weeks                 |   | 17.8        |               |
| Cargo               | None                    |   |             |               |
| Other Fixtures      | Workshop                |   | 8           | 4             |
| Maintenance Cost    |                         |   |             | Lv2,000/month |
| Life Support Cost   |                         |   |             | Lv8,000/month |
| Totals              |                         |   | 30          | MLv12.95      |

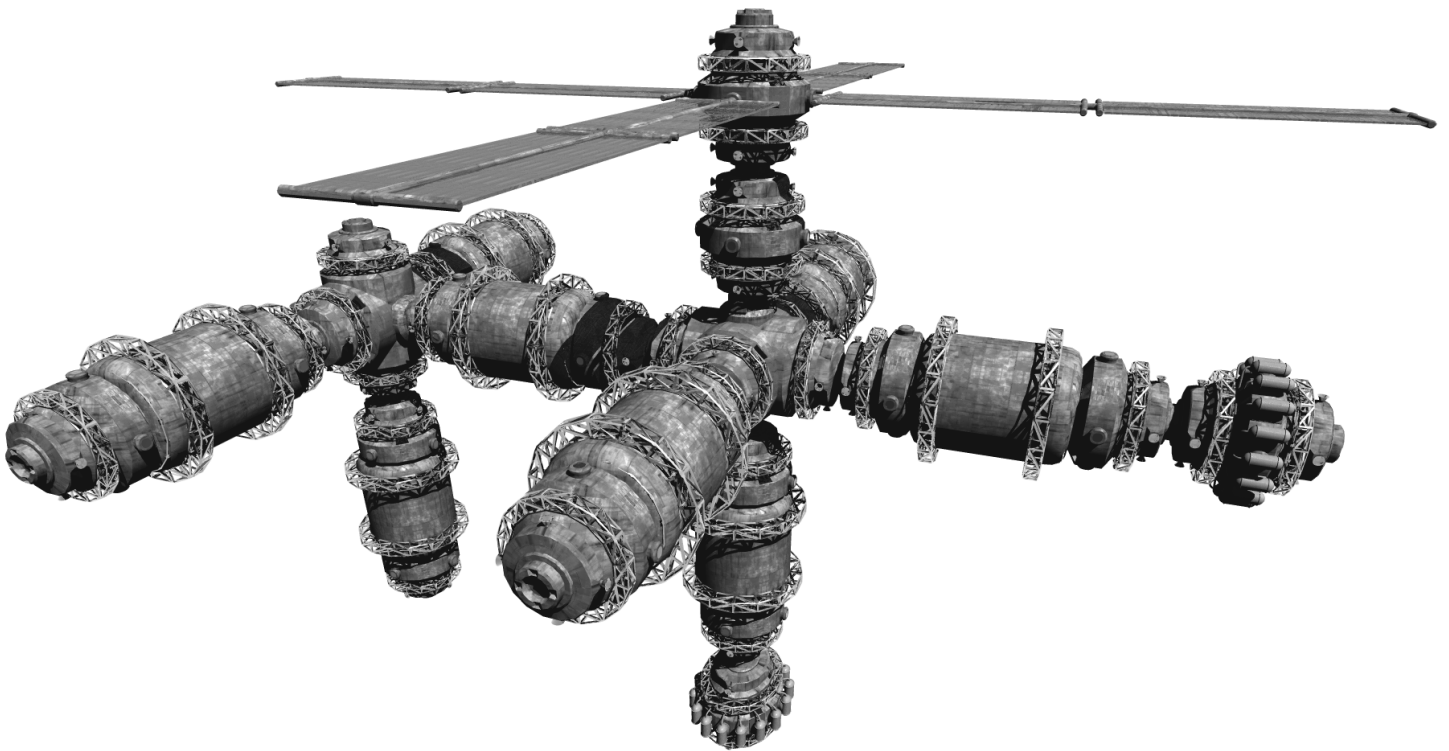

# Modular Station

## Operations Module

1. Control
2. Office
3. Life Support
4. Cargo
5. Head
6. Workshop
7. Sensor Bay

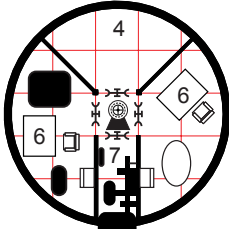
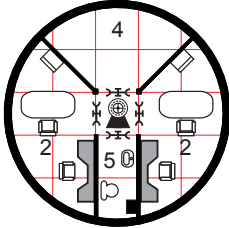
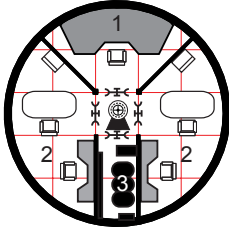

## Habitat Module

1. Cargo
2. Stateroom
3. Bathroom
4. Cargo & Life Support
5. Dining Area & Galley
6. Rest Area

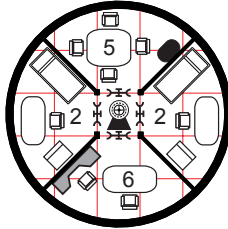
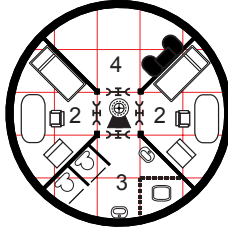
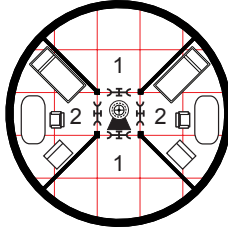

## Power Module

1. Control
2. Workshop
3. Power Cells & Life Support
4. Solar Panel Mounts

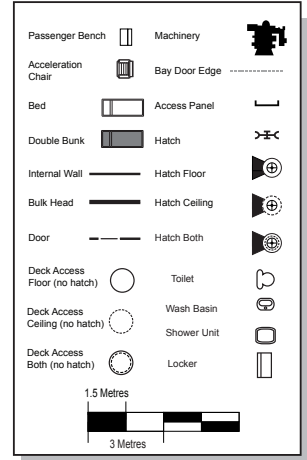
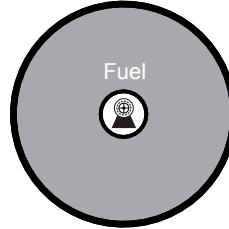
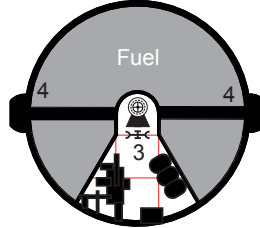
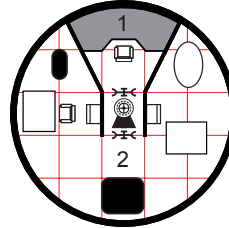

Standard Airlock / Docking Module

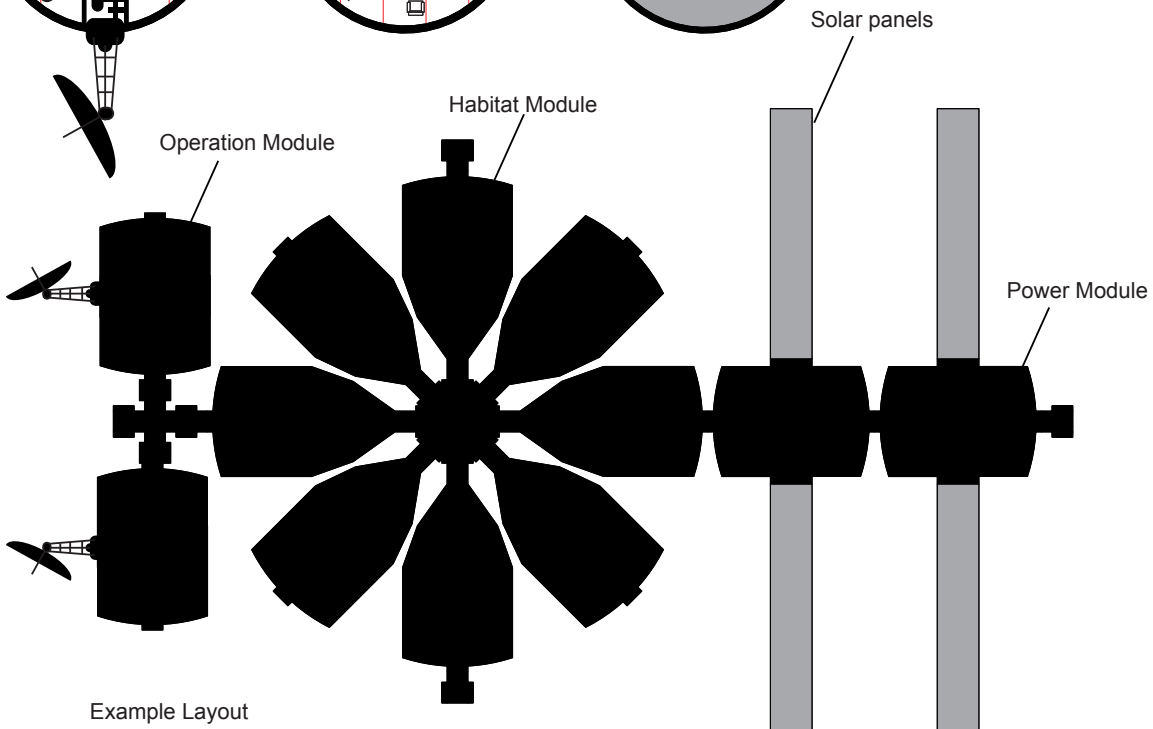
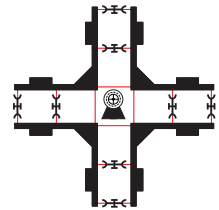

Example Layout

# SPACE TRAVEL AND SPACE COMBAT

The society of 2300AD is highly technical and highly mobile and the ultimate expression of both these traits is space travel.

Spacecraft and starships are extremely complicated pieces of engineering, yet at the same time they are quite commonplace in the 24th Century. Estimates run as high as 20,000 ships engaged in commercial operations throughout Human space, although the majority of those are spaceplanes, shuttles and other small craft. There are a number of tasks and operations associated with spacecraft, which will be looked into further in this chapter.

## INTERFACE TRAVEL

Interface travel is the process of getting to and from orbit and is one of the most expensive parts of space travel in 2300. On Earth and the colony world of Beta Canum Venaticorum, there are beanstalks orbital elevators that greatly reduce the costs associated with getting to and from orbit. However, these elevators often have long waiting times and the time to orbit via these constructs can be upwards of five days. Other methods include spaceplanes, SSTO vehicles, rockets and catapults, all of which are discussed in the following sections.

## BEANSTALK OPERATIONS

The most advanced, most comfortable and cheapest method of getting into orbit is the space elevator or Beanstalk, as it is often known. It is also the slowest, taking about five days to reach

geosynchronous orbit. Beanstalk travel is accomplished via elevator cars that travel along the cable, pulling themselves along through a series of redundant linear-magnetic motors. The motors are replaced at the end of each journey to or from orbit, whereupon they would have logged 35,000 kilometres.

Each passenger car is several decks high, with power at the bottom, followed by cargo, two decks of sleeper cabins, the dining lounge, then the recreation deck, then crew quarters and galley, then the observation lounge. Each car can carry 24 passengers in double cabins, plus 4 crew members. Cargo cars feature several decks of cargo and have no crew.

During the trip to orbit, the passengers will experience a fall-off in gravity. By the end of the first day of travel, gravity in the capsule is just 0.2 G but does not reach 0 G until the end of the fifth day, when the capsule reaches geosynchronous orbit.

Travel on a Beanstalk carriage is usually quite luxurious, with many of the carriages designed around a 19th Century rail car theme or some other period in history.

## SPACEPLANE OPERATIONS

The spaceplane provides a relatively luxurious flight to orbit. Smaller models are dedicated to passenger carriage, while many larger models are used exclusively for freight. In part because

Earth Beanstalk System

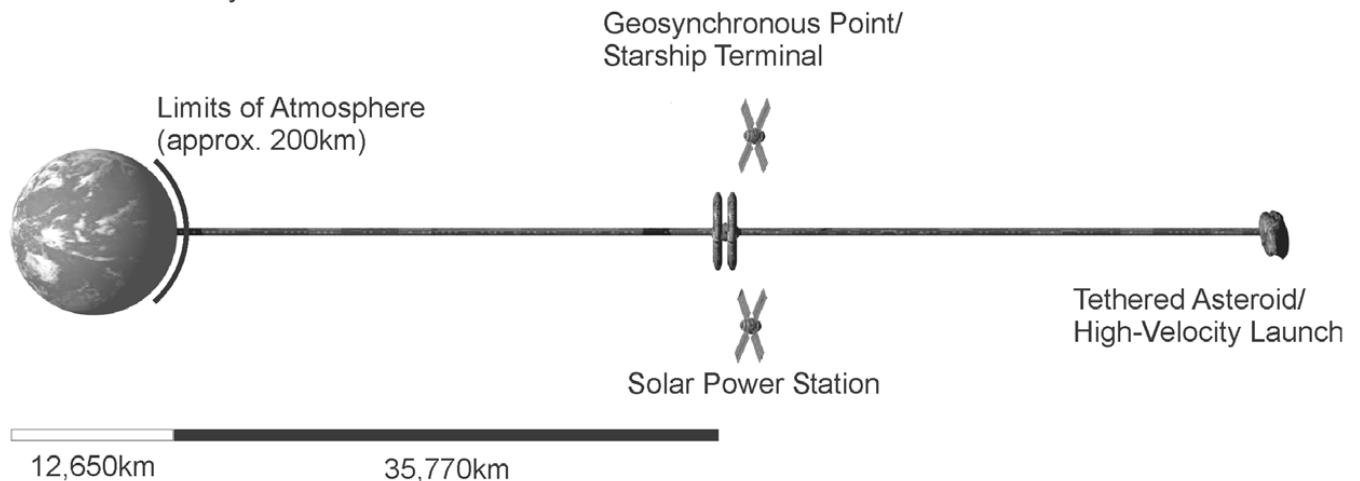

(Note: Objects are NOT to scale)

---

## Murder on the Gateway Express

On a trip up the Earth Beanstalk, one of the passengers is murdered and the PCs look like the prime suspects. Can they clear their name in the four days before the capsule reaches Gateway station?

---

of its ability to manoeuvre, the spaceplane is also the preferred method of interface travel for the military. Space planes use hybrid air-breathing rockets or scramjet/rocket combinations to achieve flight through the atmosphere and into orbit. On high gravity worlds or for heavy cargos, solid-fuel boosters are sometimes required. Spaceplanes are operated in a similar fashion to 20th Century airlines, although the trip durations are usually much shorter.

### Tasks Associated with Spaceplane Operations

Launch: Routine Astrogation

Flight: Routine Piloting

Orbital Insertion: Difficult Pilot

Skill Roll DMs: Planetary Gravity: Zero-gravity (0–0.4 G) +2, Low gravity (0.4–0.8 G) +1, Normal 0, High Gravity (1.25+) –1  
+1 per computer model number

### SSTO OPERATIONS

Far away from civilised airfields and runways, the SSTO can land in any clearing big enough for the wide aerofoil rotors used for take-off and landing, without the environmental damage of conventional drive systems. However, its lack of atmospheric manoeuvring ability restricts it to the civilian sector. Most SSTOs are not able to operate on high-gee worlds, as they are not designed to accept auxiliary boosters.

Launch: Routine; Astrogation + EDU

Flight: Routine; Pilot + DEX

Orbital Insertion: Average Pilot + DEX

Skill Roll Modifiers: Zero-gravity (0–0.4 G) +4, Low gravity (0.4–0.8 G) +2, Normal 0, High Gravity (1.25+) –2  
+1 per computer model number

### ROCKET OPERATIONS

Simple, reliable and cheap, basic rockets are used to provide disposable cargo lifting to orbit. Only rarely are they used for passengers. Rockets carry fairly large payloads for their size and cost but are not reusable.

Launch: Routine; Astrogation + EDU

Flight: Routine; Pilot + DEX

Orbital Insertion: Average Pilot + DEX

Skill Roll Modifiers: Zero-gravity (0–0.4 G) +4, Low gravity (0.4–0.8 G) +2, Normal 0, High Gravity (1.25+) –2  
+1 per computer model number

### Catapault OPERATIONS

The last method of orbital access is only suitable for inert cargo, as the heavy accelerations of the catapult render it unsuitable for live cargo. Catapult sleds are often launched with accelera-



---

### Time to Intercept

When a raider party comes in from out-system, planet-based fighters have to take into account the time it takes them to claw their way out of the gravity well. Reaction fighters are often deployed from orbit for just that reason and make the initial intercept while the rest of the fighters are forming up.

---

tions of 100 G or more. As they are powered by a ground-based system, the catapult is one of the most cost-effective forms of interface travel for durable goods. Flight time for a catapult sled is only a couple of minutes or even less.

Only one task roll is required of an operator to place a cargo in orbit:

Average Astrogation check: DM–2 for high gravity worlds, +1 for Low Gravity and +2 for Zero-gravity.

### TIME TO ORBIT

The time required for an interface vessel to reach low orbit is equal to world UWP Size Code divided by the 2 x Acceleration rating of the vehicle, in hours.

Earth is a size 8 world. A 2 G spaceplane taking off from Earth would require  $(8/(2 \times 2)) = 2$  hours.

Time to reach high orbit is double this amount.

Rockets and SSTO take only half the time of spaceplanes, while catapults only take 5–10 minutes on any world. On Earth, the rocket and SSTO would take one hour to reach low Earth orbit.

Worlds with no atmosphere use the times listed for SSTs and Rockets. Low orbit is usually between 120 and 300 kilometres in altitude, while high orbit is between 400 and 600 kilometres in altitude.

### REENTRY AND LANDING

Landing on a planet is typically a simpler proposition than getting off of it but there are some factors to keep in mind.

## **DEAD GLIDERS**

An unpowered landing can be made by an airframe vessel. The world has to have an atmosphere for this method. Many commercial spaceplanes use this method.

Re-entry: Difficult Astrogation + EDU

Flight: Average Pilot + DEX

Landing: Average: Pilot + DEX

Requires Vessel/Small Craft Proficiency and Pilot Skill

Modifiers: Zero-gravity (0–0.4 G) +4, Low gravity (0.4–0.8 G) +2,

Normal 0, High Gravity (1.25+) –2 Trace Atmosphere –2 Thin Atmosphere –1, Dense Atmosphere +1

+1 per computer model number.

## **POWERED LANDING (ATMOSPHERE)**

Spaceplanes often use powered landings and military landing craft use it extensively.

Re-entry: Difficult Astrogation + EDU

Flight: Pilot vs. DC 12

Landing: Pilot vs. DC 12

Requires Vessel/Small Craft Proficiency and Pilot Skill

Modifiers: Micro-gravity (0–0.4 G) +4, Low gravity (0.4–0.8 G) +2, Normal 0, High Gravity (1.25+) –2

Trace Atmosphere –2 Thin Atmosphere –1, Dense Atmosphere +1

+1 per computer model number.

## **POWERED LANDING (VACUUM)**

Used by landers on airless worlds.

Reentry (de-orbit): Formidable Astrogation + EDU

Flight: Difficult Pilot + DEX

Landing: Difficult Pilot + DEX

Modifiers: Micro-gravity (0–0.4 G) +4, Low gravity (0.4–0.8 G) +2, Normal 0, High Gravity (1.25+) –2

+1 per computer model number.

## **SSTO**

The SSTO is a combination of a ballistic drop coupled with a powered landing from its retractable aerofoils. On a vacuum world the SSTO uses the same series of tasks as any vessel making a powered landing in vacuum.

Re-entry: Difficult Astrogation + EDU

Flight: Average: Pilot + DEX

Landing: Routine: Pilot + DEX

Modifiers: Micro-gravity (0–0.4 G) +4, Low gravity (0.4–0.8 G) +2, Normal 0, High Gravity (1.25+) –2

Trace Atmosphere –2 Thin Atmosphere –1, Dense Atmosphere +1

+1 per computer model number.

## **BALLISTIC DROPS**

Ballistic drops use a method similar to the first manned space flights and just drop the re-entry vehicle into the atmosphere.

A simple ablative heat shield and parachutes slow the vehicle down enough for it to land. After the ballistic package re-enters an atmosphere it can no longer be controlled.

## **Lucky Cats**

Many merchant vessels carry a ship's cat. The Japanese will tell you this is because it has long been a tradition on Japanese vessels to carry a tortoiseshell cat for luck and how, at the end of the Twilight War, the Japanese had the world's only major merchant fleet. Other nations, the Japanese say, picked up on the idea and spacers being a superstitious lot, continued it themselves.

The tradition of a ship's cat, however (tortoiseshell or otherwise), was common on surface ships of all nations long before Twilight and it is inevitable (people being what they are) that the custom continued on space ships.

Re-entry: Difficult Astrogation + EDU

Flight: N/A

Landing: N/A

Modifiers: Micro-gravity (0–0.4 G) +4, Low gravity (0.4–0.8 G) +2, Normal 0, High Gravity (1.25+) –2

Trace Atmosphere –2 Thin Atmosphere –1, Dense Atmosphere +1

+1 per computer model number.

Note that any of these Skill checks can be made by a remote operator or computer program.

## **TRAVEL TIME**

Time from orbit is based on world size and atmosphere type, modified by whether the vehicle is a dead glider, a ballistic drop or a powered landing.

Even the powered vehicles generally glide for a good portion of their drop, largely to save fuel.

## **TRAVEL TIME, FROM ORBIT**

Glider: Travel Time = 10 x world UPP Size Code, in minutes

Ballistic Drop: Travel Time = 5 x world UWP Size code, in minutes

Powered Landing: Travel Time = 2 x world UWP Size code, in minutes

Powered Landing (vacuum world): Travel Time = world UWP Size code, in minutes

## **DAMAGE AND REENTRY**

Any vehicle that has taken more than two points of Hull damage will be unable to attempt atmospheric re-entry, as its heat shield will have been compromised. A skilled pilot may attempt to do so but the re-entry roll goes becomes Formidable. Failing this roll means that the vessel is destroyed on re-entry.

## **SYSTEM SHIPS**

Systems ships are slow, low-powered stutterwarp vessels designed for carrying cargo across interplanetary distances. Beyond the system's FTL shelf they can actually manage FTL

speeds, making transport beyond the shelf very fast. Transport in the rest of the system is relatively slow, although still more effective than reaction-drive vessels. These ships use very small and inexpensive stutterwarp drives, allowing even non-star-faring nations and organisations access to interplanetary space.

## ZERO-GRAVITY

Prolonged exposure to zero-gravity can have detrimental health effects. The 0G DNA modification largely alleviates these problems but they can still strike.

For every week in a zero-gravity environment, characters must make a Routine END check, with a cumulative -2 DM per week. If the Check fails, they suffer a cumulative -1 to both Str and Con due to muscle and bone degradation, with a maximum loss of -3. It will require two weeks of exercise per lost point to regain the character's correct stats.

The 0G DNA modification gives a +6 to all rolls to avoid stat loss.

ZG therapy gives a DM of +4 for these rolls. ZG therapy costs Lv200 per week.

## ARTIFICIAL GRAVITY/SPIN HABITATS

For any sort of long-duration flight, artificial gravity is necessary to maintain the health and well-being of the crew. The low gravities generated by spin habitats do contribute but still require stringent exercise and metabolic treatments. The psychological effects cannot be ignored; even minimal gravity allows the crew to eat, sleep and perform other daily functions in relative comfort and ease.

Many voyages between the stars can require weeks or even months, to reach their destinations, so some sort of artificial gravity is necessary. The only practical way to accomplish this in 2300 is through the use of spin habitats, which provide a sensation of gravity through centripetal force. Spin habitats do not eliminate the need for Checks for a reduction in stats. However, they do change the frequency of checks required and provide a DM to the check as well.

| Perceived Gravity | Check Frequency | DM to END Check |
|-------------------|-----------------|-----------------|
| None              | 2 weeks         | -3              |
| 0.01-0.10         | 4 weeks         | -2              |
| 0.11-0.50         | 8 weeks         | -1              |
| 0.51-0.75         | 12 weeks        | 0               |
| 0.76+             | 6 months        | +1              |

Spun Hull: This is the simplest but usually largest, spin habitat type available. The hull is simply a large cylinder that spins around its axis, providing gravity along the edge of the cylinder. Due to Coriolis effects, the central part of the cylinder (within a radius of six metres) is unusable for crew or passengers and is usually used for cargo, fuel and low maintenance machinery. More often the hull is built as a torus and the central core is occupied by a non-spinning drive/power plant module. Most large space stations are constructed in this fashion.

Double Hull: The outer hull spins but surrounds an enclosed inner hull that does not. The design is most useful for large designs, as the enclosed central hull is at least 10 metres in radius.

Hamster Cage: The hamster cage is a cylindrical module that is at least 15 metres in radius and spins to create an artificial gravity. Unlike other designs, the hamster cage is usually set at right angles to the hull and is usually installed in counter-rotating pairs. This eliminates torque effects on the ship's attitude.

Spin capsules: The spin capsule system is a set of small capsules at the end of a long rotating arm. Most ships have between one and four of these capsules, although two is the most common number.

Extendable spin capsules The extendable spin capsule can retract against a vessel's hull, minimising the target profile and reducing the vulnerability of the ship's life support sections in combat or while manoeuvring.

Two-body: Two ships of the same size can join up via a retractable tower or pylon and spin around the common centre of mass. This was common in older vessels.

All the different types of spin habitats have essentially the same effect. The perceived gravity inside the spin habitat depends on two factors: diameter of the habitat and speed of rotation. The larger the habitat, the slower it has to rotate to produce a certain felt gravity. The faster a spin habitat rotates, the higher the felt gravity for a certain radius.

| Radius | 4 RPM | 3 RPM | 2 RPM | 1 RPM | <1 RPM |
|--------|-------|-------|-------|-------|--------|
| 15m    | 0.26G | 0.15g | 0.07g | 0.02g | 0.01g  |
| 30m    | 0.53G | 0.30g | 0.13g | 0.03g | 0.02g  |
| 45m    | 0.81g | 0.45g | 0.20g | 0.05g | 0.03g  |
| 60m    | 1.0y  | 0.60g | 0.27g | 0.07g | 0.04g  |

High RPM values can have a negative effect on balance and can even induce nausea. Anything over 4 RPM is distinctly unhealthy, while 1-3 RPM can have negative side-effects. Civilian ships will rarely rotate at more than 1 RPM, while military ships may go up to 3 RPM.

Space Stations: Space stations are usually designed with a very large radius and usually spin at rates under 1 RPM. The large space habitats only spin at about 1/3 RPM. Many large stations feature several rings or habitat zones to provide lighter or heavier gravity than normal.

The following chart contains the normal RPM values found in most ships. The End Check is the roll that must be made to avoid nausea and dizziness. If the roll is failed, then the effects of the next column take effect. This roll is made each week.

| RPM | Endurance Check | Effect if failed |
|-----|-----------------|------------------|
| 3   | Difficult       | -3 Dex, -2 End   |
| 2   | Routine         | -2 Dex, -1 End   |
| 1   | Easy            | -1 Dex           |

## RADIATION

There are many different sources of radiation in space. Fission and fusion Power Plants produce significant amounts of radiation, as do nuclear weapons and particle beam weapons. Operating stutterwarps also produces radiation, although usually in small amounts. Additionally, all stars output large amounts of radiation and during flares and storms can put out lethal doses in a short amount of time. Any planet that has a magnetic field also possesses radiation belts, as the magnetic field captures energetic particles put out by the local star. Gas giants in particular often have extremely intense radiation belts.

### Sources of Radiation

| Source                       | Severity | Rads/hour |
|------------------------------|----------|-----------|
| Fission Power Plant Breach   | Severe   | 400       |
| Fusion Power Plant Breach    | Moderate | 180       |
| Operating stutterwarp        | N/A      | 2         |
| Solar Radiation              | Mild     | 50        |
| Solar Flare                  | Lethal   | 800–1,000 |
| Radiation Belt (Terrestrial) | Moderate | 200       |
| Radiation Belt (Gas Giant)   | Lethal   | 800–900   |

For protection from radiation, ships usually use a Lafarge radiation screen; an electromagnetic screen that blocks high energy charged particles. It is less effective against other types of radiation, although these can usually be blocked or at least attenuated by the hull. Nor is the radiation screen effective against particle beam weapons, as those weapons use neutral particles. However, the screen is somewhat effective against the secondary particles spalled off from a particle beam strike. (Reduce severity of radiation damage by one level, e.g. Severe to Moderate.)

## STUTTERWARP

The stutterwarp drive is one of the more complex technologies created by humanity and few profess to completely understand it. It enables faster-than-light travel, giving people access to the stars. It stands out as the only watershed theoretical breakthrough, which took place between the beginning of the global recovery from World War III and the present (2300 AD). This discovery was made in 2080 AD at the new large French synchrotron facility at Grenoble. On August 18th of that year, a complete hydrogen molecule was induced to perform a microscopic quantum jump. Within two years the experiment had been replicated at the C.E.R.N. facility in Switzerland and a small group of theoretical physicists had realised that mankind had finally discovered the key to the stars. However, scaling up the Jerome effect (Named for Dr. Emile Francois Jerome, 2021–2103) from moving a single hydrogen molecule to moving a large fabricated spacecraft was a long, complex and extremely expensive proposition. It was not until 2136 AD that the first unmanned stellar probe was launched and eight more years

passed before manned survey ships were launched to the stars. These early designs were quite slow compared to modern vessels but actually had the same range: 7.7 light years.

## THE BASICS

Stutterwarp drives operate on the same principles as the tunnelling phenomenon that can occasionally be observed in some sub-atomic particles. The tunnelling effect allows a physical mass to be moved from one location in space to another, instantaneously, without passing through the intervening space.

The distance that a stutterwarp vessel travels is relatively short and depends on local gravity conditions but in interstellar space each jump is typically several hundred metres. Stutterwarp drives cycle several hundred thousand times per second, although, depending on the rotational rate of the core, they move very quickly.

Objects travelling via stutterwarp do not have a true velocity, despite appearances. If the stutterwarp drive is stopped, the vessel stops as well. While under stutterwarp, a vessel actually retains the velocity it had prior to the engagement of the drive and will once again resume moving at that velocity when the drive stops. Although this does present some difficulties in manoeuvring most pilots are up to the task.

The most important part of the stutterwarp drive is the stutterwarp core, an intricate spiral of superconducting ceramic doped with crystalline tantalum. This core is spun at over 100,000 RPM in a shielded chamber at the heart of the drive mechanism.

As the core jumps it carries the vessel along with it, thanks to the superconducting field it generates.

## STUTTERWARP TRAVEL

### STUTTERWARP NAVIGATION

Stutterwarp vessels travel from star-to-star, limited only by their range of 7.7 light years. Some starships can make that journey in less than two days, while others may take a couple of weeks, depending on their warp efficiencies.

The distance from star-to-star is determined by a relatively simple equation. All that is needed is the X,Y,Z coordinates, either from the world description in this book or from the Near Star List, from the back of this book. The distance from star to star is given by the formula:

$$D = (\sqrt{x^2 + y^2 + z^2}) - (\sqrt{x^2 + y^2 + z^2})$$

Example 1: The Sol System has the x,y,z coordinates of 0,0,0. Alpha Centauri, where the other core world of Tirane is located, has the coordinates of -1.7, -1.4, -3.9. Since Sol is at 0,0,0, we can ignore it for the equation.

$$\text{So for a trip from Earth to Tirane, } D = (\sqrt{(-1.7)^2 + (-1.4)^2 + (-3.9)^2}) = \sqrt{2.89 + 1.96 + 15.21} = 4.47 \text{ light years}$$

From Hochbaden to Eta Bootis, however, the calculation is a little longer. Hochbaden is at -24.9, -12.6, 14.3, while Eta Bootis is



at -26.8, -14.3, 10.2. The equation will look like this:  
 $D = (\sqrt{(-24.9)^2 + (-12.6)^2} + (14.3)^2) - \sqrt{(-26.8)^2 + (-14.3)^2} + (10.2)^2$   
 $(\sqrt{(620.01 + 158.76 + 204.49)} - \sqrt{(718.24 + 204.49 + 104.4)}) = \sqrt{983.26} - \sqrt{727.13} = 30.87 - 26.97 =$   
 3.87 light years from Hochbaden to the Eta Bootis system and the colony world of Aurore.

Plotting the most efficient course from star to star is a job for an Astrogator, along with a computer.

**PLOTTING A COURSE FROM STAR TO STAR:**

Formidable, Astrogation, Int  
 The time required to plot the course is equal to the Effect rolls x 30 minutes. The plot can be done while in transit to the edge of the Threshold.  
 DM + Computer model number

**PLOTTING A COURSE WHILE WITHIN A SYSTEM, FROM PLANET TO PLANET.**

Difficult, Astrogation, Int  
 Time required to plot the course is the Effect roll x 5 minutes. This can be done while the ship is in orbit or transiting up from orbit to the Wall.  
 DM + Computer model number

**DEAD RECKONING**

As stutterwarp travel takes place in real space, it is possible to fly a stutterwarp vessel by dead reckoning, which means to simply point the ship in the right direction and keep making manual course corrections along the way. This is difficult and takes longer to travel than with plotted courses but it is possible.

**DEAD RECKONING FLIGHT FROM PLANET-TO-PLANET**

Difficult, Pilot, Int  
 The Effect roll determines how much extra time the flight requires.  
 The Astrogation skill, at any level, give a DM +1 to this task.

**DEAD RECKONING FLIGHT FROM STAR-TO-STAR**

Difficult, Pilot, Int  
 The Effect roll determines how much extra time the flight requires.  
 The Astrogation skill, at any level, give a DM +1 to this task.

**Dead Reckoning Flight Table**

| Effect Roll 1d6 | Extra time required, interplanetary travel | Extra time required, interstellar travel |
|-----------------|--|--|
| 1               | +200%                                      | +400%                                    |
| 2               | +150%                                      | +300%                                    |
| 3               | +100%                                      | +200%                                    |
| 4               | +50%                                       | +100%                                    |
| 5               | +20%                                       | +50%                                     |
| 6               | +10%                                       | +25%                                     |

The Threshold: Stutterwarp drives exhibit a severe drop-off in efficiency when within a gravity well of 0.0001 G or greater. Stutterwarp efficiency falls off by an order of magnitude, reducing the vessel to sub-FTL speeds. The FTL Threshold is a reference to the distance from a system's star that stutterwarp performance degrades to the point where the ship drops below FTL speeds. To determine the stutterwarp shelf of any given system, use the following formula:

$R = 2.45 \times \text{Squareroot} (M)$

Where R is the star's threshold radius measured in astronomical units and M is the mass of the star measured in solar masses (1 solar mass = 1.99 x 10<sup>27</sup> tons).

On average, an M-class star has a mass of 0.25, K-class is 0.7, G-class is 1 and A is 2

To determine the stutterwarp threshold for any given planet, use the following formula:

$UWP \text{ World Size} \times 5,000\text{km} = AS$

AS = Altitude of stutterwarp threshold, in kilometres.

The Stutterwarp shelf would occur at roughly 40,000 kilometres above an Earth-sized world (as long as the world in question is in unstressed space).

The Wall: The Stutterwarp wall is the point at which stutterwarp efficiencies drop to the point where they end up being slower than conventional reaction drives. They are, however, still usable. This occurs within a gravity well of 0.1 G, which is also the minimum gravity well required for discharging a stutterwarp. To determine the FTL wall for any system, use the following formula:

$R = 0.078 \times \text{Squareroot} (M)$

**Naval Terminology**

Many space navies are based on their wet naval ancestors. In these militaries, alternate terms are used instead of Threshold and Wall.

The Deeps: The Deeps are the volume of unstressed space, where a starship can operate at FTL speeds, Deep space, in other words. The Deeps begin at the system Shelf.

The Shelf: Naval term for the Stutterwarp Threshold.

The Shallows: Volume of space between the system's Shelf and the Beach. FTL travel is not possible in the shallows.

The Beach: Naval term used for the Stutterwarp Wall. Operating too close to the edge of the Shallows might lead a vessel to accidentally lose stutterwarp headway and become Beached.

Where R is the star's wall radius, measured in astronomical units and M is the mass of the star measured in solar masses (1 solar mass = 1.99 x 10<sup>27</sup> tons).

Typically, an M-class star is 0.25, K-class is 0.7, G-class is 1 and A is 2

To determine the stutterwarp wall for any given planet, use the following formula:

$$\text{UWP World Size} \times 1,500\text{km} = \text{AW}$$

AW = Altitude of stutterwarp wall, in kilometres

The stutterwarp wall is approximately 12,000 kilometres above Earth.

**Orbital Transfers:** Beyond the wall, stutterwarp vessels are typically slower than reaction drives, their major advantage being that stutterwarp drives do not require any reaction mass. A stutterwarp drive can be used to manoeuvre from the Wall down to the low orbit range of most landers and spaceplanes. However, care must be taken to not enter an atmosphere with an operating stutterwarp, as quantum interactions will usually destroy the drive. Nor can a stutterwarp be used to land, even on an airless world, due to the risk of quantum interactions while under stutterwarp. Another issue is that the vessel has retained whatever velocity it had prior to the stutterwarp being engaged, which could present many problems. To avoid this risk, no ship will approach closer than the 0.95 G gradient, which for Earth is 165 kilometres.

**Speeds:** A stutterwarp operates at three speeds: FTL, sub-FTL and orbital. FTL speed is the listed speed of the vessel in light years/day. Sub-FTL speeds are used when the vessel has passed the stutterwarp shelf and are arrived at by multiplying the listed speed (in LY/day) by 0.645 to get the speed in AU/day. Orbital speeds are used after the ship has hit the Wall and are useful for little more than transfer orbits. Ships at orbital speed must subtract the world's surface gravity from their warp efficiency rating and then multiply the new number by 10,000 to determine their speed in kilometres per hour.

**Stutterwarp Control Programs:** The maximum speed of a stutterwarp vessel is limited by the stutterwarp control program. A good pilot can push a ship beyond the limits of the control program. Roll a Formidable Pilot Check, +Int. Speed increases by Effect x 0.5 light years/day.

### **Tantalum Availability**

Tantalum is a very rare element and the isotope Ta-180 even more so. The Ta-180 isotope is the only one that can be used in a stardrive. It has only a limited availability and although the quantities used in the construction of a stardrive are relatively small, it is still a managed resource. This limited availability ensures that only a limited number of ships can be built per year. A tantalum-180 find of any size is enough to make its discoverers very wealthy.

**Range:** Quantum interactions as the drive moves through space build up what some have dubbed a 'gravistatic' charge on the tantalum coils of a ship's drive. This is compounded by real-space intersections with hydrogen atoms and other bits of matter as the Stutterwarp moves along, interposing itself on each bit of space it jumps into. As the coils build up the charge, it starts to distort the crystal shape of the atoms in the drive coil. After a critical level has been reached, typically after 7.7 light years, the Tantalum drive core spontaneously decays into Hafnium and releases an intense, lethal burst of radiation. The radiation is of Lethal Severity and the discharge usually destroys the drive room, along with the drive. The radiation burst usually kills the crew outright.

Once a ship arrives in a gravity well of at least 0.1G, the ships can discharge the drive. The gravity well attracts the 'gravistatic' charge from the drive coils over the course of several hours, allowing the crystal structure of the coil to return to normal. Discharge time is a function of the distance travelled and take about six hours per light year travelled. Thus a full 7.7 light year voyage would take 44.2 hours to discharge.

**Delaying Discharge:** It is possible for a skilled Engineer to delay the discharge time by up to 24 hours. It is extremely difficult to do and the risks are likewise extremely high. Formidable Engineering, +1 DM per computer number,

The intent to Delay Discharge must be declared before the vessel starts out. The skill check is rolled for then but the Referee should keep the number a secret until the vessel passes 7.7 light years. If the roll failed, the drive core decays as described previously. If the roll succeeded, the ship can travel an additional day at full speed.

**Stutterwarp Communications:** The stutterwarp drive itself can be used to communicate. By flicking the drive on and off, gravitic pulses can be sent out and detected from anywhere in the system. These pulses are limited to light-speed but they are the most effective broadcast transmitter available. Any stutterwarp ship can transmit but a grav scanner is required to receive the signal. Communication rate is very slow, as each pulse takes over a second to send, so it is generally limited to short code phrases.

**Brown Dwarfs:** Brown Dwarfs are massive sub-stellar objects and are often described as failed stars. Many times larger than Jupiter, yet considerably smaller than the sun, Brown Dwarfs are another method to break the 7.7 light year barrier on Stutterwarp travel. They serve as a convenient discharge point in deep space and, unlike a much smaller rogue planet, are at least possible to discover.

### **Brown Dwarf Uses**

Astronomers suspect that there are many brown dwarfs and other interstellar planets out there. If you need a link to a system for your campaign, placing a brown dwarf is an easy option. Tugs and stations are harder options but perhaps more rewarding and less of a deus ex machina solution.

Brown dwarfs can be found in interstellar space but are difficult to detect and sometimes a brown dwarf is ideally placed to provide a bridge to stars that would otherwise be out of range of a stutterwarp drive vessel.

Appearance and Effects of Stutterwarp Travel: From a ship travelling less than the speed of light, there is no discernible change in the view outside the vessel. However, to an external viewer, a stutterwarp vessel moving at sub-light velocities appears to be blurred, with the blurring getting more pronounced the faster the vessel goes. This is a function of quantum indeterminacy, as the vessel's position becomes a probability cone rather than vector. To an extent the blurring effect is an optical illusion resulting from persistence of vision in the observer. Sensor systems are not so confused but still are unable to get an absolute lock on a stutterwarp vessel's position.

Once a vessel goes faster-than-light, the visual effects become even more spectacular. To an outside observer, the vessel is so blurred as to be practically invisible. This is an effect of both the probability cone of the vessel becoming very elongated and diffused and the persistence-of-vision illusion. However, as an FTL vessel comes up to an observer and passes them, a most unusual effect occurs. Although the vessel itself is practically invisible, the images of it as it stuttered along have more-or-less solidified and to the outside observer, as the vessel passes, he can see images of it moving away in both directions. The image moving in the direction the vessel came from is the termination image or chaser.

To an observer on the ship, the only thing most observers see is the stars becoming faint, diffused circles rather than points. This is an indeterminacy issue stemming from the drive. The most spectacular effect is the termination image mentioned earlier. Should the ship suddenly drop out of stutterwarp, all the light from previous positions of the ship will 'catch up' to the stopped vessel. The effect is as if the image is moving away, as light from the nearest points catches up first and the image seems to recede.

### STARSHIP OPERATING COSTS

| Service                  | Core Cost              | Frontier Cost          |
|--------------------------|------------------------|------------------------|
| Berthing Fees orbital    | Lv300 per ton per week | Lv150 per ton per week |
| Berthing Fees, Surface   | Lv30 per ton per week  | Free                   |
| OQC Inspection           | Lv3,000                | N/A                    |
| Fuel, per dton*          | Lv6,000                | Lv1,800                |
| Nuclear Reactor Core     | 40% of reactor cost    | 60% of reactor cost    |
| Reaction Mass, per dtonH | Lv3,000                | Lv900                  |

\*Power Plant fuel is both Liquid Oxygen (LOX) and Liquid Hydrogen (L-Hyd).

HReaction mass is liquid hydrogen and is only used for nuclear rockets. Conventional thrusters use the same fuel as Power Plants.

Nuclear (fission) reactors have to have their core replaced about every five years.

### CREW SALARIES

| Crew Position     | Standard Rate | Expert Rate (Primary Skill > 2) |
|-------------------|---------------|---------------------------------|
| Pilot             | Lv4,000       | Lv6,000                         |
| Navigator         | Lv3,000       | Lv4,500                         |
| Sensor Operations | Lv3,000       | Lv4,000                         |
| Engineer          | Lv4,000       | Lv5,500                         |
| Gunner            | Lv2,000       | Lv3,000                         |
| Small Craft Pilot | Lv3,000       | Lv4,500                         |
| Remote Pilot      | Lv3,000       | Lv4,000                         |
| Steward           | Lv2,000       | Lv4,000                         |
| Cargo Handler     | Lv1,000       | Lv1,500                         |
| Medical           | Lv4,000       | Lv6,000                         |

Pay rates are per month. Crew members on commercial vessels can elect to take cargo space in lieu of pay, at the rate of Lv500 per 0.25 tons of cargo space. This space can be used however the crew member wants, as long as it is not illegal and places no additional demands on the ship's systems or crew. This space is often used for personal storage, recreation or, most often, as freelance cargo space.

## CHARTER RATES

### INTERFACE VESSELS

Interface vessels are chartered by the hour, with a minimum of 12 hours, at a rate of Lv100 per ton of vessel per hour. This is further modified by the surface gravity (in Gs) of the world where the vessel is being chartered, with the lowest modifier possible being 0.1. So an 80 dton vessel, chartered for 20 hours on a 0.5 G world, would cost  $Lv100 \times 80 \times 12 \times 0.5 = Lv48,000$ .

### STARSHIPS

Starships are chartered for two weeks at a time.

| Vessel Type   | Accommodation                                 | Cost     |
|---|---|----------|
| Interface-capable                                   | Per ton of available cargo space              | Lv10,000 |
| Includes 1 complete interface operation per 2 weeks | Per Luxury Passenger accommodation available  | Lv10,000 |
|   | Per Economy Passenger accommodation available | Lv6,000  |
| Non-Interface Capable                               | Per dton of available cargo space             | Lv1,000  |
| All interface costs to be paid separately           | Per Luxury Passenger accommodation available  | Lv2,000  |
|   | Per Economy Passenger accommodation available | Lv1,000  |

## PASSENGERS

Passengers can provide a useful source of income. Passengers are attracted either by a starship's comfort level or by cost. The comfort level is used as a DM in any rolls to attract passengers.

However, costs are different. Use the following tables to determine interface costs, per passenger and further on the interstellar travel costs, per person. Travel costs for system ships are usually 10–20% of the cost of interstellar vessels.

## INTERFACE COSTS

Costs to and from orbit depend on vehicle type and world size.

|                | Passenger to orbit | Passenger From Orbit | Cargo (dton) To Orbit | Cargo (dton) From Orbit |
|----------------|--------------------|----------------------|-----------------------|-------------------------|
| Vehicle Type   |                    |                      |                       |                         |
| Spaceplane     | Lv5,000            | Lv500                | Lv20,000              | Lv2,000                 |
| Roton          | Lv6,000            | Lv600                | Lv30,000              | Lv3,000                 |
| Rocket         | N/A                | N/A                  | Lv15,000              | N/A                     |
| Catapault      | N/A                | N/A                  | Lv5,000               | N/A                     |
| Dead Glider    | N/A                | Lv400                | N/A                   | Lv2,000                 |
| Ballistic Drop | N/A                | Lv160                | N/A                   | Lv1,000                 |
| Beanstalk      | Lv1,000            | Lv500                | Lv5,000               | Lv5,000                 |

Costs for all interface transport are modified by the world's gravity. Multiply the cost from the table by world gravity (in Gs) to get the final cost.

Worlds without an atmosphere halve the costs to orbit and multiply costs from orbit by five (in other words, the cost to and from orbit is the same). The listed cost for the beanstalk is for any of the beanstalks in Human space, whether on Earth or Beta Canum. Tickets for luxury class can run between two and five times higher than those listed.

## STAR TRAVEL

Many commercial vessels carry passengers as well as cargo. The cost for interstellar travel depends on the distance covered and the comfort of the accommodations. There are two general classes of interstellar passenger, luxury and economy, which correspond to the Traveller classifications of High and Middle. A third type is found in 2300AD which is not found in Traveller: steerage. Steerage accommodations are not in actual cabins but rather in the cargo area when there is room left over. Steerage is often partly subsidised by governments, as they attempt to ship people off to the colonies. Frozen sleep roughly corresponds to Traveller's Low Berth but Frozen Sleep is technically a more difficult proposition in 2300AD than in Traveller and is usually only used for the bulk movement of colonists and animals, not for passengers. The costs listed in the following table are per light year travelled.

| Passage Type     | Minimum Comfort | Luggage Allowance | Cost/light-year     |
|------------------|-----------------|-------------------|---------------------|
| High (Luxury)    | 0               | 0.1 dton          | Lv500               |
| Middle (Economy) | -2              | 0.05 dton         | Lv100               |
| Steerage         | N/A             | N/A               | Lv50                |
| Frozen Sleep     | N/A             | 1 dton            | Lv2,000 (flat cost) |
| Cargo            | N/A             | N/A               | Lv750/dton          |

**High Passage:** High Passage includes a single-occupancy stateroom, the best meals and free access to all of the vessel's recreation facilities.

**Middle Passage:** Middle Passage includes either a double occupancy stateroom or a single occupancy cabin. Includes basic meals and access to the ship's recreation facilities at a pay-per-use rate.

**Steerage:** No room is provided for steerage passengers, who must either sleep in bunks or be housed in the vessel's cargo bay. One meal a day only is provided. Steerage passengers must buy or bring food for the other meals. No access to recreation facilities.

**Frozen Sleep:** Frozen sleep is only used for shipping large numbers of people or animals at once. It is not dangerous but it is debilitating. Passengers in Frozen Sleep lose one point each of STR, DEX and CON per month in the freezer tubes. Regaining these lost points takes 1d6/2 months, per point (so two points lost means 1d6 months to recover them all). Frozen sleep costs are per trip, not per light-year.

## COMFORT LEVEL

| Type of Accommodation | Comfort Level            |
|-----------------------|--------------------------|
| Small Cabin           | -1                       |
| Stateroom             | 0                        |
| Luxury Stateroom      | +2                       |
| Berth (Bunk)          | -2                       |
| Shared Accommodation  | Additional -1 per person |
| Artificial Gravity    | +2                       |

Comfort level affects all crew operations and is used as a modifier in all shipboard tasks.

## STARSHIP COMBAT

Starship combat in 2300AD uses the rules from Traveller, with a few changes, outlined here.

Stutterwarp travel introduces some interesting variables into the realm of combat. For vessels at FTL pseudo-velocities, ship-to-ship combat is effectively impossible. Targeting systems are unreliable, weapons are speed-of-light only and a ship's probability cone is so elongated that the chances of actually hitting it, even with a long burst, are minimal.

It is at sub-FTL velocities that actual starship combat can occur. Because a stutterwarping vessel does not present a target that can accurately be pinpointed, weapons fire is against the so-called 'probability cone' of a stutterwarp vessel, effectively all the points in space it could possibly appear in over a given space of time and for a given drive performance level. This actually involves a fair degree of human intuition, which is why human crews are still required to man and fire a ship's guns and control its missiles. Thus, all weapons fire in continuous bursts that last for most of a round, as the firing vessel attempts to blanket a hostile vessel's probability cone.

Once a hit has occurred, often the target vessel will have suffered serious damage. In particular, detonation lasers are liable to cripple or destroy smaller vessels and seriously damage or cripple even large vessels.

### **CHANGES TO BASIC STARSHIP COMBAT**

Only a few things are changed in the Basic system, as it is abstracted already. This combat system is intended for actions only involving a small number of ships.

Time scale: 2300AD starship Combat Rounds are three minutes long.

Ranges: 2300AD ranges are measured in light seconds or approximately 300,000 kilometres.

| Range     | Range Bands | Distance (kilometers) |
|-----------|-------------|-----------------------|
| Close     | <1          | <300,000              |
| Short     | 1–2         | 300,001–600,000       |
| Medium    | 2–5         | 600,001–1,500,000     |
| Long      | 5–10        | 1,500,001–3,000,000   |
| Very Long | 10–16       | 3,000,001–4,800,000   |

Compare this to standard Traveller, where even Distant range would be well within Close range for 2300AD.

The longest ranged weapons have a range of only three light seconds or Medium Range.

Movement and Manoeuvring: 2300AD does not have a thrust rating, instead there is the listed tactical movement. This is used instead of thrust to close range bands or manoeuvring.

Non-stutterwarp vessels: For the purpose of these rules, non-stutterwarp vessels are effectively standing still. Any attacking stutterwarp vessel receives a +2 DM bonus on all attack rolls and all weapons do double damage.

Missiles and Drones: In 2300AD, missiles and drones are treated just like any other vessel on the board, with one exception; missiles and drones always move last. Missile sensors are forward-looking only, not all-around like ships and sensor drones. Missiles are launched during the combat phase, while drones are launched during the Ship Action Phase. A ship must have a controller for each missile or drone in flight.

Submunitions: Submunitions are dropped during the Manoeuvre Phase. They can be detonated at any time during the weapons fire phase as long as the controlling ship is between Short and Long Range. A submunition's safeties can be overridden and they can be detonated while the firing ship is at Close range but the net effect is something very like suicide.

Submunitions have a rate-of-fire. They can drop any number of submunitions up to the listed rate of fire but all weapons detonated in the same round must target the same object.

Giant Emitters: Detonation missiles and submunitions block all sensors for 2d6 rounds or until a ship is clear of the range bands where they detonated.

Example: The Kennedy fires two SIM-14 missiles while at Long range. In two rounds the missiles close with the lead ship of the attacking force and detonate. The remainder of the ships from the attacking force cannot see past the expanding ball of radioactive fury for 2d6 rounds. Passing through a giant emitter has no ill effects. Stopping in the middle of a giant emitter subjects the vessel to a Severe radiation hazard.

UTES and TTAs: Weapons are assigned to TTA (Target Tracking Arrays) during the design process. During combat, any weapons controlled by a specific TTA all have to attack the same target. UTES (Unified Tracking and Engagement Systems), however, are part of each weapon mount and so each mount can target independently.

Cover: Planets and asteroids do not provide cover, unless a ship is, in game terms, right beside them. A ship has to be at close range to an object to receive any cover benefits. Stars provide full cover for anything behind them.

Engagement Angle and Firing Aspects: In basic combat, all combat is between small groups of vessels and will have one of two Engagement Angles; Head-On or Stern Chase. In a head-on engagement, any gun that can fire into aspects 1,2 and 6 can target the other vessel. In a stern chase, the chased vessel can fire guns from aspects 3,4 and 5 while the chaser can fire guns in aspects 1, 2 and 6.

### **ORDER OF EVENTS**

1. Setup
  - a. Determine range between ships.
  - b. Determine crew positions.
  - c. Determine Initiative.
2. Sensor Phase
  - a. Sensors operators and their computers try to pinpoint a ship sufficiently to hand off a targeting solution to the gunner.
  - b. Sensor operators and their computers try to get more information from target.
3. Manoeuvre Phase
  - a. The position of ships is changed based on their thrust.
  - b. Submunitions are dropped.
4. Combat Phase

- a. In order of Initiative, ships can take actions.
- b. Actions include: firing energy weapons and railguns, detonating submunitions, detonating missiles, launching missiles, boarding actions.
- c. Reactions include: dodging, point defence, activating screens.
- d. Actions are resolved.

5. Ship Action Phase

- a. In order of Initiative ships can take actions.
- b. Actions include: repairing damaged systems, launching craft, launching drones
- 6. Go to step 2.

**SENSORS PHASE**

While a starship is easy enough to see, thanks to the heat and grav signatures, is it not as easy to pinpoint sufficiently to allow accurate weapons fire.

An Average Sensors task is required each round to lock the sensors on a target. DMs are the computer's Model number, operators Skill and, as a negative, the number of range bands between the two vessels and the target vessel's tactical speed. Any target DMs from radiators, gun towers and spin habitats are also included. Finally, there is a DM based on the TL difference between the ships

| Modifier             | DM                                      |
|----------------------|---|
| Spin Hab             | 0 to +3                                 |
| Oversized Radiator   | +1                                      |
| Deployed Solar Array | +1                                      |
| Gun Tower            | +1                                      |
| Heavy Gun Tower      | +2                                      |
| Computer Model       | + model number                          |
| Stealth              | -4                                      |
| Movement             | -tactical speed of target               |
| Range                | Range bands between target and attacker |

Example: The Kennedy-class cruiser USSC Calvin Morrison is

trying to get a lock on a pirate vessel. The pirate has a gun tower, a deployed spin hab and an over-sized radiator, for a total ship DM of +3. Its tactical speed is five and it is seven range bands from the Calvin Morrison, for a DM of -9. The Calvin Morrison has a model 6 computer and the Sensor operator has a skill of 2, for a DM of +8. (+3-12+8=-1) Total DM for all Sensor Checks, then, is -1.

On the other hand, the pirate vessel is attempting to pinpoint the Calvin Morrison. The cruiser is running with spin hab retracted and has standard-sized radiators. It also has no gun towers or other external accessories. It is stealthed (-4 DM) and has a tactical speed of eight and is likewise seven range bands away. Total DM for the Calvin Morrison is -19. The pirate has a model 5 computer and her sensor operator only has a skill of 1, for a DM of +6. Total DM for the pirate's firing solution check against the Calvin Morrison is (-19+6 = -13) a total of -13. The pirate does not stand a chance.

Active vs. Passive Sensors: Passive sensors have a shorter range than active sensors and are not detectable in use. Using active sensors, however, will give any ship in range a +4 DM in attempts to pinpoint the vessel for targeting purposes. There is no bonus for an information scan.

Informational scan: This is an attempt by the scanning vessel to gather information on the target vessel. Use the details from the Sensors table on page 144 of the Traveller Core Rulebook, substituting 2300AD's range bands in place of Traveller's. All the same DMs apply.

Use the differences outlined with the standard combat system in the Traveller Core Rulebook.

# STARSHIP ENCOUNTERS

Encountering another starship or any facility, in the depths of space can be an opportunity for adventure. Whether it is a market tip exchanged with an old Libertine friend or a chance boarding by bored customs officials, starship encounters are a good occasion for the referee to move things along or introduce something new.

Encounters also help to define a star-system. The Core worlds of Earth and Tirane are teeming with starships, system ships and space stations, while the Frontier worlds see considerably less traffic in comparison. The encounter charts reflect this, along with reflecting the differences between the three Arms of exploration. The encounter charts are organised into several sections, one for the Core worlds and another for each of the Arms of space.

## CORE ENCOUNTERS

Core Encounters are used for both the Sol system and the Alpha Centauri system. Encounters are rolled once for every four hours in the outer system, once every two hours in the inner system and every hour in the vicinity of the main world. Unlike Frontier worlds, which roll a chance of an encounter, in the Core systems transiting ships will have a noteworthy encounter on a regular basis.

## OUTER SYSTEM ENCOUNTERS

The outer system denotes everything from the FTL shelf inward to 0.5 AU out from the main world.

| Roll3d6 | Outer System Encounters |
|---------|-------------------------|
| 3       | Artificial debris       |
| 4-5     | Asteroidal debris       |
| 6-8     | Naval patrol            |
| 9-10    | Inbound freighter       |
| 11-12   | System ship             |
| 13-14   | Outbound freighter      |
| 15-16   | Mining vessel           |
| 17      | Telescope array         |
| 18      | Pirate                  |

## INNER SYSTEM ENCOUNTERS

The Inner System covers all traffic within 0.5 AU of Earth or Tirane.

| Roll 3d6 | Inner System Encounters |
|----------|-------------------------|
| 3        | Asteroidal debris       |
| 4-5      | Naval patrol            |
| 6-8      | Inbound freighter       |
| 9-12     | Outbound freighter      |
| 12-15    | System ship             |
| 16-17    | Naval patrol            |
| 18       | Artificial debris       |

## MAIN WORLD ENCOUNTERS

Main world is considered to be all orbital space of a main world, out to the orbit of its farthest moon, including any orbital habitats.

| Roll 3d6 | Main world Encounters |
|----------|-----------------------|
| 3        | Habitat               |
| 4        | Power satellite       |
| 5-7      | Station               |
| 8-10     | Inbound freighter     |
| 11-13    | Outbound freighter    |
| 14-15    | Patrol                |
| 16-17    | OTV                   |
| 18       | System Ship           |

## EXPLANATION OF ENCOUNTERS

**Artificial Debris:** This could be anything from jettisoned garbage to the remains of a 20th Century space probe. Likely worthless but a probe would be priceless.

**Asteroidal Debris:** This is typical space junk and should not present a hazard to a stutterwarping vessel. A vessel travelling in real space, however, would have to be careful.

**Freighter:** This indicates a brief encounter with a freighter, either transiting into or out of the system.

| Roll 2d6 | Freighter |
|----------|-----------|
| 2–5      | Light     |
| 6–9      | Medium    |
| 10–12    | Heavy     |

A light freighter is a small courier, like a Thorez or other small, quick mercantile vessels. Medium size is an Anjou or its ilk, while Heavy is a super-freighter, like the Mammoth.

Freighter Ownership: Freighter ownership helps determine what sort of reaction they will have to incoming vessels and also gives the encounter some flavour. Corporate and governmental vessels are not likely going to want to talk but Foundation vessels and independents may. Note that Libertine traders do not do business in the Core worlds.

| Roll 3d6 | Ownership                   |
|----------|-----------------------------|
| 3–7      | Corporate Vessel            |
| 8–12     | Government Cargo Vessel     |
| 13–17    | Foundation Vessel           |
| 18       | Independent (Non-Libertine) |

Habitat: This is an extremely large space station, ranging from about one kilometre in diameter all the way up to massive six kilometre diameter by 40 kilometre long O’Neill Island 3 habitats. Even in Earth orbit, habitats of this size are very rare, with most relegated to the L1, L4 and L5 points. Only Gateway at Earth and Freihafen Orbital at Tirane, approach this sort of titanic size outside of the LaGrange points.

Mining Vessel: These long-haul mining vessels work the asteroid belt and planetary ring systems. They are often good sources of trade, in particular for luxury items. Most mining vessels are modified cargo vessels, although there are a few purpose-built vessels, like the ungainly Dalton, the spindly OMS Andrew Carnegie class and other more specialised vessels.

Naval Patrol: A Naval Patrol consists of a number of vessels. Most of the time, they will leave civilian traffic alone or just do a flyby and scan as they check for pirates. If boarding is required a boarding team will consist of 6–12 Marines in vacuum combat dress, armed with lasers, along with a couple of naval officers.

| Roll 3d6 | Naval Patrol | Number                           |
|----------|--------------|----------------------------------|
| 3–7      | Fighters     | 2d6                              |
| 8–10     | Destroyer    | 1d6                              |
| 11–13    | Frigate      | 1d6                              |
| 14–16    | Cruiser      | 1d6/2                            |
| 17–18    | Battle group | (Roll three times on this table) |

The reactions of a naval task force to ships they encounter depends on many factors but nationality is one of the most important ones. Determine the nationality of the naval vessels and compare them with the list of national rivals on page 9 of the Background Chapter.

| Roll 3d6 | Naval Patrol Reaction   |
|----------|---|
| -1–2     | Hostile; Fires warning shot and requires ship to heave to and prepare to be boarded |
| 3–5      | Requires Inspection before ship may proceed   |
| 6–9      | Requires transponder codes and manifests  |
| 10–14    | None  |
| 15–19    | Offers formal greeting and advisory   |
| 20+      | Offers friendly greeting  |

| Situation                  | Modifier |
|----------------------------|----------|
| Ship is from rival nation  | -4       |
| Ship is from same nation   | +4       |
| Ship is from allied nation | +2       |
| Ship from neutral nation   | 0        |

OQC Encounters: An OQC encounter indicates a meeting with Orbital Quarantine Command. Fighters will do a quick scan, along with typical radio chatter and interrogation: Where are you going? What is your cargo? How many passengers, names, destinations and other questions of that sort. An encounter with a cutter or a frigate indicates that the vessel will be boarded by an OQC search team, who will be very thorough in their scans and checks of the ship and its cargo. OQC search teams consist of 6 OQC Marines, along with one or two Inspection Officers.

| Roll 2d6 | OQC encounter | Number |
|----------|---------------|--------|
| 2–5      | Fighters      | 2d6    |
| 6–9      | Cutter        | 1d6    |
| 10–12    | Frigate       | 1d6/2  |

Pirates: Pirates are extremely rare in the Core systems. Naval forces are particularly ruthless about eliminating armed threats in the Core. Any pirates encountered will have to be determined or desperate or both.

| Roll 2d6 | Pirate/Raider        |
|----------|----------------------|
| 2–6      | Fighters w/freighter |
| 7–10     | Armed Freighter      |
| 11–12    | Frigate              |

Pirates will attempt to disable attacked vessels and force surrender. Boarding parties will consist of at least half the pirate’s crew, all in p-suits and heavily armed. If they get what they want, they will generally leave a crew unmolested but any resistance or a lack of booty, will lead them to take out their frustrations on the captured vessel’s crew.

Space Station: A space station is a larger facility than a work-shack and is usually a large-diameter toroidal station, spinning to produce internal gravity. These stations act as housing for orbital workers, warehouses and orbital terminals. These can be destinations for arriving traffic or departure points for outgoing traffic.

System Ship: A system ship is a low-power stutterwarp vessel, usually some sort of large bulk hauler. Tankers carrying fuel and chemicals from the outer planets are the most common type of these vessels.



Telescope Array: Far away from polluting electromagnetic sources, these vast optical and radio telescopes scan the stars. These long-baseline array telescopes are extremely sensitive and it is against the law to approach them without express permission.

Workshack: A workshack is a small, modular space station, usually housing a small laboratory or zero-gee factory. They may be manned or unmanned.

## NATIONALITY OF SPACE TRAFFIC OR SPACE STATION

| Terran System |             |
|---------------|-------------|
| Roll 3d6      | Nationality |
| 3-5           | Russian     |
| 6-8           | German      |
| 9-10          | British     |
| 11-13         | French      |
| 14-16         | Manchurian  |
| 17            | American    |
| 18            | Other       |

| Tirane System |             |
|---------------|-------------|
| 3d6 Roll      | Nationality |
| 3-4           | American    |
| 5-7           | British     |
| 8-9           | Wellon      |
| 10-12         | French      |
| 13-15         | Freihafener |
| 16-17         | Manchurian  |
| 18            | Other       |

## FRONTIER ENCOUNTERS

The chance of an encounter in a system on the Frontier is based on the UPP Population digit for the main world. This number or lower must be rolled on 2d6 for an encounter to occur, modified by the following table.

| Encounter Situation  | DM |
|----------------------|----|
| Naval Base in System | -2 |
| Class A Starport     | -2 |
| Class B Starport     | -1 |
| Class D Starport     | +1 |
| Chinese Arm          | +1 |
| American Arm         | +1 |

## SYSTEM ENCOUNTERS

Check every six hours for a system encounter. System encounters in the Frontier are all locations outside the immediate volume of space around a system's main world.

| Roll3d6 | French Arm         | Chinese Arm        | American Arm       |
|---------|--------------------|--------------------|--------------------|
| 3       | Asteroidal debris  | Asteroidal debris  | Asteroidal debris  |
| 4-7     | Naval patrol       | Naval patrol       | Naval patrol       |
| 8-9     | Inbound freighter  | Inbound freighter  | Inbound freighter  |
| 10-11   | Outbound freighter | Outbound freighter | Outbound freighter |
| 12-13   | Mining vessel      | Mining vessel      | Mining vessel      |
| 14-15   | Pentapod Merchant  | Sung Explorer      | Pirate/raider      |
| 16-17   | Pirate/raider      | Pirate/raider      | System ship        |
| 18      | System ship        | System ship        | Asteroidal Debris  |

## MAIN WORLD ENCOUNTERS

Check for an encounter every two hours in main world orbit. Main world orbit is defined as within the orbit of the planet's furthest moon or else the planet's stationary orbit should it lack moons.

| Roll3d6 | French Arm         |       | Chinese Arm        |       | American Arm       |
|---------|--------------------|-------|--------------------|-------|--------------------|
| 3-5     | Work-shack         | 3-5   | Work-shack         | 3-4   | Work-shack         |
| 6-7     | Orbital Terminal   | 6-7   | Orbital Terminal   | 5-6   | Orbital Terminal   |
| 8-9     | Inbound Freighter  | 8-9   | Inbound Freighter  | 7-9   | Inbound Freighter  |
| 10-11   | Outbound Freighter | 10-11 | Outbound Freighter | 10-12 | Outbound Freighter |
| 12-13   | System Ship        | 12-13 | System Ship        | 13    | System Ship        |
| 14-16   | Naval Patrol       | 14-17 | Naval Patrol       | 14-16 | Naval Patrol       |
| 17      | Pirate/Raider      | 18    | Pirate/Raider      | 17-18 | Pirate/Raider      |
| 18      | Pentapod Merchant  |       |                    |       |                    |

## EXPLANATION OF ENCOUNTERS

Asteroidal Debris: See page 270.

Freighter: See page 240 but refer to the following table also.

| Freighter |            |       |             |       |              |
|-----------|------------|-------|-------------|-------|--------------|
| Roll 2d6  | French Arm |       | Chinese Arm |       | American Arm |
| 2-5       | Light      | 2-4   | Light       | 2-5   | Light        |
| 6-8       | Medium     | 5-10  | Medium      | 6-9   | Medium       |
| 9-12      | Heavy      | 11-12 | Heavy       | 10-12 | Heavy        |

Freighter Ownership: Freighter ownership helps determine what sort of reaction they will have to incoming vessels and also gives the encounter some flavour. Corporate and governmental vessels are not likely to want to talk but Foundation vessels and independents may. Libertines will only talk on a quid pro quo basis, nothing for nothing. However, they can be good sources of information.

Roll on the following table to determine the ownership of any encountered commercial vessel.

#### Ownership

| Roll2d6 | French Arm        |       | Chinese Arm       |       | American Arm      |
|---------|-------------------|-------|-------------------|-------|-------------------|
| 2-3     | Corporate Vessel  | 2-3   | Corporate Vessel  | 2-3   | Corporate Vessel  |
| 4-6     | Government Vessel | 4-6   | Government Vessel | 4-7   | Government Vessel |
| 7-8     | Foundation Vessel | 7     | Foundation Vessel | 8-9   | Foundation Vessel |
| 9-10    | Libertine Trader  | 8-10  | Libertine Trader  | 10    | Libertine Trader  |
| 11-12   | Independent       | 11-12 | Independent       | 11-12 | Independent       |

Naval Patrol: Naval Patrols are usually involved in their own duties and are not likely to bother small vessels. There is a possibility, however. On a 2d6 roll of 8+, they will make a roll on the reaction table to determine their response. If boarding is required a boarding team will consist of 6-12 Marines in vacuum combat dress, armed with lasers, along with a couple of naval officers.

If a battle group is rolled, consult the following table and roll the appropriate die. That is the number of times you roll on the naval patrol table, to determine the size of the task force. The largest vessel in the task force is also the flagship, carrying an admiral aboard.

| Battle groups | Number of times to roll on table |
|---------------|----------------------------------|
| French Arm    | 1d6+2                            |
| Chinese Arm   | 1d6                              |
| American Arm  | 1d6                              |

#### Naval Patrols

| French Arm |              |       | Chinese Arm |              |       | American Arm |              |       |
|------------|--------------|-------|-------------|--------------|-------|--------------|--------------|-------|
| Roll3d6    | Naval Patrol | No.   | Roll3d6     | Naval Patrol | No.   | Roll 3d6     | Naval Patrol | No.   |
| 3-7        | Fighters     | 2d6   | 3-7         | Fighters     | 2d6   | 3-7          | Fighters     | 2d6   |
| 8-10       | Destroyer    | 1d6   | 8-10        | Destroyer    | 1d6   | 8-9          | Destroyer    | 1d6   |
| 11-13      | Frigate      | 1d4   | 11-14       | Frigate      | 1d6+1 | 10-13        | Frigate      | 1d6+1 |
| 14-16      | Cruiser      | 1d4/2 | 15-17       | Cruiser      | 1d6/2 | 14-17        | Cruiser      | 1d6/2 |
| 17-18      | Battle group |       | 18          | Battle group |       | 18           | Battle group |       |

The reaction of a naval task force to ships they encounter depends on many factors but nationality is one of the most important. Determine the nationality of the naval vessels and compare them with the list of national rivals on page 9.

#### Naval Patrol Reaction Table

| Roll3d6 | Naval Patrol Reaction   |
|---------|---|
| -1-2    | Hostile; Fires warning shot and requires ship to heave to and prepare to be boarded |
| 3-5     | Requires inspection before ship may proceed   |
| 6-9     | Requires transponder codes and manifests  |
| 10-14   | None  |
| 15-19   | Offers formal greeting and advisory   |
| 20+     | Offers friendly greeting  |

| Situation                  | Modifier |
|----------------------------|----------|
| Ship is from rival nation  | -4       |
| Ship is from same nation   | +4       |
| Ship is from allied nation | +2       |
| Ship from other nation     | 0        |
| French Arm                 | -2       |
| American Arm               | +2       |

Pentapod Trader: A Pentapod trade vessel is a Starwhale-class vessel, accompanied by several landing craft. They will often have a guard unit with them (1-2 on a d6) of 1-3 (1d6/2) Void-sharks. They are willing to stop and trade with just about anyone. Pentapod Vessels are only encountered on the French Arm.

Pirates and Raiders: Pirates and raiders are forces to be feared for most merchant vessels but are no match for any military force. Warships possessed by these groups are likely to be decades-old Manchurian or Indonesian surplus, with a leavening of French vessels for variety.

#### Pirate Raiders

| Roll2d6 | French Arm           |       | Chinese Arm          |      | American Arm         |
|---------|----------------------|-------|----------------------|------|----------------------|
| 2-4     | Fighters w/freighter | 2-3   | Fighters w/freighter | 2-5  | Fighters w/freighter |
| 5-9     | Armed Freighter      | 4-10  | Armed Freighter      | 6-11 | Armed Freighter      |
| 10-12   | Frigate              | 11-12 | Frigate              | 12   | Frigate              |

Pirates and raiders will almost always try to force vessels to surrender and see no profit in wholesale destruction. Although a starship is likely more valuable than its cargo, it is also harder to hide and there is also the problem of captives. Most pirates would rather avoid killing prisoners, not out of humanitarianism but to avoid the inevitable naval crackdown that such activities engender.

Pirates are more concerned with attacking spacecraft, while raiders use their capabilities to raid planets and outposts for their booty.

Both types will eventually end up using troops, one to board and confiscate any valuables and the other to land on a planet and do much the same thing. Boarding and landing troops use either the pirate or mercenary troops from the NPC section of this book (pages 278 and 279 respectively).

**System Ship:** A system ship is a low-power stutterwarp vessel, usually some sort of mining or prospecting vessel.

**Workshack:** A workshack is a small, modular space station, often serving as an orbital terminal for smaller worlds or a laboratory involved in the colonisation effort.

Nationality of Space Traffic or Station: Roll on the following table to determine the nationality of any encountered vessel in Frontier space.

| Roll3d6 | French Arm |       | Chinese Arm        |       | American Arm |
|---------|------------|-------|--------------------|-------|--------------|
| 3       | Elysian    | 3-4   | Canadian           | 3-4   | Nigerian     |
| 4       | Manchurian | 5-6   | Life Foundation    | 5-9   | Australian   |
| 5       | Japanese   | 7-8   | Mexican            | 10-14 | American     |
| 6-8     | French     | 9-12  | Manchurian         | 15-17 | Trilon       |
| 9-11    | German     | 13-14 | Argentinean        | 18    | Other        |
| 12-14   | British    | 15-16 | Texas              |       |              |
| 15-16   | Ukrainian  | 16    | Scandinavian Union |       |              |
| 17      | American   | 17    | Texan              |       |              |
| 18      | Other      | 18    | Other              |       |              |

# NPCs AND ANIMALS

## NON-PLAYER CHARACTERS

Non-Player Characters (NPCs) are the rest of the inhabitants of the game universe, from the people just strolling down to the street to the augmented assassin hunting his target. They are there to provide opportunities for interaction, whether that is to provide information or combat or just background colour.

### **NPC MOTIVATIONS**

Much like PCs, NPCs also have motivations that lie behind everything that they do. In many cases, however, the motivations of NPCs are either obvious or unimportant. For example, general background characters, such as merchants or enemy soldiers, do not require a precise definition of motivation. Motivation becomes necessary, however, with influential or potentially Important NPCs.

Like PCs, their motivations are based on the standard deck of cards. If the Referee chooses to assign NPC motivations randomly, use the full deck and add both Joker cards. Otherwise, simply assign NPCs a motivation

To determine NPC motivation, draw two cards from a standard deck of playing cards. The highest value card is the NPC's prime motivation, the other is his secondary motivation. The particular motive is determined by the suit of the card. Card values may be low (2, 3 or a 4), middle (5,6 or 7) or high (8,9 or 10). Aces and face cards have their own special meaning.

### **CLUBS**

Clubs Motivation NPCs add +1 to Str.

The club suit indicates that violence plays a part in the NPC's makeup.

Low: The NPC is not frightened or intimidated by violence or its threat.

Middle: The NPC is aggressive and accepts violence as a means of solving problems.

High: The NPC loves a good fight. But this does not, however, indicate cruelty or brutality.

Jack: The NPC is subjected to sudden, violent and uncontrollable rages.

Queen: The NPC is stubborn, nearly impossible to persuade once he has made up his mind.

King: The NPC is a sadistic brute who enjoys inflicting pain on others.

Ace: The NPC is a natural military leader with an instinctive grasp of tactics and a good eye for terrain. The Referee should have him anticipate many situations and make allowances for them.

### **DIAMONDS**

Diamonds Motivation NPCs add +1 to Int.

The diamonds suit indicate that the NPC has a concern for wealth.

Low: The NPC is cost-conscious and interested in making money.

Middle: Making money is always the NPC's first consideration and he will always haggle over prices and wages.

High: Easy to bribe and might betray his friends if the price is right.

Jack: He is a total coward and will run from danger at every opportunity.

Queen: The NPC is driven by lust for the opposite sex, either for a particular person or just in general.

King: He is obsessed with money, believes everything has a price and will do anything if the price is right.

Ace: He is generous to a fault and gladly gives whatever he has to those in need.

### **HEARTS**

Hearts Motivation NPCs add+1 to Soc.

The hearts suit indicates that social interactions are very important to the NPC.

Low: Amiable and cooperative.

Middle: Indicates a willingness to take responsibility and a desire for a position of importance.

High: Ambitious and manipulates the people around him for his own end.

Jack: Has a strong commitment to fairness and reacts with anger to injustice and brutality.

Queen: He will let nothing stand in the way of achieving any goal. He can appear to be considerate, generous, loyal or anything else which serves his purpose but beneath the exterior, he ruthlessly uses others for his own gain.

King: He is scrupulously honest and his word of honour is his absolute bond. He has contempt for liars and anyone who breaks their word.

Ace: He sees justice as the greatest virtue and the only important consideration in deciding on a course of action. He hates cheats, liars and crooks and will always assist any attempt to right an injustice.

### SPADES

Spade Motivation NPCs add +1 to Int.

The spades suit indicates that the NPC is motivated primarily by curiosity and a desire for knowledge.

Low: Someone who is mildly curious but will not take any risks to satisfy that curiosity

Middle: Indicates a willingness to take responsibility and a desire for a position of importance.

High: Indicates someone who is driven to find new knowledge and will not let things stand in their way.

Jack: He is pompous and arrogant and clearly considers himself smarter than others.

Queen: He is blinded by the pursuit of knowledge or enlightenment and is oblivious to the consequences of their actions.

King: Rather than searching for the truth, he actively suppresses uncomfortable truths and leads others astray.

Ace: He is a charismatic natural teacher who draws others to him and inspires them.

### JOKERS

Jokers indicate that the NPC's sanity is in question.

Minor (Replacement) Joker: The NPC is a harmless and entertaining eccentric.

Major Joker: The NPC may actually appear to be completely normal or very eccentric but he is genuinely and hopelessly insane. The direction of his insanity is indicated by his other motivation card.

### QUICK NPCs

It is often not necessary to generate a full, complex character for a given situation. In particular, faceless goons or a street crowd, do not all need detailed stats. In these cases, NPCs are assigned one of four levels of competence and designated as either combatants or non-combatants and given a primary motivation (one draw from the deck or one choice).

Each NPC will have one skill from the list at the first level and all other skills at the second level.

Green NPCs have completely average Characteristics. More experienced NPCs can modify Characteristics, adding +1 to one Characteristic at Average and another +1 to any two Characteristics at Experienced and so on. The following below shows the cumulative Characteristic increase.

### Non-combatants

| Experience Level | Skills                                    | Levels | Traits             | Characteristics |
|------------------|---|--------|--------------------|-----------------|
| Green            | Drive, Carouse                            | 0/0    | Contact            | 777777          |
| Average          | Drive, Trade Carouse                      | 1/0    | Contact, Dependent | +1              |
| Experienced      | Drive, Admin, Carouse, Trade              | 2/1    | Ally, Dependent    | +2, +1          |
| Elite            | Drive, Admin, Carouse, Trade, Investigate | 3/2    | Ally, Common Sense | +3, +2, +1      |

### Combatants

| Experience Level | Skills  | Levels | Traits                       | Characteristics |
|------------------|---|--------|------------------------------|-----------------|
| Green            | Gun Combat, Melee, Drive                                | 0/0    | Contact                      | 777777          |
| Average          | Gun Combat, Melee, Drive, Recon                         | 1/0    | Fearless                     | +1              |
| Experienced      | Gun Combat, Melee, Drive, Recon, Heavy Weapons          | 2/1    | Tough/1, Coolness under Fire | +2, +1          |
| Elite            | Gun Combat, Melee, Drive, Recon, Heavy Weapons, Tactics | 3/2    | Tough/2, Coolness under Fire | +3, +2, +1      |

When noting down Quick NPCs, all that needs to be noted are any exceptional skills or Characteristics.

So, an Elite Combatant would be noted as:

Elite Combatant, Gun Combat, Dex +3, Str +2, Int +1, Clubs 5 (+1 Str)

This translates to

Str 10 End 7 Dex 10 Int 8 Edu 7 Soc 7, Gun Combat/3, Melee/2, Drive/2, Recon/2, Heavy Weapons/2, Tactics/2 Tough/2, Coolness Under Fire

Then these Quick NPCs just need basic equipment and armour and they are quickly ready to go.

# SAMPLE NPCS

The following Non-Player Characters can be used as contacts, allies, adversaries or other citizens of the world.

## SECTION 1: CIVILIANS

### Bandits/Guerrillas

Bandits represent the average foot soldiers in gangs of rural robbers or the troops serving revolutionary causes throughout the various colonies. They are not well-trained or highly disciplined and if at all possible do not engage in stand-up fights with regular troops.

| Character | Career Path                                 | Str | Dex | End | Int | Edu | Soc |
|-----------|---|-----|-----|-----|-----|-----|-----|
| Bandit    | Frontier (homesteader) 1<br>Rogue (thief) 1 | 8   | 7   | 8   | 7   | 6   | 6   |

Gun Combat (slug rifle) 1, Melee (blade) 1, Stealth 1, Survival 1, Animal 0, Athletics 0, Carouse 0, Computers 0, Drive 0, Jack of All Trades 0, Mechanic 0, Medic 0, Navigation 0, Recon 0.

Traits: Coolness Under Fire, Fearless, Manic.

Motivation: Clubs 5, Diamonds 1: They want a better life and are quite willing to kill to get it.

DNAMs: Colonist Standard Package + Hot Inertial Armour Vest, M-2 Assault Rifle, Dagger.

### Bureaucrat

All across Human space, there are bureaucrats and functionaries who interact with Player Characters, often in adversarial roles. Despite this, bureaucrats are the ones who keep civilisation moving.

| Character    | Career Path            | Str | Dex | End | Int | Edu | Soc |
|--------------|------------------------|-----|-----|-----|-----|-----|-----|
| Bureaucrat 1 | Frontier (corporate) 2 | 6   | 7   | 6   | 8   | 8   | 7   |

Admin 1, Diplomat 1, Informatics 1, Admin 0, Advocate 0, Broker 0, Computers 0, Diplomat 0, Drive 0, Language 0, Leadership 0, Mechanic 0.

Common Traits: Empath.

Motivation: Hearts 5, Spades 2: AT the more they just want to be helpful. Their natural curiosity makes them delve deeper into problems than they should.

DNAMs: Colonist Standard Package.  
Link phone, Computer, Neural Jack

| Character    | Career Path                                      | Str | Dex | End | Int | Edu | Soc |
|--------------|--|-----|-----|-----|-----|-----|-----|
| Bureaucrat 2 | Core (corporate) 4<br>Nobility (administrator) 1 | 5   | 6   | 6   | 10  | 10  | 10  |

Admin 2, Informatics 2, Advocate 1, Broker 1, Diplomat 1, Carouse 0, Comms 0, Computers 0, Leadership 0, Social Sciences 0.

Common Traits: Arrogant, Common Sense, Dark Secret, Longevity, Wealthy.

Motivation: Diamonds 5  
Diamonds 4: Their job is the accumulation of money

Common DNAMs: Usually none.

Hand Computer, Subdermacomp, Neural Jack, Link phone,

### Colonist

These represent a typical second- or third-generation colonist from the American Arm. Well-supplied and equipped, he is also a rugged individualist determined to make it far away from the prying government eyes of Earth.

| Character | Career Path              | Str | Dex | End | Int | Edu | Soc |
|-----------|--------------------------|-----|-----|-----|-----|-----|-----|
| Colonist  | Frontier (homesteader) 2 | 8   | 7   | 9   | 7   | 7   | 6   |

Animal (farming) 1, Jack of All Trades 1, Survival 1, Athletics 0, Computers 0, Drive 0, Gun Combat 0, Mechanic 0.

Common Traits (0-4): Internal Map, Poor, Sixth Sense, Tough.  
Motivation: Spades 5, Hearts 4.

Common DNAMs: Colonist Standard Package  
Rifle, Comm, Binoculars.

### Scientist

The field scientist (geologist shown) is often encountered on frontier worlds and may even serve as a patron for a group of Player Characters. Of course, a scientist may be on the opposite side, working to thwart the players using her resources and those of her hired hands.

| Character   | Career Path                | Str | Dex | End | Int | Edu | Soc |
|-------------|----------------------------|-----|-----|-----|-----|-----|-----|
| Scientist 1 | Scholar (field research) 3 | 6   | 7   | 7   | 11  | 12  | 8   |

Investigate 2, Computers 1, Life Sciences (biology) 1, Physical Sciences (chemistry) 1, Social Sciences (archeology) 1, Survival 1, Comms 0, Diplomat 0, Drive 0, Engineer 0, Informatics 0, Medic 0.

Common Traits (0-4): Eidetic Memory, Neural Jack, Subdermacomp  
Motivations: Spades.

Common DNAMs: Colonist Standard Package.

Comm, Portacomp, Med Kit, Sampling Kit, Hand Communicator, Uplink Communicator and all the assorted camping gear and surveying tools needed for a survey of a frontier world.

### Guard

This guard is typical of the better-trained corporate guards and not just a thug off the street. Although loyal to the corporation that employs them, they are not fanatics.

| Character | Career Path       | Str | Dex | End | Int | Edu | Soc |
|-----------|-------------------|-----|-----|-----|-----|-----|-----|
| Guard 1   | Army (infantry) 2 | 8   | 8   | 8   | 7   | 7   | 7   |

Gun Combat (slug pistol) 1, Gun Combat (slug rifle) 1, Melee (bludgeon) 1, Recon 1, Sensors 1, Athletics 0, Carouse 0, Computers 0, Drive 0, Heavy Weapons 0, Mechanic 0, Medic 0.

Common Traits (0-4): Coolness Under Fire, Fearless, Nightvision, Persistent Injury, Tough.

Motivations: Clubs.

Common DNAMs: Usually none.

Inertial Armour, Comm, Stunstick, SMG, Autopistol.

## Street Thugs

These are the basic goons who serve and protect the crime lords and form the bulk of urban gangs. They tend to be very loyal to their leader but do not trust their compatriots. They can also be used for corporate enforcers and bodyguards but lack the discipline of trained troops or guards.

| Character   | Career Path        | Str | Dex | End | Int | Edu | Soc |
|-------------|--------------------|-----|-----|-----|-----|-----|-----|
| Thug Leader | Rogue (enforcer) 2 | 9   | 8   | 7   | 6   | 5   | 5   |

Gun Combat (slug pistol) 1, Melee (blade) 1, Persuade 1, Recon 1, Streetwise 1, Athletics 0, Carouse 0, Deception 0, Informatics 0, Social Sciences 0, Stealth 0.

Common Traits (0-4): Addiction, Coolness Under Fire, Fast, Fearless, Hard to Kill, Manic, Neural Jack, Nightvision, Persistent Injury, Rapid Recovery, Tough, Vengeful.

Motivations: Clubs.

Common DNAMs: Usually none.

Autopistol, Dagger.

## Spaceport Worker

Throughout the many small and large spaceports of Human space, these workers will always be there, usually in the background, going about their jobs and duties. Most are loyal enough to their employer and their jobs, that they cannot be bribed save with huge amounts of money.

| Character | Career Path         | Str | Dex | End | Int | Edu | Soc |
|-----------|---------------------|-----|-----|-----|-----|-----|-----|
| Worker 1  | Frontier (worker) 2 | 7   | 7   | 8   | 7   | 7   | 7   |

Drive (wheeled) 1, Mechanic 1, Trade (port operations) 1, Computers 0, Engineer 0, Space Sciences 0.

Common Traits (0-4): Empath, Internal Map, Neural Jack, Nightvision, Persistent Injury.

Motivations: Hearts.

DNAMs: Colonist Standard Package,.

Link phone, overalls, safety gear

## Terrorists

Throughout Human space there are terrorists, groups who are trying to effect political change through violence and the threat of violence. ProVolution and Earth First are the two most prominent groups but there are dozens more.

| Character | Career Path                             | Str | Dex | End | Int | Edu | Soc |
|-----------|---|-----|-----|-----|-----|-----|-----|
| Terrorist | Army (infantry) 2<br>Rogue (enforcer) 1 | 8   | 7   | 8   | 7   | 7   | 6   |

Gun Combat (slug rifle) 2, Drive (wheeled) 1, Explosives 1, Melee (unarmed) 1, Persuade 1, Recon 1, Stealth 1, Streetwise 1, Athletics 0, Deception 0, Heavy Weapons 0, Informatics 0, Social Sciences 0.

Traits: Addiction, Bigoted, Persistent Injury, Tough, Vengeful.

Motivations: Clubs.

DNAMs: None

M-57 autopistol, AS-89 gauss rifle

## The Augmented Terrorist

ProVolution often makes use of cybernetically-augmented operatives. Add the following bionics/implants to the standard terrorist NPC:

Cybernetic right arm with concealed 9mm pistol

Supercharger (+Tough Trait)

Neural Sheathing (+Fast/2)

Cybernetic eye with lowlight option

Neural Jack

Implanted bio-laser in left arm

## SECTION 2: STARSHIP CREWS

This sections details the typical sorts of NPCs that are likely to be encountered aboard spacecraft, including military and pirates.

### Belters

Although not common, there are Belter communities throughout human space, however, the largest is still in the Sol system. Most Belters will be armed but the weapons will not be immediately obvious. They tend to be clannish and stick together.

| Character      | Career Path         | Str | Dex | End | Int | Edu | Soc |
|----------------|---------------------|-----|-----|-----|-----|-----|-----|
| Belter Captain | Wanderer (belter) 3 | 8   | 4   | 8   | 6   | 7   | 6   |

Gunnery, Pilot, Mechanic, Melee, Trade (belter) 2, Vacc Suit

Traits: Persistent Injury, Tough.

Motivations: Diamonds 6, Spades 4 Her curiosity serves her desire for wealth, driving her and her crew into distant reaches looking for that big strike

DNAMs: Microgravity

Skinsuit, shotgun, katana, neural jack, Thorez courier modified as mining vessel

### Pirates

Rare at the moment, these brigands of the spaceways are becoming more common, especially in the relatively lawless far reaches of the French Arm. Corsairs will try to capture vessels without bloodshed but are not above extreme violence if necessary.

| Character | Career Path            | Str | Dex | End | Int | Edu | Soc |
|-----------|------------------------|-----|-----|-----|-----|-----|-----|
| Pirate 1  | Rogue (Pirate) 3 terms | 9   | 11  | 9   | 10  | 9   | 7   |

Gunnery/1, Pilot/2, Mechani/1c, Melee/1, Vacc Suit,

Traits: Wanted/3, Tough/1, Common Sense/1.

Motivations: Clubs Jack, Diamonds 7 While charming, he is subject to the occasional murderous rage.

DNAMs: Microgravity

Civilian Vac Suit, SVB-1 laser rifle, wire knife,

### Merchant Crew

This represents a merchant crew on the ground; wary but not equipped to repel an attack. Merchants set to repel boarders will have light pressure suits and shotguns. Libertine crews in particular will stick together and be wary of strangers.

| Character | Career Path                  | Str | Dex | End | Int | Edu | Soc |
|-----------|------------------------------|-----|-----|-----|-----|-----|-----|
| Merchant  | Merchant (Libertine) 3 terms | 5   | 8   | 8   | 11  | 9   | 5   |

Engineer (Stutterwarp)/1, Pilot/1, Broker/1, zero-gee/0, mechanic/1, Melee/1

Traits: Fast/2.

Motivations: Diamonds 5, Hearts 4 Not just for love of money but for love of crew, will send this crewmember into any situation to lend a hand.

DNAMs: Microgravity

Skin Suit, wire knife

### SECTION 3: MILITARY

This section deals with some examples of members of organised military forces.

#### Combat Walker Pilot

Ectomorphs make excellent walker crews – their dexterity helps operate the vehicles precisely and their lack of muscle and durability do not matter so much when the walker can do the job with its mighty powered arms.

The term 'pilot' is traditional or sometimes 'operator'.

| Character  | Career Path           | Str | Dex | End | Int | Edu | Soc |
|------------|-----------------------|-----|-----|-----|-----|-----|-----|
| Operator 1 | Marine (Infantry) 0 3 | 7   | 10  | 8   | 8   | 9   | 7   |

Battledress/2, Drive (walker)/2, Drive (hover)/0, Heavy Weapons/1, Gun Combat/1, Pilot/2, Melee/0

Traits: Longevity/1, Fast/2.

Motivations: Clubs 7, Hearts 4 The operator recognises their violent streak and channels it into their control of their walker.

DNAMs: None

Civilian Vac Suit, SVB-1 aser rifle, wire knife,

#### Marine

A marine, primed for an assault into a hostile space vessel.

| Character | Career Path                  | Str | Dex | End | Int | Edu | Soc |
|-----------|------------------------------|-----|-----|-----|-----|-----|-----|
| Marine    | Marine (Star Marine) 3 terms | 11  | 8   | 8   | 7   | 6   | 8   |

Gun Combat/2, Recon/1, Heavy weapons/1, Zero-Gee/1, Streetwise/0, Drive (wheeled)/1, Medic/0

Traits: Robust/2, Heavy/1, Ally/1, Contact/1, Rival/1.

Motivations: Clubs 6, Hearts 5 Genuinely helpful and concerned, this trooper nonetheless will not hesitate to use violence when required.

DNAMs: Microgravity

Vacuum Combat Dress, A-9 Plasma Gun or SK-19 Assault Rifle

### Mercenary

At the top end of the spectrum is the elite mercenary, often in the long-term employ of a colonial government that is unwilling or unable to raise its own troops locally. Although often despised by regular citizens and colonial militias, the elite mercenary tends to live a fairly comfortable life.

| Character   | Career Path                           | Str | Dex | End | Int | Edu | Soc |
|-------------|---------------------------------------|-----|-----|-----|-----|-----|-----|
| Mercenary 1 | Civilian (Farmer) 1 Army (Infantry) 3 | 10  | 9   | 8   | 7   | 7   | 6   |

Gun Combat/3, Heavy Weapons/2, Recon/2, Drive (Walker)/1, Melee/3

Traits: Robust, Hard to Kill.

Motivations: Hearts 3 Clubs 6.

DNAMs: None

Inertial Armour, Vedette half-plate, helmet, FAM-90 Assault Rifle, long-range comm, HUD linked to sight on rifle

### Full-body CYBORG

| Name  | Str | Dex | End | Int | Edu | Soc |
|-------|-----|-----|-----|-----|-----|-----|
| Boris | 9   | 9   | 12  | 9   | 11  | 8   |

| Home Gravity | Normal | Body Type | Normal |
|--------------|--------|-----------|--------|
|--------------|--------|-----------|--------|

| Core/Frontier | Core | — | — |
|---------------|------|---|---|
|---------------|------|---|---|

| Augmentations | Upper and Lower Torso Replacement, genitalia, standard head, advanced arms and legs, low-light and telescopic vision, extended range hearing, extended olfactory senses, armor 12, subdermacomp, subdermalink |
|---------------|---|
|---------------|---|

| Age | 42 |
|-----|----|
|-----|----|

| Careers | Citizen (Freelancer) (1 term), Scholar (Scientist) (2 terms) Army (Infantry) (2 terms), Citizen (Freelancer) 1 term |
|---------|---|
|---------|---|

| Skills | Drive (Wheeled) 1, Computer 2, Gun combat (Rifle) 2, Admin 1, Art 1, Streetwise 1, Recon 2, Melee 1, Science 0, Athletics 1 |
|--------|---|
|--------|---|

| Equipment | Suit, — — — |
|-----------|-------------|
|-----------|-------------|

| Character | Despite the doctor's best efforts, Boris doesn't look human. If he stays still, he looks normal. But there |
|-----------|--|
|-----------|--|

| Motivation | Club 6, Joker Boris is a little crazy from all that has happened to him and is in danger of taking his new body and finding out how many people he can kill with it. Only an excessive amount of drugs keeps him under control. |
|------------|---|
|------------|---|

| Traits: | Constant Pain/Major, Tormented/Major, Dark Secret/Critical, Annoying Traits, Addiction |
|---------|--|
|---------|--|



Boris Chibik was a combat walker reserve operator in the Wellon Home Guard. In late 2297 he was flying back from a ship-board exercise in a Royal Space Navy Gyrfalcon dropship when it experienced a catastrophic hull failure during re-entry. Almost everyone on board was killed instantly but Boris had been inside a Bh-21 combat walker and survived re-entry by bailing out of the crumbling hulk in the walker.

The walker's parachute was damaged by the violent egress and Lieutenant Chibik fell 15 kilometres to the surface of Tirane

below. The crash gel that deployed inside the walker just before it hit managed to cushion Boris well enough that his central nervous system and a couple of organs survived. Furthermore, he had the good fortune to crash within 15 minutes of the most advanced hospital on Tirane. They were able to sustain what was left of him until a suitable cybernetic shell could be built. In early 2299, the remnants of his bio-system were implanted into the robotic body and he started the long process of learning how to walk and talk again.

## ANIMALS

In addition to the intelligent creatures of the 2300AD universe, there are a wide variety of animals to be found on the various worlds. What follows is only a small selection of the enormous biodiversity to be found throughout the colonies and outposts of Humanity.

### Horse

The horse is ubiquitous on new colonies, as a (more or less) self-repairing, self-replicating mode of transportation. Although they are often superseded by mechanised transport after a generation or so, rural areas still make use of them.

| Behaviour and Diet | Preferred Habitat | Movement Mode(s) | STR | DEX | END | INT | INS | PCK |
|--------------------|-------------------|------------------|-----|-----|-----|-----|-----|-----|
| Grazer, Herbivore  | Domestic          | Walker           | 12  | 7   | 15  | 3   | 3   | 5   |

|                  |  |
|------------------|--|
| <b>Size:</b>     | 9  |
| <b>Mass:</b>     | 600kg                                      |
| <b>Skills:</b>   | Survival: 3 Athletics: 2 (run)             |
| <b>Traits:</b>   | Acute sense (smell), Acute sense (hearing) |
| <b>Attacks:</b>  | Kick 1d6+2                                 |
| <b>Armour:</b>   | 0  |
| <b>Number</b>    | 1-6  |
| <b>Reaction:</b> | A10/F5                                     |

### Burrowvarg

This small, dog-like animal originally hails from Beta Canum but can be found on several worlds. The main issue with owning these animals is their different biochemistry, which means they require special food. They are generally not seen on worlds that cannot natively support them.

| Behaviour and Diet | Preferred Habitat | Movement Mode(s) | STR | DEX | END | INT | INS | PCK |
|--------------------|-------------------|------------------|-----|-----|-----|-----|-----|-----|
| Grazer, Herbivore  | Domestic          | Walker           | 15  | 7   | 15  | 3   | 3   | 5   |

|                  |  |
|------------------|--|
| <b>Mass:</b>     | 50kg                                       |
| <b>Skills:</b>   | Survival: 3 Athletics: 2 (run)             |
| <b>Traits:</b>   | Acute sense (smell), Acute sense (hearing) |
| <b>Attacks:</b>  | Bite 1d6                                   |
| <b>Armour:</b>   | 0  |
| <b>Number</b>    | 1-6  |
| <b>Reaction:</b> | A8/F3                                      |

**Size:** 4

As opposed to a neo-dog, this is standard large-breed dog, like a Rottweiler or German Shepherd, that is very common on frontier world as house-hold pets and guard animals.

| Behaviour and Diet | Preferred Habitat | Movement Mode(s) | STR | DEX | END | INT | INS | PCK |
|--------------------|-------------------|------------------|-----|-----|-----|-----|-----|-----|
| Chaser, Carnivore  | Domestic          | Walker           | 6   | 12  | 8   | 1   | 5   | 5   |

### Dog

|                  |  |
|------------------|--|
| <b>Size:</b>     | 5  |
| <b>Mass:</b>     | 60kg                                       |
| <b>Skills:</b>   | Survival: 3 Athletics: 2 (run)             |
| <b>Traits:</b>   | Acute sense (smell), Acute sense (hearing) |
| <b>Attacks:</b>  | Bite 1d6                                   |
| <b>Armour:</b>   | 0  |
| <b>Number</b>    | 1-6  |
| <b>Reaction:</b> | A8/F3                                      |

### White Wing

This large, winged predator from Hermes is feared and respected by the inhabitants of Hermes, its native world. Large and powerful, it is often the subject of hunts, both photographic and trophy. Sometimes the hunters do not return. The white wing will hunt day or night and can use its sonar to broadcast a tremendous, terrifying scream.

| Behaviour and Diet | Preferred Habitat | Movement Mode(s) | STR | DEX | END | INT | INS | PCK |
|--------------------|-------------------|------------------|-----|-----|-----|-----|-----|-----|
| Pouncer, Carnivore | Plains            | Flight           | 6   | 16  | 12  | 0   | 4   | 1   |

|                  |                                       |
|------------------|---------------------------------------|
| <b>Size:</b>     | 6                                     |
| <b>Mass:</b>     | 110kg                                 |
| <b>Skills:</b>   | Survival: 2 Athletics: 2 (fly)        |
| <b>Traits:</b>   | Echolocation/2, Fast/2, Flyer/2       |
| <b>Attacks:</b>  | Jaws 2d6, Claws 1d6, 2d6 (sonic fear) |
| <b>Armour:</b>   | 0                                     |
| <b>Number</b>    | 1                                     |
| <b>Reaction:</b> | A4/F12                                |



The sonic attack can paralyse exactly like a sonic stunner.

### Dragonbat

The Dragonbat is a large and deservedly feared predator of the mountainous regions of Beowulf. This fearless-flyer is capable of taking off with prey of up to 20 kilograms in its sharp claws and can kill or injure animals several times larger. At very close range, it can spit digestive acid, aiming for the eyes.

| Behaviour and Diet | Preferred Habitat | Movement Mode(s) | STR | DEX | END | INT | INS | PCK |
|--------------------|-------------------|------------------|-----|-----|-----|-----|-----|-----|
| Hunter, Carnivore  | Mountains         | Flyer            | 13  | 14  | 13  | 1   | 4   | 2   |

|                  |   |
|------------------|---|
| <b>Size:</b>     | 8   |
| <b>Mass:</b>     | 190kg                                     |
| <b>Skills:</b>   | Survival: 2 Athletics: 2 (fly), Melee/2   |
| <b>Traits:</b>   | Acute sense (vision), fast/1, flyer/3,    |
| <b>Attacks:</b>  | Kick 1d6+2, Acid 1d6 + special (blinding) |
| <b>Armour:</b>   | 2   |
| <b>Number</b>    | 1   |
| <b>Reaction:</b> | A4/F12                                    |



### Hummers (Pterodeimos var.)

A vicious plains-hunter native to Vogelheim (Adlerhorst), this flightless bird-analogue can reach speeds of up to 80 kilometres per hour in the open. It prefers to strike from concealment and quickly runs its prey down. Heavy rifles or handguns are required to take this creature down.

| Behaviour and Diet | Preferred Habitat      | Movement Mode(s) | STR | DEX | END | INT | INS | PCK |
|--------------------|------------------------|------------------|-----|-----|-----|-----|-----|-----|
| Chaser, Carnivore  | Forest, hill or plains | Walker           | 10  | 10  | 15  | 1   | 9   | 5   |

|                  |  |
|------------------|--|
| <b>Size:</b>     | 9  |
| <b>Mass:</b>     | 400kg  |
| <b>Skills:</b>   | Survival: 3 Athletics: 2 (run), Melee/2                  |
| <b>Traits:</b>   | Acute sense (vision), Acute sense (hearing), Nightvision |
| <b>Attacks:</b>  | Claws 1d6+2, Beak 1d6+1                                  |
| <b>Armour:</b>   | 0  |
| <b>Number</b>    | 1-6  |
| <b>Reaction:</b> | A4/F12   |

### Gatinnhos de Seva

A cunning and capable hunter, native to the Brazilian world of Paulo, the gatinnhos runs in packs, taking shifts as they chase down their prey, eventually falling upon the exhausted animal. They are also known to use some devious tactics, including ambush and surprise.

| Behaviour and Diet | Preferred Habitat | Movement Mode(s) | STR | DEX | END | INT | INS | PCK |
|--------------------|-------------------|------------------|-----|-----|-----|-----|-----|-----|
| Hunter, Carnivore  | Forest            | Walker           | 11  | 7   | 15  | 1   | 3   | 5   |

|                  |  |
|------------------|--|
| <b>Size:</b>     | 9  |
| <b>Mass:</b>     | 200kg                                      |
| <b>Skills:</b>   | Survival: 3 Athletics: 2 (run) Recon: 2    |
| <b>Traits:</b>   | Acute sense (smell), Acute sense (hearing) |
| <b>Attacks:</b>  | Bite 2d6                                   |
| <b>Armour:</b>   | 2 (Hide)                                   |
| <b>Number</b>    | 2-12                                       |
| <b>Reaction:</b> | A6/F4                                      |



### Zururyu ('Clever Dragon')

This lizard-like animal, native to Joi, may very well be on the verge of sentience. It is judged to be smarter than a terrestrial gorilla and some experts state that they have developed a language. Any Japanese colonist of Joi would attest to their intelligence, especially after a well-protected and fenced garden had been raided by a troop of these creatures. Oddly enough, they tend to leave the carefully tended Zen gardens alone. The Japanese often also refer to them as Chibigoji ('little Godzilla'), especially after one of their garden raids.

| Behaviour and Diet | Preferred Habitat | Movement Mode(s) | STR | DEX | END | INT | INS | PCK |
|--------------------|-------------------|------------------|-----|-----|-----|-----|-----|-----|
| Gatherer, Omnivore | Light Forest      | Walker           | 6   | 10  | 8   | 4   | 8   | 5   |

|                  |  |
|------------------|--|
| <b>Size:</b>     | 5  |
| <b>Mass:</b>     | 30kg   |
| <b>Skills:</b>   | Survival: 3 Athletics: 2 (run) Melee/1 Stealth/2 |
| <b>Traits:</b>   | Acute sense (hearing), Fast/2,                   |
| <b>Attacks:</b>  | Kick 1d6-1                                       |
| <b>Armour:</b>   | 0  |
| <b>Number</b>    | 3-18   |
| <b>Reaction:</b> | A10/F6   |



### Hellshark

This creature is the greatest fear of the scouting teams on Haifeng. A full-grown Hellshark is in excess of 100 metres long, with a gaping maw studded with two-metre-long teeth. The maw has two clusters of tentacles, one on either side, 8–12 per cluster depending on species, which grab prey and shove them into the maw to be torn apart by the teeth. Although there are larger creatures on Haifeng, none are as aggressive as the hellshark.

| Behaviour and Diet | Preferred Habitat | Movement Mode(s) | STR | DEX | END | INT | INS | PCK |
|--------------------|-------------------|------------------|-----|-----|-----|-----|-----|-----|
| Eater, Carnivore   | Deep Ocean        | Swimmer          | 52  | 10  | 60  | 0   | 3   | 5   |

|                  |  |
|------------------|--|
| <b>Size:</b>     | 11   |
| <b>Mass:</b>     | 500 tons                                   |
| <b>Skills:</b>   | Survival: 3 Athletics: 2 (run)             |
| <b>Traits:</b>   | Acute sense (smell), Acute sense (hearing) |
| <b>Attacks:</b>  | Tentacle slash 10d6, (x24), Bite 20d6      |
| <b>Armour:</b>   | 10 (Hide)                                  |
| <b>Number</b>    | 1-2  |
| <b>Reaction:</b> | A4/F12                                     |

### Neos

Neos are genetically-altered animals, created to serve as companions to humans on particularly hazardous colony worlds. There is considerable controversy surrounding neos, as they all have near-human-range intelligence, yet are effectively enslaved through bio-chemical imprinting. The North American Research League (NARL) has long campaigned for their production to be stopped. Oddly enough, the Life Foundation, usually an ardent support of the rights of living things, does not support banning the productions of neos, just of tighter controls over who can get one and improved monitoring of their living conditions.

### Dog

The neo-dog was created from German Shepherd stock. The alterations are subtle, mostly enhancing the animal's intelligence and sense of smell. A neo-dog can understand about 400 words and speak about 50–80. They can be trained far quicker than an unaugmented animal. They are designed to bond based on smell and a neo-dog is decanted with a specific person already imprinted.

| Behaviour and Diet | Preferred Habitat | Movement Mode(s) | STR | DEX | END | INT | INS | PCK |
|--------------------|-------------------|------------------|-----|-----|-----|-----|-----|-----|
| Chaser, Carnivore  | Domestic          | Walker           | 8   | 13  | 14  | 4   | 3   | 5   |

|                 |  |
|-----------------|--|
| <b>Size:</b>    | 9  |
| <b>Mass:</b>    | 55kg   |
| <b>Skills:</b>  | Survival: 3 Athletics: 2 (run) Recon 2 Melee 2 |
| <b>Traits:</b>  | Acute sense (smell), Acute sense (hearing)     |
| <b>Attacks:</b> | Bite 1d6+2                                     |
| <b>Armour:</b>  | 0  |
| <b>Number</b>   | 1  |

### Cats

Neo-cats are an extremely large creature, at least for a domestic cat and use the savannah cat as the base stock. Neo-cats are faster than their progenitors and as smart as a neo-dog, with similar linguistic skills. Like the neo-dog, they are bio-chemically imprinted for a specific individual during their creation.

| Behaviour and Diet | Preferred Habitat | Movement Mode(s) | STR | DEX | END | INT | INS | PCK |
|--------------------|-------------------|------------------|-----|-----|-----|-----|-----|-----|
| Pouncer, Carnivore | Domestic          | Walk             | 5   | 14  | 12  | 4   | 2   | 6   |

|                 |  |
|-----------------|--|
| <b>Size:</b>    | 5  |
| <b>Mass:</b>    | 30kg                                       |
| <b>Skills:</b>  | Survival: 3 Athletics: 2 (run)             |
| <b>Traits:</b>  | Acute sense (hearing), nightvision, Fast/1 |
| <b>Attacks:</b> | Bite 1d6                                   |
| <b>Armour:</b>  | 0  |
| <b>Number</b>   | 1  |

### Raven

Using the large northern raven as the base stock, the neo-raven is the fastest and one of the smartest, of the neos. It has the best speech capabilities of any of them. Many neo-ravens are fitted with cybernetic eyes that can transmit what it sees to their handler. When attacking, ravens will aim for the eyes and get a +2 DM on called shots to the eyes.

| Behaviour and Diet  | Preferred Habitat | Movement Mode(s) | STR | DEX | END | INT | INS | PCK |
|---------------------|-------------------|------------------|-----|-----|-----|-----|-----|-----|
| Hijacker, Carnivore | Domestic          | Flyer            | 3   | 9   | 4   | 5   | 3   | 5   |

|                 |   |
|-----------------|---|
| <b>Size:</b>    | 4   |
| <b>Mass:</b>    | 10kg                                      |
| <b>Skills:</b>  | Survival: 2 Athletics: 2 (fight), Recon 2 |
| <b>Traits:</b>  | Acute sense (vision), Flyer/2, Fast/2     |
| <b>Attacks:</b> | Peck 1d6/2, special                       |
| <b>Armour:</b>  | 0   |
| <b>Number</b>   | 1   |

### Octopus

Although unable to operate out of water, the neo-octopus has proven extremely useful, in large part for its ability to use tools underwater. Unlike the other neos, the octopus cannot speak, although it can understand as many words as the other varieties. Instead, the neo-octopus communicates through colour changes and pattern changes. Neo-octopuses are not biochemically bonded to their handlers but they seem to genuinely enjoy human company.

| Behaviour and Diet | Preferred Habitat | Movement Mode(s) | STR | DEX | END | INT | INS | PCK |
|--------------------|-------------------|------------------|-----|-----|-----|-----|-----|-----|
| Trapper, Carnivore | Domestic          | Swimmer          | 6   | 18  | 7   | 5   | 3   | 5   |

|                 |  |
|-----------------|--|
| <b>Size:</b>    | 5  |
| <b>Mass:</b>    | 20kg                                       |
| <b>Skills:</b>  | Survival: 3 Athletics: 2 (run) Stealth/3   |
| <b>Traits:</b>  | Acute sense (smell), Acute sense (hearing) |
| <b>Attacks:</b> | None                                       |
| <b>Armour:</b>  | 0  |
| <b>Number</b>   | 1  |

### Neo-fins

Neo-fins are dolphins trapped somewhere between their wild ancestors and the u-fins, not fully sapient but also no longer dumb animals. They are by far the smartest of the neos and have the most trouble adapting. Neo-fins are not biochemically-bonded to their handler. They lack the echo-location abilities of their wild kin and the u-fins.

| Behaviour and Diet | Preferred Habitat | Movement Mode(s) | STR | DEX | END | INT | INS | PCK |
|--------------------|-------------------|------------------|-----|-----|-----|-----|-----|-----|
| Grazer, Herbivore  | Domestic          | Swimmer          | 17  | 9   | 18  | 6   | 5   | 3   |

|                  |   |
|------------------|---|
| <b>Size:</b>     | 9   |
| <b>Mass:</b>     | 400kg                                       |
| <b>Skills:</b>   | Athletics (swim)/3, Recon/2, Survival/1     |
| <b>Traits:</b>   | Acute sense (smell), Acute sense (hearing), |
| <b>Attacks:</b>  | Ram 2d6, bite 1d6                           |
| <b>Armour:</b>   | 0   |
| <b>Number</b>    | 1-6   |
| <b>Reaction:</b> | A4/F12                                      |

## COLD MOUNTAIN

The ferocity of the native life on Han Shan (Cold Mountain) is legendary. The words for demon and animal have become interchangeable on that colony world. The Flying Blind is the best known of them, while the pseudo-shark ('p-shark') is the most dangerous.

### Flying Blinds

Flat, airborne creatures that resemble a Chinese kite or the slats from a Venetian blind; each 'blind' edge is razor sharp and they attack by swooping into prey edge-on. The 'blinds' are held together by a tether of edge material that snaps when the creature reproduces by splitting.

The following statistics are for an average-size creature. Smaller and much larger specimens have been noted.

| Behaviour and Diet | Preferred Habitat | Movement Mode(s) | STR | DEX | END | INT | INS | PCK |
|--------------------|-------------------|------------------|-----|-----|-----|-----|-----|-----|
| Killer, Carnivore  | Mountains         | Flyer            | 5   | 8   | 6   | 0   | 1   | 2   |

|                  |                     |
|------------------|---------------------|
| <b>Size:</b>     | 6                   |
| <b>Mass:</b>     | 40kg                |
| <b>Skills:</b>   | Survival: 3 Flyer:2 |
| <b>Traits:</b>   | Acute Sense (smell) |
| <b>Attacks:</b>  | Bladed slats 2d6+2  |
| <b>Armour:</b>   | 0                   |
| <b>Number</b>    | 1                   |
| <b>Reaction:</b> | A4/F10              |



### P-Shark

As bad as the blinds are, the p-shark is arguably worse. Another flyer, it is almost transparent until it feeds and very hard to see. It is a flying tube, with the interior lined with glass-like shards that it uses to cut up its prey and splash their fluids around on its interior. It attacks by diving down onto the target, aiming for the head if possible. How exactly a creature with apparently no more intelligence than a terrestrial jellyfish knows to aim for a human head is unknown.

| Behaviour and Diet | Preferred Habitat | Movement Mode(s) | STR | DEX | END | INT | INS | PCK |
|--------------------|-------------------|------------------|-----|-----|-----|-----|-----|-----|
| Eater, Carnivore   | Moun-tains        | Flyer            | 5   | 12  | 5   | 0   | 1   | 3   |

|                  |                      |
|------------------|----------------------|
| <b>Size:</b>     | 6                    |
| <b>Mass:</b>     | 55kg                 |
| <b>Skills:</b>   | Survival: 3 Plyer: 2 |
| <b>Traits:</b>   | Acute sense (smell)  |
| <b>Attacks:</b>  | Bladed Maw 3d6       |
| <b>Armour:</b>   | 0                    |
| <b>Number</b>    | 1-6                  |
| <b>Reaction:</b> | A4/F10               |

# 2300AD REFEREE'S GUIDE

This chapter provides some additional guidelines and ideas for *2300AD*, including sections on possible campaign types, goals and motivations and sources of conflict in the *2300AD* universe.

*2300AD* is a game of hard-science fiction in the not-too-distant future. This should be kept in mind as new adventures are being planned. There are no energy swords, giant robots or psionic madmen in the *2300AD* universe. A good source for inspiration for *2300AD* games is the day's news, which can provide plot hooks, atmosphere and ideas for many types of campaigns.

## CAMPAIGN TYPES

The universe of *2300AD*, although not as wide-open as the Imperium of *Traveller*, is still a vast amount of space and contains a large number of worlds to explore. In addition to the worlds already settled by humanity, there are alien home worlds, unexplored star systems and new worlds waiting to be explored.

Any theme can be explored as part of *2300AD* but there are several that define the game universe.

### **EXPLORATION AND ALIEN CONTACT**

The universe of *2300AD* is a big place and there is a great deal to discover. It is one of the key premises of the setting.

Exploration campaigns take a great deal of preparation. New systems have to be described and planned out, worlds mapped, alien societies and cultures created. With this sort of campaign there is a feeling of accomplishment at the end of a session, however. New wonders were revealed, new puzzles solved. These campaigns are less focused on action and more on adventure, so they require greater work to establish atmosphere and provide challenges.

There are a few areas of *2300AD* space ideal for an exploration-style campaign, including the Frontiers of the French Arm and the far end of the Chinese arm.

Examples of Exploration Adventures would include:

The characters are hired by an offshoot branch of the Academia del Lincei to travel to an uninhabited system on the Chinese Arm, where they suspect are some ancient Eber ruins on an airless world. The characters will have to search the system

for possible sites but at one of the moons of a gas giant their ground-search radar picks up the regular outlines of an artificial structure. It could be the ancient Eber base or perhaps a mining camp or possibly even a hidden pirate base.

The Transhuman League wants to sponsor an expedition to the abandoned outpost at Van Maanen's Star. They plan to survey the system with an eye to creating a colony of transhumanists, far from the prying eyes of the Earth nations and the research bans.

Freiland is a rare find, an inhabitable world just off the regular travel lanes in the Frontier of the French Arm. The warm, dark depths of the Grossitarge Senke are a perfect environment for discovery.

*Campaign Type:* Exploration

*Appropriate Characters:* Scouts, Academics, Mercenaries (guards), Professionals, Journalists

*Vehicles/Equipment:* Access to a ship, ground vehicle for exploration

*NPCs required:* Ship Crew, others as required to round out expedition staff

*Goals/Rewards:* Explore, find new life and new riches, mineral claims, money, adventure.

## GROUND COMBAT

Ground Combat in *2300AD* can involve low-intensity warfare against colonial rebels, high-intensity conflict against Kaefers or high-intensity combat versus other human nations. The first is the most common and has a great deal of opportunity for small-unit (mercenary) operations.

This kind of game is popular, as it has a great deal of action but it can become repetitive. It is wise to intersperse the combat with some other sort of action, like an investigation in barracks or other types of missions. Changing the enemy and the mission fairly often also helps to keep things fresh.

The *Traveller* Character Generation system assumes that all generated characters have mustered out of whatever service they were in and are now in the private sector. However, to have a military-based campaign, simply do not run the characters through the mustering-out process and keep them in service. They would be supplied with weapons and equipment as appropriate for their service branch and nationality. In-service cam-

paigns are quite easy to run, as the characters can simply be ordered to go somewhere and do something but the long lines of communication in *2300AD* mean that they will generally be given a great deal of leeway in how they accomplish their task.

### **Examples of Ground Military Adventures**

On the world of Heidelshemat, the Texan colony and the Heidelshemat colony are involved in a territorial dispute over the series of islands between the two, which, up until the discovery of oil, had been unclaimed by any group on the planet. Texas sees the oil as the solution for their over-extended economy and a way to make the colony pay for itself. In a similar vein, Heidelshemat sees the oil resources as key to their own survival and key to whether they accept German hegemony or declare independence. Both colonies are advancing their claims and Texas has begun active recruiting to beef up the limited number of Department of Public Safety troops currently available on the world. Heidelshemat has recently hired Manchurian mercenaries, along with their combat walkers and support equipment. Players could be hired on either side and war could be imminent.

Iran is always hiring mercenaries to patrol its more inhospitable regions and for special forces-type work. Iran is involved in a border dispute with Iraq, who has gone deep into debt to hire a cadre of French mercenaries, mostly armour and artillery. It looks like the border dispute might heat up, again.

*Campaign Type:* Ground Military

*Appropriate Characters:* Mercenaries, Professionals, Martial Artists, Engineers, Merchants, Medics, Travellers (Army or Marines if in service)

*Vehicles/Equipment:* Personal Weapons and armor, ground or air vehicle for transport

*NPCs required:* Support types, mercenaries to fill out unit

*Goals/Rewards:* Accomplish the mission and get paid. Often the action is another sort of reward. Payment is usually money, weapons, equipment or a combination of the three

*Complications:* Betrayed by employer, crisis of conscience (working for wrong side), facing overwhelming odds, poor equipment, clashing with 'allied' units

## **SPACE COMBAT**

Space combat enters a campaign in two different ways. In most campaigns, it will just be another sort of encounter, played through as the players journey to the real goal of the campaign. This type of space combat is best done with the basic space combat rules. In the Space Military campaign, however, space combat is the focus of the game. Players will be crew aboard a vessel or each player could take on the role of a ship's captain, commanding a vessel in an ongoing campaign.

This second type of campaign is more of a running war game and would require the Referee to come up with rules for resupply and repair. Note should be taken of traditional allies and rivals when deciding what nations will reprovision a ship. Typically, a colony



has to be at least Tech Level 11 (B) to repair military starships.

Note that just like under Ground Military, characters can still be in service at the start of play, even though the *Traveller* Character Generation system assumes otherwise.

### **Examples of space combat adventures**

A small group of pirates is preying on commercial shipping in the volume of space between Cold Mountain and Chengdu and Manchurian authorities have offered a bounty on the pirates.

A Manchurian vessel is attempting to run the French blockade at Joi in order to get weapons in to Elysia.

The American Space Force has decided to move in and clean up the pirates in and around a system near Ellis.

*Campaign Type:* Space Combat

*Appropriate Characters:* Navy, Mercenary, Scout, Rogue

*Vehicles/Equipment:* Armed starship, frigate-class or better

*NPCs required:* Fill-out crew positions, crew of other vessels, enemy crews and boarding parties

*Goals/Rewards:* Follow orders, protect civilian lives, money, career advancement, action

*Complications:* Betrayal, running out of ordnance, crew casualties, capture, hostile actions from other Human militaries



# TROUBLESHOOTING CAMPAIGNS

Troubleshooting campaigns often revolve around a combination of mystery and violence. Troubleshooters are hired to solve problems, often corporate in nature but troubleshooting adventures can encompass just about any sort of job. These problems can be professional in nature and involve underworld skills or just about anything. Usually set on a Frontier world, a troubleshooting game requires a strong mix of skills and abilities. Although troubleshooters can often draw on the resources of the nation, corporation or foundation that hired them, they still have to exercise discretion and be able to operate on their own resources if necessary.

## Examples of troubleshooting jobs

Parts are going missing at an orbital shipyard and outside consultants are brought in by the head office to investigate.

A corporation is having union troubles on a distant mining outpost and the investigators are brought in to get the dirt on the union leaders.

A Foundation is concerned by unusual reports coming in from a distant science outpost located on a sparsely-populated colony. The troubleshooters are hired to travel to the outpost and find out what, if anything, is going on.

## Campaign Type: Troubleshooting

*Appropriate Characters:* Agents, Citizens, Rogues, Scholars, Mercenaries, Scouts

*Vehicles/Equipment:* Surveillance and investigative equipment, personal weapons

*NPCs required:* Contacts, informants, opponents (including goons, guards, underlings and the mastermind)

*Goals/Rewards:* Solve the mystery, survive the mission, get paid the big bucks

*Complications:* Betrayal, lack of information, false information, lack of cooperation from locals

# TRADE AND COMMERCE

Although a staple of *Traveller*, the Trade and Commerce campaign is more difficult to implement for *2300AD*, as it is more marginal. Most of the larger shipping concerns are actually subsidised by the national governments, allowing them to turn a profit. Interface costs in particular are often partly or even wholly underwritten by governments.

Most Libertine traders do the larger portion of their business with orbital stations and asteroid bases, where interface costs are negligible to none.

## Examples of Merchant Adventures

Ferrying industrial equipment to and luxury foodstuffs from, a world like Montana in the Chinese Arm or Ellis in the American Arm.

The ship is carrying supplies to Aurore, including several tons of pay-dirt, used to create soil friendly to terran life-forms. The ship is also carrying a large amount of surplus military equipment for the Tanstaaf Colonial Militia and a number of more advanced weapons for the Tanstaaf Free Legion.

The characters are the crew aboard the Libertine transport *Star of Gabriel*, en route up the Chinese Arm to Paulo. Along the way it takes on passengers who are part of the Interstellar Circus, who got abandoned by the circus fleet when they ended up in jail after a particularly raucous and alcoholic, binge. The seven performers are a mixture of clowns and carnies and are liable to be quite the handful.

## Campaign Type: Trade and Commerce

*Appropriate Characters:* Agents, Citizens, Aristocrats, Rogues, Merchants, Scouts, Scholars

*Vehicles/Equipment:* Personal equipment, weapons and likely a small ship (Thorez would be appropriate)

*NPCs required:* Contacts, customers, NPCs as required to fill out crew positions

*Goals/Rewards:* Make the big deal, make lots of little deals, fuel the ship, keep flying

*Complications:* Market downturns, false information, ship troubles, mutiny, hijacking

# COUNTERTERRORIST

The counterterrorist game is a hard, dark game to play, as it delves into the ultra-violent world of *2300AD* terrorism, with its unwilling cyborgs and casual disregard for human life. The terrorists of *2300AD* are advocates of a variety of causes, from ultra-environmentalists to nihilistic religious cults, ProVolution and its augmented agents, to the Children of Mao and their knives. All share the common characteristic of being utterly devoted to their cause and the belief that their way is the best thing for Humanity.

Counterterrorist operations are not just concerned with killing terrorists. The individual terrorists are not as dangerous as the support networks that these organisations create and the primary goal of counter-terrorist operations is the discovery and neutralisation of these networks.

## Examples of Counterterrorist adventures

ProVolution has announced that they have let loose a walking nuclear bomb in Tokyo. Authorities have 12 hours to find the bomb and neutralise it or else a 100 kiloton device will go off somewhere in Tokyo. The carrier of the bomb is not even aware of his situation. ProVolution kidnapped him off the street, drugged him, implanted the device and then turned him loose.

Terrorists have taken hostages at the offices of the Trilon corporation and are demanding the usual (freedom of prisoners, withdrawal of troops) but no one knows who exactly they are. This adventure could go two ways: Investigate the group or go in and try to take them down. Investigation will reveal that the

group in question does not exist and are simply being used as a blind to confuse the authorities while the 'terrorists' (actually spies for a rival firm) go through Trilon's files and vaults and steal whatever they can.

ProVolution has seized a spaceplane, grabbing it just before takeoff. They managed to get implanted weapons through the spaceport's security grid and are now threatening to kill a hostage every hour until their demands are met. They want the American and Canadian governments to release all records on the King DNA modification project, which are still sealed even after more than 100 years.

*Campaign Type:* Counterterrorist

*Appropriate Characters:* Agents, Rogues, Mercenaries, Scouts, Active Service Military

*Vehicles/Equipment:* Surveillance and investigative equipment, personal weapons

*NPCs required:* Contacts, informants, opponents

*Goals/Rewards:* Find the terrorists, rescue the hostages, get information on terrorist group, survive an ambush

*Complications:* Betrayal, lack of information, false information, lack of cooperation from locals, hostages, booby-traps, unwitting cyborgs with implanted bombs and other weapons.

## CHARACTER GOALS AND MOTIVATIONS

### **SOURCES OF CONFLICT IN 2300AD**

There are several general themes of conflict in the 2300AD universe, all of which can be used as underlying basis for many adventures:

#### **CORE vs. FRONTIER**

The Frontier challenges the Core, with the oft-repeated charge that the Core is out of touch with the rapidly changing events on the Frontier. Often the goals of the Core-based governments, Foundations and corporations are at odds with the reality on the Frontier. At the same time, the Frontier does not realise what a balancing act maintaining the extra-solar colonies is, as the Core worlds have to allocate a limited tax base not only to the population at home, where the majority of the votes come from but also a disproportionate amount which goes to maintaining the colonies. Recent opinion polls in many of the colonising nations reflect a growing disillusionment with colonies and a desire to see the colonies pay more of their own way.

#### **ORGANISATIONS vs. INDEPENDENTS**

There are many organisations in 2300AD that strive to exert control over individuals, colonies and nations. Foremost of these are the various nations themselves. Although their influence is waning in the face of the other organisations, nations still maintain the lion's share of power in 2300AD and their citizens are subject to the exercise of that power, whether for good or ill. Foundations are another level of organisation, usually devoted

to fulfilling a national agenda but becoming ever more independent and increasingly focused on their own goals. Finally, as a counter-balance to national control, we have the multi-national corporations, which are becoming as powerful as nations and, in the case of Trilon and a few others, have actually become independent nations in their own right.

All of these groups seek the attention and loyalty of others and seek to exert control over people for the purpose of fulfilling their goals. For many people, this is exactly what they want, a place to belong. For others, however, the reality is different. They do not fit in and, largely, do not want to. These independents resist the encroachment of the establishment onto their turf, often forcibly.

#### **HUMAN vs. ALIENS**

This is not necessarily active conflict but the interests of Humans and the various alien races often clash. Individual aliens may or may not share their race's overarching goals but it is rare to find one that will advance humanity's goals ahead of their own race. Examples of the issues facing Human-Alien interaction include:

**Pentapod Factionalism:** There are many factions in Pentapod society, most of which do not work well together. There are, however, several axes in Pentapod society that the various factions tend to align themselves with. The pro-humans are in favour of continued good relations with humanity. Anti-humans favour, at the very least, breaking off contact with humanity and include those factions who favour using Pentapod biotechnology to 're-make' humans into a more useful form. The majority of Pentapod factions are neutral, with little interest in humanity at all.

**Sung Demands under Sos-Soon-Atkacharr:** Although the Slaver War ended over 40 years ago, the Sung still have not been brought up to as advanced a level as they feel they are entitled to under the provisions of the treaties signed with Human forces and by the rules governing conduct under Sos-Soon-Atkacharr. They have begun to agitate for an increased rate of technology transfers, while at the same time protesting over how little humanity has made them work for their new benefits.

**The Kaefers:** The level of threat they represent is unknown but the very existence of an advanced and hostile alien race is a threat that must be taken seriously. Unfortunately, the great distance and communications lag involved in communicating with Aurore has hampered human efforts.

#### **TRANSHUMANISTS vs. 'NORMALS'**

ProVolution is simply the violent end of the spectrum, which encompasses the so-called TransHumanists. They believe that humanity now has the tools to overcome its limitations and they want to make use of these tools. Cybernetics, genetics, DNA modification and artificial intelligence are all seen as enabling technologies and the TransHumanists want to see restrictions on these technologies lifted and new research initiated.

The majority of people are afraid of the TransHumanist ideals and of the idea that humanity can (or should) be transformed by these

technologies. Most simply do not want to be made obsolete and oppose the lifting of restrictions. Most of the TransHumanists protest peaceably and make their plans and grandiose predictions, while some few plot to bring down the old order and remake it in their favour. TransHumanists have a tendency to embrace new technologies and many have cybernetics or implants of some kind, even illegal implants, although usually not weapons.

Of any major extra-governmental organisation, the Life Foundation in particular seems to attract many TransHumanists.

## **NATIONAL RIVALRIES**

National rivalries and conflicts continue to dominate Human affairs. The current war between Argentina and Brazil is a good (and long-running) example of this. The many nations of Earth still struggle for dominance and the practice of dividing up the nations into Tiers further exacerbates the conflicts, as Tier 3 and Tier 4 nations struggle to prove that they are better than their ranking suggests. The national rivalries listed in the Background chapter (beginning on page 5) form a good starting point but any world shared by two or more nations can often spark a struggle. Witness the escalating tensions on Heildelsheimat between the Bavarian and Texan colonists over mineral resources or on Beowulf between the French and the British over fishing rights or even between the Australians and Japanese on Tirane over disputed borders. National conflict appears to be inevitable.

## **GOALS AND MOTIVATIONS**

It is important to keep goals and motivations in mind when designing adventures. Both the goals of the characters and the goals of the players are important. Why are they playing the game? What do they want to get out of it? As for characters, why are they doing what they are doing? What do they want to accomplish?

Similarly, the goals of the characters are up to each player. Goals should be clearly defined before the game begins, if possible and can be something as complex as 'find the ship that killed my family when I was a child, find the captain and bring him to justice' or as simple as 'fuel the ship, protect the crew and keep flying'. Character goals and motivations should have an effect on the campaign and even if they do not direct the overall story, they should direct the day-to-day actions of the crew. A Referee can use these goals to motivate the characters (and players) by crafting adventures that play to these goals, even if the end result is different.

## **BIBLIOGRAPHY**

### **2300AD Bibliography**

#### *Main Rules*

Traveller: 2300 boxed set

2300AD boxed set

#### *Sourcebooks*

Kaefer Sourcebook

Aurore Sourcebook  
Nyotekundu Sourcebook  
Ground Vehicle Guide  
Ships of the French Arm  
Colonial Atlas  
Earth/Cybertech Sourcebook

#### *Adventures*

Ranger  
Beanstalk  
Energy Curve  
Kaefer Dawn  
Rotten to the Core  
Deathwatch Program  
Bayern  
Operation Overlord (produced under license by 3W Games)

#### *Campaigns*

Invasion

#### *Games*

Star Cruiser

## **OTHER SOURCES:**

The following books, movies, TV shows, anime, manga and comics all have elements or ideas that fit the 2300AD universe. They are not all equal in quality and some serve solely to provide a visual reference for in-game atmosphere and descriptions. The presence of anything on this list should not be taken as an endorsement of the quality of the media in question, simply that it contains potentially useful ideas or visual depictions for 2300AD. This applies in particular to the various movies and TV shows referenced.

#### **Fiction**

*Clarke County, Space*, Alan Steele

*Lunar Descent*, Alan Steele

*Orbital Decay*, Alan Steele

*Downbelow Station*, CJ Cherryh

*Rimrunners*, CJ Cherryh

*Heavy Time*, CJ Cherryh

*Hellburner*, CJ Cherryh

*Revelation Space*, Alistair Reynolds

*Absolution Gap*, Alistair Reynolds

*Redemption Ark*, Alistair Reynolds

*Chasm City*, Alistair Reynolds

*Snow Crash*, Neal Stephenson

*Diamond Age*, Neal Stephenson (for a nanotech future)

*Cold As Ice*, Charles Sheffield

*Summertide*, Charles Sheffield

*When Gravity Fails*, Alex George Effinger  
*A Fire in the Sun*, Alex George Effinger

*Hammer's Slammers* series, David Drake

*Aristoi*, Walter John Williams (for a very nano-tech, virtual reality world)

*Hardwired*, Walter John Williams  
*Voice of the Whirlwind*, Walter John Williams  
*Angel Station*, Walter John Williams

*Rendezvous with Rama*, Arthur C. Clarke  
*Fountains of Paradise*, Arthur C. Clarke  
*Imperial Earth*, Arthur C. Clarke  
*Songs of Distant Earth*, Arthur C. Clarke

*The Moon is a Harsh Mistress*, Robert A. Heinlein  
*Starship Troopers*, Robert A. Heinlein

*The Real Story: The Gap into Conflict*, Stephen R. Donaldson  
*Forbidden Knowledge: The Gap into Vision*, Stephen R. Donaldson  
*Dark and Hungry God Arises: The Gap into Power*, Stephen R. Donaldson  
*Chaos and Order: The Gap into Madness*, Stephen R. Donaldson  
*This Day All Gods Die: The Gap into Ruin*, Stephen R. Donaldson

*Space Doctor*, Lee Corey

*The Legacy of Heorot*, Jerry Pournelle, Larry Niven and Stephen Barnes  
*The Dragons of Heorot*, Jerry Pournelle, Larry Niven and Stephen Barnes  
*Beowulf's Children*, Jerry Pournelle, Larry Niven and Stephen Barnes

*A Mote in God's Eye*, Jerry Pournelle and Larry Niven  
*The Gripping Hand*, Jerry Pournelle and Larry Niven

*West of Honor*, Jerry Pournelle  
*The Mercenary*, Jerry Pournelle  
*Prince of Mercenaries*, Jerry Pournelle  
*Falkenberg's Legion*, Jerry Pournelle  
*Go Tell the Spartans*, Jerry Pournelle and S.M. Stirling  
*Prince of Sparta*, Jerry Pournelle and S.M. Stirling

*Little Fuzzy*, H. Beam Piper  
*Fuzzy Sapiens*, H. Beam Piper  
*Four Day Planet*, H. Beam Piper  
*Naudsonce*, H. Beam Piper

*The Wild World of the Future*, Claire Pye

## **Comics and Manga**

*2001 Nights*  
*Planetes*  
*Ghost in the Shell*  
*Appleseed*  
*Aliens vs. Predator* (the comic, not the movie)  
*Erma Felna, EDF* (from Albedo Anthropomorphics) (Hard SF war story, with fuzzy animals...)

## **Reference**

Oxford Concise Science Dictionary  
Collins French-English/English-French Dictionary  
CIA World Fact Book

## **Filmography**

### **Movies**

*Avatar*  
*Outland*  
*2001*  
*2010*  
*Alien*  
*Aliens*  
*Alien 3*  
*Enemy Mine*  
*Gunhed* (if you ignore the giant robot toys)  
*Supernova* (Really just the ship...)  
*Moon 44*  
*Pitch Black*  
*Blade Runner*  
*Soldier*  
*Predator*  
*Predators*  
*Silent Running*  
*Starship Troopers*  
*Wing Commander*  
*Gattaca*  
*eXistenZ*  
*Solaris* (original Russian version)  
*Mission to Mars* (Ignore the end and the rest was OK)  
*Red Planet* (The look, the pressure suits. Not the story)  
*Total Recall*  
*Serenity*  
*Moon*

### **Television**

*Firefly* (If you ignore the artificial gravity and anti-gravity, this is very 2300AD)  
*Babylon 5*  
*Earth 2*  
*Space: Above and Beyond* (Chigs = Kaefers)  
*Battlestar Galactica* (New Series)  
*Alien Planet*  
*Outcasts*

### **Anime**

*Ghost in the Shell* (1 and 2)  
*Ghost in the Shell: Standalone Complex*  
*Wings of Honneimaise*  
*Cowboy Bebop*  
*Gundam* (more for the life-in-habitats ideas than the giant robot)  
*Appleseed* (the new one)

### **Video Games**

*Halo* and sequels  
*Aliens vs. Predator*  
*Killzone* series  
*System Shock 1 and 2*  
*Red Faction* series  
*Deus Ex* series

## Calendar 2300AD

### January

| S  | M  | T  | W  | T  | F  | S  |
|----|----|----|----|----|----|----|
|    | 1  | 2  | 3  | 4  | 5  | 6  |
| 7  | 8  | 9  | 10 | 11 | 12 | 13 |
| 14 | 15 | 16 | 17 | 18 | 19 | 20 |
| 21 | 22 | 23 | 24 | 25 | 26 | 27 |
| 28 | 29 | 30 | 31 |    |    |    |

### February

| S  | M  | T  | W  | T  | F  | S  |
|----|----|----|----|----|----|----|
|    |    |    |    | 1  | 2  | 3  |
| 4  | 5  | 6  | 7  | 8  | 9  | 10 |
| 11 | 12 | 13 | 14 | 15 | 16 | 17 |
| 18 | 19 | 20 | 21 | 22 | 23 | 24 |
| 25 | 26 | 27 | 28 |    |    |    |

### March

| S  | M  | T  | W  | T  | F  | S  |
|----|----|----|----|----|----|----|
|    |    |    |    | 1  | 2  | 3  |
| 4  | 5  | 6  | 7  | 8  | 9  | 10 |
| 11 | 12 | 13 | 14 | 15 | 16 | 17 |
| 18 | 19 | 20 | 21 | 22 | 23 | 24 |
| 25 | 26 | 27 | 28 | 29 | 30 | 31 |

### April

| S  | M  | T  | W  | T  | F  | S  |
|----|----|----|----|----|----|----|
| 1  | 2  | 3  | 4  | 5  | 6  | 7  |
| 8  | 9  | 10 | 11 | 12 | 13 | 14 |
| 15 | 16 | 17 | 18 | 19 | 20 | 21 |
| 22 | 23 | 24 | 25 | 26 | 27 | 28 |
| 29 | 30 |    |    |    |    |    |

### May

| S  | M  | T  | W  | T  | F  | S  |
|----|----|----|----|----|----|----|
|    |    | 1  | 2  | 3  | 4  | 5  |
| 6  | 7  | 8  | 9  | 10 | 11 | 12 |
| 13 | 14 | 15 | 16 | 17 | 18 | 19 |
| 20 | 21 | 22 | 23 | 24 | 25 | 26 |
| 27 | 28 | 29 | 30 | 31 |    |    |

### June

| S  | M  | T  | W  | T  | F  | S  |
|----|----|----|----|----|----|----|
|    |    |    |    |    | 1  | 2  |
| 3  | 4  | 5  | 6  | 7  | 8  | 9  |
| 10 | 11 | 12 | 13 | 14 | 15 | 16 |
| 17 | 18 | 19 | 20 | 21 | 22 | 23 |
| 24 | 25 | 26 | 27 | 28 | 29 | 30 |

### July

| S  | M  | T  | W  | T  | F  | S  |
|----|----|----|----|----|----|----|
| 1  | 2  | 3  | 4  | 5  | 6  | 7  |
| 8  | 9  | 10 | 11 | 12 | 13 | 14 |
| 15 | 16 | 17 | 18 | 19 | 20 | 21 |
| 22 | 23 | 24 | 25 | 26 | 27 | 28 |
| 29 | 30 | 31 |    |    |    |    |

### August

| S  | M  | T  | W  | T  | F  | S  |
|----|----|----|----|----|----|----|
|    |    |    | 1  | 2  | 3  | 4  |
| 5  | 6  | 7  | 8  | 9  | 10 | 11 |
| 12 | 13 | 14 | 15 | 16 | 17 | 18 |
| 19 | 20 | 21 | 22 | 23 | 24 | 25 |
| 26 | 27 | 28 | 29 | 30 | 31 |    |

### September

| S  | M  | T  | W  | T  | F  | S  |
|----|----|----|----|----|----|----|
|    |    |    |    |    |    | 1  |
| 2  | 3  | 4  | 5  | 6  | 7  | 8  |
| 9  | 10 | 11 | 12 | 13 | 14 | 15 |
| 16 | 17 | 18 | 19 | 20 | 21 | 22 |
| 23 | 24 | 25 | 26 | 27 | 28 | 29 |
| 30 |    |    |    |    |    |    |

### October

| S  | M  | T  | W  | T  | F  | S  |
|----|----|----|----|----|----|----|
|    | 1  | 2  | 3  | 4  | 5  | 6  |
| 7  | 8  | 9  | 10 | 11 | 12 | 13 |
| 14 | 15 | 16 | 17 | 18 | 19 | 20 |
| 21 | 22 | 23 | 24 | 25 | 26 | 27 |
| 28 | 29 | 30 | 31 |    |    |    |

### November

| S  | M  | T  | W  | T  | F  | S  |
|----|----|----|----|----|----|----|
|    |    |    |    | 1  | 2  | 3  |
| 4  | 5  | 6  | 7  | 8  | 9  | 10 |
| 11 | 12 | 13 | 14 | 15 | 16 | 17 |
| 18 | 19 | 20 | 21 | 22 | 23 | 24 |
| 25 | 26 | 27 | 28 | 29 | 30 |    |

### December

| S  | M  | T  | W  | T  | F  | S  |
|----|----|----|----|----|----|----|
|    |    |    |    |    | 1  | 2  |
| 3  | 4  | 5  | 6  | 7  | 8  | 9  |
| 10 | 11 | 12 | 13 | 14 | 15 | 16 |
| 17 | 18 | 19 | 20 | 21 | 22 | 23 |
| 24 | 25 | 26 | 27 | 28 | 29 | 30 |

#### Holidays of Note

|                                |         |
|--------------------------------|---------|
| New Year's Day                 | Jan 1   |
| Unity Day (Ukraine)            | Jan 22  |
| Australia Day                  | Jan 26  |
| Carnival Monday (Brazil)       | Feb 9   |
| Chinese New Year               | Feb 10  |
| President's Birthday (America) | Feb 16  |
| Alamo Day (Texas)              | Mar 6   |
| Easter Sunday                  | Mar 20  |
| Freedom Day (Azania)           | Apr 27  |
| Independence Day (Freihafen)   | May 23  |
| Dominion Day (Wellon)          | June 14 |
| Colony Days (America)          | June 27 |
| Canada Day                     | July 1  |
| Independence Day (America)     | July 4  |
| Independence Day (Texas)       | July 4  |
| Colony Days (Europe)           | July 8  |
| Independence Day (Argentina)   | July 9  |

#### Holidays of Note

|                                    |         |
|------------------------------------|---------|
| Bastille Day (France)              | July 14 |
| Throne Day (France)                | Aug 12  |
| General San Martin Day (Argentina) | Aug 20  |
| Independence Day (Ukraine)         | Aug 24  |
| Labor Day                          | Sept 3  |
| Independence Day (Brazil)          | Sept 7  |
| Independence Day (Mexico)          | Sept 16 |
| Ascension Day (Manchuria)          | Sept 21 |
| Heritage Day (Azania)              | Sept 24 |
| Reunification Day (Germany)        | Oct 3   |
| Founding (Heidelsheimet)           | Oct 21  |
| Independence Day (Germany)         | Dec 7   |
| Guy Fawkes Day (UK)                | Nov 5   |
| Twilight Remembrance Day           | Nov 11  |
| Louis Riel Day (Canada)            | Nov 16  |
| Revolution Day (Mexico)            | Nov 20  |
| Christmas                          | Dec 25  |

# NEAR STAR LIST

| 2300AD<br>Near Star<br>List |     |       |                     |             |               |           |        |
|-----------------------------|-----|-------|---------------------|-------------|---------------|-----------|--------|
| x                           | y   | z     | Catalog Name        | Common Name | Spectral Type | Magnitude | Number |
| 0                           | 0   | 0     | (SOL)               |             | g1v           | 4.67      | 0      |
| 11.4                        | 0.1 | -8.9  | DM-37 15492         |             | m4v           | 10.39     | 1      |
| 24.3                        | 0.2 | 24.7  | DM+44 4548          |             | m2v           | 9.76      | 2      |
| 24.5                        | 0.3 | 25    | DM+45 4408 A        |             | k9v           | 8.8       | 4      |
| 24.5                        | 0.3 | 25    | DM+45 4408 B        |             | m0v           | 13        | 4      |
| 24.5                        | 0.3 | 25    | DM+45 4408 C        |             | m0v           | 8.84      | 4      |
| 39.1                        | 0.6 | 21.4  | DM+28 4704          |             | k0v           | 5.46      | 5      |
| 25.5                        | 0.7 | 42.2  | Beta Cassiopei A    | Chaph       | f2iv          | 1.37      | 8      |
| 25.5                        | 0.7 | 42.2  | Beta Cassiopei B    |             | m0v           | 13        | 8      |
| 35.9                        | 2   | 8.5   | L1154 29            |             | m5v           | 13.5      | 12     |
| 35.2                        | 2.2 | 30.3  | DM+40 45            |             | m0v           | 8.3       | 14     |
| 8.1                         | 0.5 | 7.8   | Groombridge<br>34 A |             | m1v           | 10.32     | 15     |
| 8.3                         | 0.5 | 7.9   | Groombridge<br>34 B |             | m0v           | 13        | 15     |
| 8.3                         | 0.5 | 7.9   | Groombridge<br>34 C |             | m6v           | 13.29     | 15     |
| 9.7                         | 0.7 | -21.2 | Zeta Tucanae        |             | g2v           | 4.96      | 17     |
| 4.4                         | 0.4 | -20.1 | Beta Hydri          |             | g1iv          | 3.8       | 19     |
| 13.1                        | 1.6 | 31.2  | DM+66 34 A          |             | m2v           | 10.42     | 22     |
| 13.1                        | 1.6 | 31.2  | DM+66 34 B          |             | m4v           | 12.3      | 22     |
| 39.4                        | 6   | -18.7 | DM-25 225 A         |             | g5v           | 5.7       | 25     |
| 39.4                        | 6   | -18.7 | DM-25 225 B         |             | m0v           | 5.7       | 25     |
| 34.7                        | 5.5 | 20.5  | Wolf 1056           |             | m4v           | 10.54     | 26     |
| 31.6                        | 5.1 | 12.2  | DM+20 85            |             | k0v           | 5.75      | 27     |
| 34.2                        | 5.7 | 29    | DM+39 154           |             | k2v           | 6.6       | 28     |
| 32.4                        | 6.2 | -30   | DM-42 249A          |             | k5v           | 7.8       | 32     |
| 31.6                        | 6   | -29.2 | DM-42 249B          |             | m0vi          | 8.3       | 32     |
| 22                          | 4.4 | 1.9   | DM+4 123            |             | k2v           | 6.55      | 33     |

|      |      |       |                   |        |       |       |      |
|------|------|-------|-------------------|--------|-------|-------|------|
| 10   | 2    | 16.1  | Eta Cassiopei A   | Achird | g0v   | 4.6   | 34   |
| 10   | 2    | 16.1  | Eta Cassiopei B   |        | m0v   | 8.66  | 34   |
| 13.3 | 2.7  | 1.2   | Van Maanens Star  |        | g1vii | 14.26 | 35   |
| 43.7 | 9.5  | -19.2 | DM-23 332         |        | m0v   | 8.06  | 40   |
| 39.1 | 8.7  | -23.8 | DM-31 325 A       |        | k3v   | 6.4   | 42   |
| 39.1 | 8.7  | -23.8 | DM-31 325 B       |        | m0v   | 13    | 42   |
| 45.2 | 11   | -1.7  | DM-2 129          |        | k1vii | 8.3   | 44   |
| 19   | 4.9  | 35.6  | AC+60 3496        |        | m2v   | 10.2  | 47   |
| 7.9  | 2    | 24.3  | AC+71 532         |        | m3v   | 10.34 | 48   |
| 13.7 | 3.6  | 26.9  | DM+61 195 A       |        | m2v   | 9.72  | 49   |
| 13.7 | 3.6  | 26.9  | DM+61 195 B       |        | m0v   | 13    | 49   |
| 13.7 | 3.6  | 26.9  | Wolf 47           |        | m7v   | 13.81 | 51   |
| 19.3 | 5.5  | 40.5  | DM+63 137         |        | k7v   | 8.29  | 52   |
| 13.9 | 4    | 20.4  | Mu Cassiopei A    | Marfak | g5vi  | 5.75  | 53   |
| 13.9 | 4    | 20.4  | Mu Cassiopei B    |        | m8v   | 8.75  | 53   |
| 31.8 | 9.6  | 29.7  | DM+41 219         |        | f8v   | 4.2   | 53.4 |
| 10.4 | 3.2  | -26.7 | DM-68 47          |        | k0vii | 11.5  | 54   |
| 20.4 | 6.3  | -6.7  | L724 32           |        | m5v   | 12.4  | 54.1 |
| 29.5 | 9.7  | -32.1 | Nu Phoenicis      |        | f8v   | 4.2   | 55   |
| 43.6 | 14.8 | -13.1 | DM-16 214         |        | k3vii | 8.8   | 56   |
| 18.7 | 7.9  | 39.7  | DM+62 274         |        | k1v   | 6.1   | 59.3 |
| 18.6 | 8.2  | 31.2  | AC+56 13511       |        | m4v   | 11.4  | 63   |
| 37.5 | 16.6 | -3.8  | L870 2            |        | a0vii | 12.3  | 64   |
| 7.6  | 3.4  | -2.8  | UV Ceti           |        | m5v   | 15.8  | 65   |
| 30.8 | 13.9 | -36   | DM-47 502         |        | m0v   | 10    | 65.2 |
| 10.7 | 4.8  | -17.8 | Rho Eridani       |        | k2v   | 6.67  | 66   |
| 10.7 | 4.8  | -17.8 | DM-56 328         |        | k5v   | 6.83  | 66   |
| 25.1 | 11.5 | 25.2  | DM-41 328         |        | g2v   | 4.66  | 67   |
| 20.7 | 9.6  | 8.3   | DM+19 279         |        | k1v   | 5.88  | 68   |
| 17.5 | 8.1  | 38.9  | DM+63 229         |        | k5v   | 7.78  | 69   |
| 30   | 14.1 | 2.3   | AC+3 2259-31      |        | m2v   | 10.9  | 70   |
| 10.1 | 4.8  | -3.3  | Tau Ceti          |        | g8v   | 5.72  | 71   |
| 11.4 | 5.5  | 25.6  | DM+63 238         |        | k0v   | 5.91  | 75   |
| 32.2 | 16.6 | -7.1  | Ross 555          |        | m4vi  | 10.9  | 78   |
| 29.2 | 15.3 | -13.9 | DM-23 693         |        | m1v   | 8.6   | 79   |
| 18.2 | 10.1 | 33.8  | AC+58 13565       |        | m4v   | 11.7  | 82   |
| 19.4 | 10.9 | -41.7 | Alpha Hydri       |        | f0v   | 2.9   | 83   |
| 13   | 7.3  | 3.3   | L 1159-16         |        | m8v   | 13.91 | 83.1 |
| 13.4 | 7.6  | 28.6  | DM+61 366         |        | k5v   | 7.4   | 83.3 |
| 23.4 | 13.8 | -8.8  | DM-18 359         |        | m3v   | 10.46 | 84   |
| 16.5 | 10.1 | -45.5 | L89 27            |        | m0v   | 12.6  | 85   |
| 19.4 | 12.2 | -28.5 | DM-51 532         |        | k0v   | 5.86  | 86   |
| 31.5 | 19.7 | -20.2 | DM-28 694         |        | k2v   | 6.5   | 86.1 |
| 27.4 | 17.4 | 1.9   | DM+2 348          |        | m3v   | 10.03 | 87   |
| 20.8 | 13.4 | -15.7 | DM+32 828         |        | m0v   | 10.4  | 91   |
| 23.2 | 15.3 | 18.7  | Delta Trianguli A |        | g0v   | 4.8   | 92   |
| 23.2 | 15.3 | 18.7  | Delta Trianguli B |        | m0v   | 13    | 92   |
| 21.3 | 14.3 | -35.8 | DM-54 487         |        | m0v   | 12    | 93   |
| 35   | 23.8 | -20.9 | DM-26 828         |        | g5v   | 5.6   | 95   |
| 17.3 | 12   | 23.1  | DM+47 612         |        | m1v   | 9.5   | 96   |
| 17.6 | 13.6 | 10.2  | L1303 10          |        | m6v   | 15.1  | 102  |
| 19.2 | 15   | -23.6 | DM-44 775 A       |        | k6v   | 8.4   | 103  |

|      |      |       |                   |      |       |       |       |
|------|------|-------|-------------------|------|-------|-------|-------|
| 19.2 | 15   | -23.6 | DM-44 775 B       |      | m0v   | 13    | 103   |
| 18.2 | 14.4 | 2.7   | DM+6 398 A        |      | k3v   | 6.54  | 105   |
| 18.2 | 14.4 | 2.7   | DM+6 398 B        |      | m0v   | 13    | 105   |
| 18.2 | 14.4 | 2.7   | DM+6 398 C        |      | m4v   | 12.37 | 105   |
| 35.7 | 29.2 | -9.9  | Epsilon Ceti A    |      | f8v   | 4.77  | 105.4 |
| 35.7 | 29.2 | -9.9  | Epsilon Ceti B    |      | m0v   | 4.8   | 105.4 |
| 20.6 | 17.4 | 31.1  | Theta Persei A    |      | f7v   | 3.62  | 107   |
| 20.6 | 17.4 | 31.1  | Theta Persei B    |      | m2v   | 9.36  | 107   |
| 22.3 | 18.9 | -36.2 | Iota Horologii    |      | g3iv  | 4.63  | 108   |
| 17.5 | 14.8 | 10.8  | AC+25 7918        |      | m4v   | 11.12 | 109   |
| 33.9 | 29.1 | -15.3 | Tau1 Eridani      |      | f6v   | 3.7   | 111   |
| 30.2 | 27.4 | 27.7  | DM+33 529         |      | m0v   | 8.7   | 116   |
| 18.4 | 16.9 | -5.8  | DM-13 544         |      | k0v   | 6.57  | 117   |
| 12.8 | 11.8 | -35.7 | L127 97           |      | m0v   | 10.3  | 118   |
| 33.8 | 31.7 | 8.6   | AC+10 22-181      |      | m4v   | 11.4  | 120   |
| 17   | 17.8 | 28.7  | Iota Persei       |      | g4v   | 3.72  | 124   |
| 20.9 | 22   | 31    | AC+45 133-65      |      | m2v   | 9.5   | 125   |
| 19.8 | 21.7 | -31.3 | DM-46 943         |      | k4vii | 11.9  | 126   |
| 25.9 | 28.3 | -21.5 | Alpha Fornacis A  |      | f8iv  | 3.5   | 127   |
| 25.9 | 28.3 | -21.5 | Alpha Fornacis B  |      | m0v   | 6.5   | 127   |
| 22.6 | 24.8 | -26.6 | DM-38 1058        |      | m5vi  | 11.4  | 130   |
| 4.2  | 4.7  | 35.2  | AC+79 1584        |      | m2v   | 11.1  | 133   |
| 23.1 | 26.4 | 27.5  | DM+37 748         |      | m1v   | 9.6   | 134   |
| 10.9 | 12.6 | -32.6 | Zeta 1 Reticuli   |      | g2v   | 5.28  | 136   |
| 19.8 | 23   | 1.6   | Kappa Reticuli    |      | g5v   | 4.99  | 137   |
| 10.9 | 12.7 | -32.6 | Zeta 2 Reticuli   |      | g1v   | 4.98  | 138   |
| 9.5  | 11.2 | -13.9 | 82 Eridani        |      | g5v   | 5.29  | 139   |
| 28.1 | 34.3 | -4.4  | DM-5 642          |      | k5v   | 7.2   | 141   |
| 23   | 28.8 | -13.5 | DM-20 643         |      | k7v   | 8     | 142   |
| 30.6 | 38.5 | 3.1   | DM-63 110         |      | k5v   | 7.2   | 143   |
| 22.7 | 29.3 | 9.3   | G 5-43            |      | m3vi  | 11.9  | 143.3 |
| 6.4  | 8.4  | -1.9  | Epsilon Eridani A |      | k2v   | 6.13  | 144   |
| 6.4  | 8.4  | -1.9  | Epsilon Eridani B |      | m0v   | 13    | 144   |
| 16.6 | 21.9 | -27.4 | DM-45 1184        |      | m4vi  | 10.7  | 145   |
| 14.6 | 19.6 | -27.8 | DM-48 1011        |      | k7v   | 8.29  | 146   |
| 16.5 | 23.7 | -5.1  | Delta Eridani     | Rana | k0iv  | 3.77  | 150   |
| 24.3 | 35.3 | 14.2  | Wolf 219          |      | a0vii | 14.5  | 151   |
| 21.3 | 31.4 | 18.5  | DM+25 613         |      | k7vii | 9     | 154   |
| 22.5 | 36.1 | -5.3  | DM-7 699          |      | m0v   | 8.44  | 156   |
| 23.4 | 38.6 | -1.1  | DM-1 565 A        |      | k5v   | 7.6   | 157   |
| 23.4 | 38.6 | -1.1  | DM-1 565 B        |      | m3v   | 11    | 157   |
| 23.4 | 38.6 | -1.1  | DM-1 565 C        |      | m0v   | 13    | 157   |
| 22.2 | 38   | 14.8  | G 7-17            |      | m9v   | 14.7  | 157.2 |
| 21.5 | 38.1 | 17.6  | DM+21 587         |      | g1v   | 5.09  | 160   |
| 16.1 | 29.6 | -29.3 | DM-41 1288        |      | k0vii | 9.5   | 161.2 |
| 17.8 | 32.6 | 24.6  | AC+33 10883       |      | m1v   | 9.5   | 162   |
| 11.6 | 22.2 | 32.7  | Ross 28           |      | m5v   | 12.7  | 164   |
| 7    | 14   | -2.2  | Omicron2 Eridani  | Keid | k1v   | 5.99  | 166   |
| 7    | 14   | -2.2  | DM-7 781B         |      | a0vii | 11.09 | 166   |
| 7    | 14   | -2.2  | DM-7 781C         |      | m4v   | 12.73 | 166   |
| 10.9 | 22   | -33.2 | DM-53 889         |      | k5v   | 7.15  | 167   |
| 18.9 | 40.3 | 15.6  | Lowne 1           |      | m6v   | 15    | 168.1 |
| 12.8 | 29.5 | 12.8  | DM+21 652         |      | m1v   | 8.1   | 169   |



|      |      |       |                 |             |       |       |       |
|------|------|-------|-----------------|-------------|-------|-------|-------|
| 3.4  | 8    | 14.5  | AC+58 25001     |             | m4v   | 12.51 | 169.1 |
| 3.4  | 8    | 14.5  | AC+58 25002     |             | a0vii | 12.51 | 169.1 |
| 9.9  | 23.2 | 21    | Ross 594        |             | m7v   | 13.7  | 170   |
| 7.3  | 18.5 | 26.2  | DM+52 857       |             | k8v   | 8.6   | 172   |
| 15.3 | 41.3 | 16.7  | DM+20 802       |             | k3v   | 7.3   | 174   |
| 10.8 | 29.8 | 10.8  | DM+18 683       |             | m2v   | 9.87  | 176   |
| 12.9 | 38.3 | -12.4 | DM-17 954       |             | g1v   | 4.92  | 177   |
| 7.7  | 23.6 | 3     | Pi3 Orionis     |             | f6v   | 3.76  | 178   |
| 11.9 | 37.6 | 4.4   | Wolf 1539       |             | m4v   | 11.6  | 179   |
| 10.9 | 35.7 | -12.1 | L736 30         |             | m3v   | 12.1  | 180   |
| 7.7  | 26.5 | 32.7  | DM+49 1280      |             | m2v   | 9.2   | 181   |
| 13   | 46.1 | 1.4   | AC+1 1951-103   |             | m1v   | 8.8   | 182   |
| 7.9  | 28.6 | -3.1  | DM-5 1123 A     |             | k3v   | 6.4   | 183   |
| 7.9  | 28.6 | -3.1  | DM-5 1123 B     |             | m0v   | 13    | 183   |
| 7.6  | 28.2 | 38.8  | DM+52 911       |             | m0v   | 9.06  | 184   |
| 5.9  | 22.3 | -9.1  | DM-21 1051 A    |             | m1v   | 9.04  | 185   |
| 5.9  | 22.3 | -9.1  | DM-21 1051 B    |             | m0v   | 11.1  | 185   |
| 6.1  | 24.9 | -40.5 | Zeta Doradus    |             | f8v   | 4.1   | 189   |
| 7.8  | 33   | -11.2 | L737 9          |             | m5v   | 11.9  | 190   |
| 1.9  | 8.7  | -9.1  | Kapteyn's Star  |             | m0v   | 10.85 | 191   |
| 9.5  | 42.8 | 15.6  | AC+19 1165-38   |             | m5vi  | 10.5  | 192   |
| 6.1  | 29.5 | 31.2  | Alpha Aurigae A | Capella A   | g8iii | -0.6  | 194   |
| 6.1  | 29.5 | 31.2  | Alpha Aurigae B | Capella B   | f5iii | 0.34  | 194   |
| 6.1  | 30   | 31.5  | Alpha Aurigae   | Capella H A | m2v   | 9.55  | 195   |
| 6.1  | 30   | 31.5  | Alpha Aurigae   | Capella H B | m5v   | 13    | 195   |
| 7.1  | 36.5 | 31.3  | Lambda Aurigae  |             | g0v   | 3.84  | 197   |
| 8.2  | 43.2 | -2.4  | DM-3 1061A      |             | k3v   | 7.11  | 200   |
| 8.2  | 43.2 | -2.5  | DM-3 1061B      |             | m2v   | 12    | 200   |
| 4.2  | 27.6 | 4.7   | Ross 41         |             | m5v   | 12.78 | 203   |
| 6.6  | 44.6 | -2.8  | DM-3 1110       |             | k5v   | 6.9   | 204   |
| 2.5  | 18.9 | -1.3  | DM-3 1123       |             | m1v   | 9.12  | 205   |
| 6    | 45.4 | 7.9   | Ross 42 A       |             | m4v   | 10.73 | 206   |
| 6    | 45.4 | 7.9   | Ross 42 B       |             | m0v   | 13    | 206   |
| 6.1  | 48.9 | 1.6   | V 371 Orionis   |             | m3v   | 10.8  | 207.1 |
| 4.2  | 36.5 | 7.3   | DM+11 878       |             | m0v   | 8.5   | 208   |
| 2    | 20.7 | 28.1  | DM+53 934       |             | k1v   | 6.07  | 211   |
| 2    | 20.7 | 28.1  | DM+53 935       |             | m1v   | 9.62  | 212   |
| 1.7  | 18.8 | 4.1   | AC+12 1800-213  |             | m5v   | 12.73 | 213   |
| 2.4  | 19.5 | 37.4  | DM-62 780       |             | m0v   | 8.45  | 215   |
| 1.8  | 24.4 | -10.2 | DM-22 1210 A    |             | f6v   | 4.05  | 216   |
| 1.8  | 24.4 | -10.2 | DM-22 1210 B    |             | k2v   | 6.6   | 216   |
| 1.7  | 24.4 | -10.1 | VB 1            |             | m0v   | 13    | 216   |
| 1.7  | 27.8 | -20.6 | DM-36 2458      |             | m2v   | 11.5  | 218   |
| 1.1  | 30.2 | 11.1  | Chi Orionis     |             | g0v   | 4.43  | 222   |
| 0.6  | 19.5 | -1.5  | LP658 2         |             | k0vii | 15.62 | 223.2 |
| 0    | 4.3  | 31.3  | AC+82 1111      |             | m3v   | 10.56 | 226   |
| -1.1 | 30.8 | 5.6   | DM+10 1032 A    |             | m3v   | 10.65 | 228   |
| -1.1 | 30.8 | 5.6   | DM+10 1032 B    |             | m0v   | 12.7  | 228   |
| -0.7 | 17.3 | -7    | DM-21 1377      |             | m1v   | 9.33  | 229   |
| -0.4 | 7.4  | -27.4 | Alpha Mensae    |             | g5v   | 5.39  | 231   |
| -3.5 | 46.7 | -5.5  | Ross 417        |             | m5v   | 13.2  | 231.3 |
| -2.4 | 24.4 | 10.6  | Ross 64         |             | m6v   | 13.6  | 232   |
| -3.8 | 36.9 | 12.6  | DM+18 1214      |             | k3v   | 6.4   | 233   |

|       |      |       |                       |           |       |       |       |
|-------|------|-------|-----------------------|-----------|-------|-------|-------|
| -1.6  | 12.8 | -0.7  | Ross 614 A            |           | m7v   | 13.08 | 234   |
| -1.6  | 12.8 | -0.7  | Ross 614 B            |           | m0v   | 16.58 | 234   |
| -5.6  | 42.3 | -21.8 | L597 31               |           | m0v   | 11.9  | 236   |
| -3.5  | 23.4 | -38.6 | L182 44               |           | m0v   | 12.2  | 238   |
| -4.5  | 29.5 | 9.4   | DM+17 1320            |           | m1v   | 9.71  | 239   |
| -4.7  | 29.5 | -35.7 | DM-49 2340            |           | k0vii | 9.2   | 240   |
| -1.6  | 8.1  | -2.5  | Alpha Canis Majoris A | Sirius A  | a1v   | 1.42  | 244   |
| -1.6  | 8.1  | -2.5  | Alpha Canis Majoris B | Sirius B  | a0vii | 11.56 | 244   |
| -6.6  | 34.5 | 33.5  | Psi5 Aurigae          |           | g0v   | 4.37  | 245   |
| -4.8  | 23.5 | 42.2  | DM+60 1003            |           | m0v   | 7.7   | 247   |
| -6.8  | 30.4 | -2.8  | DM-5 1844 A           |           | k6v   | 6.68  | 250   |
| -6.8  | 30.4 | -2.9  | DM-5 1844 B           |           | m2v   | 10.2  | 250   |
| -3.7  | 15.7 | 10.6  | AC+33 25644           |           | m4v   | 11.03 | 251   |
| -9.3  | 37.3 | -27.4 | DM-35 3233 A          |           | f8v   | 4.8   | 255   |
| -9.3  | 37.3 | -27.4 | DM-35 3233 B          |           | m0v   | 5.1   | 255   |
| -5    | 19.6 | -19.8 | DM-44 3045 A          |           | m4v   | 11.8  | 257   |
| -5    | 19.6 | -19.8 | DM-44 3045 B          |           | m4v   | 12    | 257   |
| -10.3 | 38.8 | -19.5 | DM-25 3913            |           | k0v   | 6     | 259   |
| -11.9 | 44.7 | -5.2  | L886 6                |           | a0vii | 15.2  | 261   |
| -4.4  | 14.4 | 12    | AC+38 23616 A         |           | m5v   | 12.62 | 268   |
| -4.4  | 14.4 | 12    | AC+38 23616 B         |           | m0v   | 13    | 268   |
| -8.8  | 25.3 | -28.7 | DM-46 3046 A          |           | k2v   | 6.7   | 269   |
| -8.8  | 25.3 | -28.7 | DM-46 3046 B          |           | m0v   | 7.5   | 269   |
| -10.9 | 29.8 | 33.1  | AC+47 256-150         |           | m2v   | 10    | 272   |
| -4.5  | 11.4 | 1.1   | DM+5 1668 A           |           | m5v   | 11.98 | 273   |
| -4.5  | 11.5 | 1.1   | DM+5 1668 B           |           | m0v   | 13    | 273   |
| -10.8 | 26.8 | 32.4  | G 107-69 A            |           | m6vi  | 13.2  | 275.2 |
| -10.8 | 26.8 | 32.4  | G 107-69 B            |           | m5v   | 15.8  | 275.2 |
| -10.1 | 25.1 | 30.4  | G 107-70 C            |           | a0vii | 15.4  | 275.2 |
| -10.3 | 25.1 | 30.4  | G 107-70 D            |           | m5v   | 15.4  | 275.2 |
| -11.3 | 27.6 | 21.9  | DM+36 1638A           |           | m3v   | 10.32 | 277   |
| -11.3 | 27.6 | 21.9  | DM+36 1638B           |           | m0v   | 13    | 277   |
| -11.3 | 27.6 | 21.9  | Ross 989              |           | m4v   | 11.48 | 277   |
| -15.6 | 36.9 | 25    | Alpha Gemini A        | Castor A  | a1v   | 2.1   | 278   |
| -15.6 | 36.9 | 25    | Alpha Gemini B        | Castor B  | a1v   | 2.1   | 278   |
| -15.6 | 36.9 | 25    | Alpha Gemini C        | Castor C  | a5v   | 2.9   | 278   |
| -15.6 | 36.9 | 25    | Alpha Gemini D        | Castor D  | a5v   | 2.9   | 278   |
| -15.6 | 36.9 | 25    | YY Geminorum E        |           | k6v   | 8.26  | 278   |
| -15.6 | 36.9 | 25    | YY Geminorum F        |           | k6v   | 9.8   | 278   |
| -4.7  | 10.3 | 1     | Alpha Canis Minoris A | Procyon A | f5iv  | 2.64  | 280   |
| -4.7  | 10.3 | 1     | Alpha Canis Minoris B | Procyon B | f0vii | 13    | 280   |
| -18.4 | 40.5 | -2.8  | DM-3 2001             |           | k2v   | 6.5   | 282   |
| -18.5 | 40.5 | -2.8  | DM-3 2002             |           | k5v   | 8.3   | 282   |
| -13.8 | 30.1 | -10.4 | L745 46 A             |           | f0vii | 12.9  | 283   |
| -13.8 | 30.2 | -10.4 | L745 46 B             |           | m0v   | 18.4  | 283   |
| -8.5  | 17.7 | 1.2   | YZ Canis Minoris      |           | m4v   | 12.29 | 285   |
| -13.4 | 27.8 | 16.5  | Beta Gemini           | Pollux    | k0iii | 0.98  | 286   |
| -18.3 | 36.9 | 15.4  | Wolf 1421             |           | m2v   | 10.7  | 289   |
| -3.6  | 6.9  | 45.9  | DM+80 238             |           | g8v   | 5.78  | 290   |

|       |      |       |                      |         |       |       |       |
|-------|------|-------|----------------------|---------|-------|-------|-------|
| -21.1 | 40.7 | -11.3 | DM-13 2267 A         |         | g1v   | 4.91  | 291   |
| -21.1 | 40.7 | -11.3 | DM-13 2267 B         |         | m0v   | 5.36  | 291   |
| -17.9 | 34   | -22.8 | DM-34 4036 A         |         | f5v   | 4.4   | 292   |
| -17.9 | 34   | -22.8 | DM-34 4036 B         |         | k3vi  | 7     | 292   |
| -3.4  | 6.3  | -17.5 | L97 12               |         | m5v   | 15.5  | 293   |
| -17.7 | 28.9 | -2.6  | DM-4 2226            |         | m3vi  | 9.9   | 297   |
| -11.4 | 18   | 3.3   | Ross 619             |         | m5v   | 13.66 | 299   |
| -9.6  | 14.9 | -7    | L674 15              |         | m0v   | 15    | 300   |
| -22.6 | 33.3 | -9    | DM-12 2449           |         | g8v   | 5.49  | 302   |
| -21.1 | 27.1 | -21   | DM-31 6229           |         | k0v   | 5.9   | 309   |
| -9.9  | 12.6 | 38.5  | DM+67 552 A          |         | m1v   | 8.76  | 310   |
| -9.9  | 12.6 | 38.5  | DM+67 552 B          |         | m0v   | 11.7  | 310   |
| -27.7 | 33.8 | -18.1 | DM-22 2345           |         | f6v   | 5.8   | 314   |
| -14.1 | 17.2 | 7.4   | LP425-140            |         | m6v   | 19.9  | 316.1 |
| -16.5 | 19.8 | -11.2 | L675 81              |         | m0v   | 13.5  | 317   |
| -15.6 | 18.6 | -15.7 | DM-32 5613           |         | a0vii | 12.3  | 318   |
| -17.2 | 20.1 | -21.3 | DM-38 4789           |         | k1v   | 6.46  | 320   |
| -26.1 | 28.5 | 21    | DM+28 1660           |         | g8v   | 5.3   | 324   |
| -26.2 | 28.5 | 21    | G 47-9               |         | m5v   | 12.5  | 324   |
| -8    | 8.5  | 33.8  | DM+71 482 A          |         | k5v   | 8.48  | 325   |
| -8    | 8.5  | 33.8  | DM+71 482 B          |         | m0v   | 8.7   | 325   |
| -26.4 | 28.3 | -8.9  | L820 19 A            |         | m6v   | 12    | 326   |
| -26.4 | 28.3 | -8.9  | L820 19 B            |         | m0v   | 12.3  | 326   |
| -26.1 | 27.9 | -3.6  | DM-4 2490            |         | g3v   | 5.65  | 327   |
| -32.4 | 33.9 | 9.8   | DM+12 1944           |         | m5v   | 9.8   | 330   |
| -22.9 | 23.6 | 36.8  | Iota Ursae Majoris A | Talitha | a7v   | 2.24  | 331   |
| -22.9 | 23.6 | 36.8  | Iota Ursae Majoris B |         | m1v   | 9.9   | 331   |
| -22.9 | 23.6 | 36.8  | Iota Ursae Majoris C |         | m0v   | 13    | 331   |
| -22.9 | 23.6 | 36.8  | Iota Ursae Majoris D |         | m0v   | 10.2  | 331   |
| -22.9 | 23.4 | 29.4  | DM+42 1956 A         |         | f5v   | 3.5   | 332   |
| -22.9 | 23.4 | 29.4  | DM+42 1956 B         |         | m0v   | 5.33  | 332   |
| -21   | 21.3 | -32.4 | L316 62              |         | m2v   | 13.7  | 333   |
| -33.2 | 31.9 | -7    | DM-8 2582 A          |         | m0v   | 8.7   | 334   |
| -33.2 | 31.9 | -7    | DM-8 2582 B          |         | m0v   | 13    | 334   |
| -8.8  | 7.9  | 15.6  | DM+53 1320           |         | m0v   | 8.72  | 338   |
| -8.8  | 7.9  | 15.6  | DM+53 1321           |         | m0v   | 8.82  | 338   |
| -20.6 | 18.4 | 37.5  | G 195-19             |         | a0vii | 13    | 339.1 |
| -12   | 10   | -27.2 | DM-59 2351           |         | m1v   | 11    | 341   |
| -36   | 28.4 | -2.1  | DM-2 2901            |         | f6v   | 3.9   | 348   |
| -36   | 28.4 | -2.1  | DM-2 2902            |         | k0vi  | 6.4   | 348   |
| -29   | 22.7 | 3.7   | DM+6 2182            |         | k3v   | 6.93  | 349   |
| -22.8 | 17.6 | -6.9  | DM-12 2918 A         |         | m4v   | 11.02 | 352   |
| -22.8 | 17.6 | -6.9  | DM-12 2918 B         |         | m4v   | 11    | 352   |
| -30.5 | 23.5 | 28.5  | DM+36 1970           |         | m2v   | 9.4   | 353   |
| -19.4 | 14.4 | 17.5  | DM+36 1979           |         | g8iv  | 5.6   | 356   |
| -19.4 | 14.4 | 17.5  | DM+36 1979           |         | m0v   | 13.2  | 356   |
| -20   | 14.8 | -9.8  | L678 39              |         | k0vii | 13.1  | 357   |
| -20.9 | 14.9 | -22.3 | DM-40 5404           |         | m0v   | 12.3  | 358   |
| -26.8 | 19   | 13.4  | Ross 92              |         | m6v   | 15.5  | 359   |

|       |      |       |                    |                 |      |       |       |
|-------|------|-------|--------------------|-----------------|------|-------|-------|
| -10.6 | 7.5  | 36    | AC+70 4336         |                 | m3v  | 10.25 | 360   |
| -34.5 | 24.4 | 10.1  | AC+13 1301-119     |                 | m2v  | 9.8   | 361   |
| -10.6 | 7.4  | 36    | AC+70 4337         |                 | m4v  | 10.9  | 362   |
| -34   | 23.7 | -18.2 | DM-23 8646         |                 | g0v  | 4.2   | 364   |
| -28.4 | 19.8 | 32.1  | DM+43 1953         |                 | k5v  | 7.31  | 365   |
| -17.3 | 11.8 | -21.4 | DM-45 5378         |                 | m4vi | 10.8  | 367   |
| -28.5 | 18.9 | 35.6  | DM+46 1551         |                 | g1v  | 4.2   | 368   |
| -33.1 | 21.3 | -8.5  | DM-11 2741         |                 | m2v  | 9.54  | 369   |
| -20.2 | 12.9 | -22.6 | DM-42 5678         |                 | k5v  | 7.62  | 370   |
| -36.2 | 22.8 | -2.6  | DM-2 3000          |                 | m0v  | 9.8   | 372   |
| -15.2 | 9.4  | 35    | DM+63 869          |                 | m1v  | 8.6   | 373   |
| -25.9 | 15.4 | -31.4 | DM-45 5627         |                 | m5vi | 11    | 375   |
| -33   | 19.1 | -22.2 | DM-29 8019         |                 | m4vi | 10    | 377   |
| -27.6 | 16   | 35.8  | DM+48 1829         |                 | m2v  | 9.2   | 378   |
| -8.4  | 4.4  | 11.1  | DM+50 1725         |                 | k7v  | 8.32  | 380   |
| -24.9 | 13   | -1.2  | L968 22            |                 | m0v  | 11.12 | 381   |
| -25.8 | 13.4 | -1.8  | DM-3 2870 A        |                 | m2v  | 9.6   | 382   |
| -25.8 | 13.4 | -1.8  | DM-3 2870 B        |                 | m0v  | 13    | 382   |
| -33.7 | 16.7 | -7.8  | L824 28            |                 | m0v  | 10.8  | 386   |
| -23.1 | 9.9  | 0.4   | DM+1 2447          |                 | m2v  | 10.2  | 393   |
| -20.1 | 8.5  | 32.6  | DM+56 1458         |                 | k7v  | 8.29  | 394   |
| -20.1 | 8.5  | 32.6  | DM+56 1459         |                 | f8v  | 4.44  | 395   |
| -29.5 | 12.4 | 32.9  | DM+46 1635         |                 | k7v  | 8.1   | 397   |
| -29.5 | 11.1 | -3.7  | L897 16            |                 | m0v  | 12.8  | 399   |
| -28.3 | 9.9  | 24    | DM+39 2376A        |                 | m2v  | 8.95  | 400   |
| -28.3 | 9.9  | 24    | DM+39 2376B        |                 | m0v  | 11.8  | 400   |
| -31.1 | 10.7 | -11.3 | DM-18 3019         |                 | m0v  | 12.3  | 401   |
| -21.7 | 7    | 2.8   | Wolf 358           |                 | m5v  | 12.42 | 402   |
| -35.5 | 11.2 | 9.4   | G 44-42            |                 | m4v  | 13.5  | 403   |
| -7.3  | 2.1  | 0.9   | Wolf 359           |                 | m8v  | 16.68 | 406   |
| -32.2 | 9.1  | 28.7  | DM+41 2147         |                 | g0v  | 4.4   | 407   |
| -19.2 | 5.3  | 8.4   | AC+23 468-46       |                 | m2vi | 10.93 | 408   |
| -34.3 | 9.1  | 14.5  | DM+22 2302         |                 | m2v  | 9.2   | 410   |
| -6.5  | 1.7  | 4.8   | DM+36 2147 A       | Lalande 21185   | m2v  | 10.49 | 411   |
| -6.5  | 1.7  | 4.8   | DM+36 2147 B       | Lalande 21185   | m0v  | 13    | 411   |
| -12.3 | 3.1  | 12.1  | AC+19 1165-3       |                 | m2v  | 10.12 | 412   |
| -12.3 | 3.1  | 12.1  | WX Ursae Majoris   |                 | m8v  | 15.88 | 412   |
| -28.7 | 6.7  | -13.3 | DM-23 9765         |                 | m0v  | 12.1  | 413.1 |
| -33.8 | 7.7  | 20.5  | DM+31 2240 A       |                 | k9v  | 7.9   | 414   |
| -33.8 | 7.7  | 20.5  | DM+31 2240 B       |                 | m2v  | 9.5   | 414   |
| -12.1 | 2.5  | 42.2  | DM+74 456A         |                 | k5v  | 7.05  | 420   |
| -12.1 | 2.5  | 42.2  | DM+74 456B         |                 | m2v  | 10.7  | 420   |
| -22.5 | 4.5  | -35.7 | L192 72            |                 | m0v  | 12.2  | 422   |
| -25   | 4.9  | 15.7  | Xi Ursae Majoris A | Alula Australis | g0v  | 4.9   | 423   |
| -25   | 4.9  | 15.7  | Xi Ursae Majoris B |                 | m0v  | 13    | 423   |
| -25   | 4.9  | 15.7  | Xi Ursae Majoris C |                 | g0v  | 5.38  | 423   |
| -25   | 4.9  | 15.7  | Xi Ursae Majoris D |                 | m0v  | 13    | 423   |
| -10.9 | 2    | 25    | DM+66 717          |                 | m1v  | 9.7   | 424   |

|       |      |       |                           |          |       |       |       |
|-------|------|-------|---------------------------|----------|-------|-------|-------|
| -30.2 | 5.4  | -11.3 | DM-19 3242 A              |          | m0v   | 8.7   | 425   |
| -30.2 | 5.4  | -11.3 | DM-19 3242 B              |          | m0v   | 11    | 425   |
| -35.6 | 6    | 14.3  | Ross 627                  |          | f0vii | 13.9  | 427   |
| -17.2 | 2.8  | -31.8 | DM-60 3532 A              |          | k7v   | 7.34  | 428   |
| -17.2 | 2.8  | -31.8 | DM-60 3532 B              |          | m0v   | 8.36  | 428   |
| -28.8 | 3.8  | -25.1 | L396 7                    |          | m0v   | 12.5  | 431   |
| -24   | 3.1  | 28.6  | DM+50 1832                |          | k3v   | 8     | 431.2 |
| -26   | 3.1  | -16.8 | DM-32 8179                |          | k0v   | 6.09  | 432   |
| -26   | 3.1  | -16.8 | VB 4                      |          | m0v   | 15    | 432   |
| -30.1 | 3.5  | -19.2 | DM-31 9113                |          | m2vi  | 9.6   | 433   |
| -24.4 | 2.2  | 16.7  | 61 Ursae Majoris          |          | g8v   | 5.55  | 434   |
| -28.8 | 2.6  | -28.1 | DM-43 7228                |          | k5v   | 7.3   | 435   |
| -29   | 2.5  | 14.7  | DM+27 28217               |          | m3v   | 10.7  | 436   |
| -16.9 | 1.4  | -21.3 | DM-51 5974                |          | v0vii | 11.7  | 438   |
| -21.5 | 1.7  | 24.5  | DM+49 2079                |          | k2v   | 7.8   | 438.1 |
| -6.8  | 0.5  | -14.3 | L145 141                  |          | a0vii | 13.01 | 440   |
| -25.4 | 1.7  | -21.5 | DM-39 7301                |          | g5v   | 4.85  | 442   |
| -25.4 | 1.7  | -21.5 | VB 5                      |          | m0v   | 15    | 442   |
| -38.4 | 2.5  | -7.9  | L829 26                   |          | m0v   | 13    | 443   |
| -40.2 | 2.7  | 20.7  | DM+27 2055                |          | k3v   | 8     | 443.1 |
| -3.2  | 0.2  | 16.3  | AC+79 3888                |          | m4vi  | 12.38 | 445   |
| -10.9 | 0.7  | 0.2   | Ross 128                  |          | m5v   | 13.5  | 447   |
| -41.4 | 2.4  | 10.9  | Beta Leonis               | Denebola | a3v   | 1.54  | 448   |
| -32.6 | 1.6  | 1.1   | Beta Virginis             | Zavijah  | f8v   | 3.6   | 449   |
| -27.9 | 1.2  | 19.9  | DM+36 2219                |          | m1v   | 9.7   | 450   |
| -22.7 | 0.9  | 17.7  | DM+38 2285                |          | g8vi  | 6.71  | 451   |
| -22.7 | 0.9  | 17.7  | DM+38 2285                |          | m0v   | 12    | 451   |
| -39   | 1.5  | -4.9  | L901 10                   |          | m4v   | 11.6  | 452   |
| -33.8 | 1.2  | 6     | Ross 119                  |          | m0v   | 14.1  | 452.1 |
| -28.4 | 0.5  | -14.8 | DM-26 8883                |          | k5v   | 7     | 453   |
| -40.1 | 0.3  | -7.2  | DM-9 3413                 |          | k0iv  | 5.06  | 454   |
| -45   | -1.2 | -20.5 | Alpha Crucis A            |          | f2v   | 3.1   | 455.3 |
| -24.5 | -1.1 | 34.5  | DM+55 1519                |          | m2v   | 9.3   | 458   |
| -24.4 | -1.1 | 34.5  | G 197-50                  |          | m3v   | 14.7  | 458   |
| -16.4 | -1   | 21.6  | C1                        |          | a0vii | 13.7  | 459.1 |
| -27.9 | -1.8 | 27.6  | DM+45 2014                |          | k4v   | 8.2   | 459.2 |
| 20.5  | 5    | -40.8 | DM-28 302                 |          | m0v   | 11.8  | 46    |
| -33.4 | -2.9 | 30.5  | DM+42 2296                |          | m0v   | 8.5   | 462   |
| -18.8 | -1.8 | 39.1  | AC+13 14332               |          | m4v   | 11    | 463   |
| -28.1 | -2.8 | -9.2  | Ross 695                  |          | m4v   | 11.9  | 465   |
| -6.9  | -0.8 | -20.3 | L68 28 A                  |          | k0vii | 12.5  | 467   |
| -6.9  | -0.8 | -20.3 | L68 27 B                  |          | m0v   | 14.4  | 467   |
| -41.1 | -4.8 | 6.3   | Wolf 414                  |          | m5vi  | 11.5  | 469   |
| -44.4 | -5.6 | 7.1   | DM+9 2636                 |          | m1v   | 9.1   | 471   |
| -35   | -4.5 | 23.5  | DM+34 2323                |          | k4v   | 8.2   | 471.1 |
| -17.5 | -2.4 | -44.6 | DM-68 1095                |          | k0v   | 6.3   | 472   |
| -13.8 | -1.9 | 2.2   | Wolf 424 A                |          | m5v   | 14.98 | 473   |
| -13.8 | -1.9 | 2.2   | Wolf 424 B                |          | m0v   | 15.2  | 473   |
| -22.2 | -3.1 | 19.8  | Beta Canum<br>Venaticorum |          | g0v   | 4.46  | 475   |
| -45.5 | -6.5 | 8.1   | AC+10 95-26               |          | m4vi  | 10.6  | 476   |
| -29.7 | -4.4 | -30.7 | DM-45 7872                |          | m1v   | 10.9  | 477   |
| -13.7 | -2.1 | 14.3  | DM +46 1797               |          | k4v   | 8.2   | 477.1 |

|       |       |       |                         |               |       |       |       |
|-------|-------|-------|-------------------------|---------------|-------|-------|-------|
| -16.5 | -2.6  | -21.2 | DM-51 6859              |               | m3v   | 11.06 | 479   |
| -38.4 | -6.2  | 8.2   | Wolf 433                |               | m4v   | 10.9  | 480   |
| -20.8 | -3.6  | 14.3  | DM +34 2342             |               | k4v   | 8.2   | 480.2 |
| -45.6 | -7.8  | 12.9  | DM+16 2404              |               | k8v   | 7.3   | 481   |
| -32.5 | -5.6  | -0.7  | Gamma Virginis A        | Arich Porrima | f0v   | 3.46  | 482   |
| -32.5 | -5.6  | -0.7  | Gamma Virginis B        |               | f0v   | 3.48  | 482   |
| -29.6 | -5.9  | 19.4  | DM+33 2269              |               | k3v   | 8     | 484.1 |
| -27.7 | -5.6  | 4.9   | Wolf 437                |               | m4v   | 11.68 | 486   |
| -11.1 | -2.3  | 25.7  | AC+66 3955              |               | m4v   | 11.2  | 487   |
| -35.1 | -7.5  | 0.3   | DM+0 2989               |               | m0v   | 8.31  | 488   |
| -38.5 | -9.9  | 2.6   | Wolf 457                |               | g2vii | 15.5  | 492   |
| -34.9 | -9.1  | 3.7   | Wolf 461 A              |               | m5v   | 13    | 493.1 |
| -34.9 | -9.1  | 3.7   | Wolf 461 B              |               | m0v   | 13    | 493.1 |
| -37.6 | -9.8  | 8.7   | DM+13 2618              |               | m2v   | 9.4   | 494   |
| -39.9 | -10.6 | -1.4  | Ross 974                |               | k0vi  | 12.3  | 495   |
| -33.9 | -10.6 | -27.3 | DM-37 8437              |               | g3v   | 4.6   | 501.2 |
| -22.9 | -7.2  | 12.8  | Beta Comae<br>Berenices |               | g0v   | 4.66  | 502   |
| -39.6 | -13.3 | 7.1   | DM+10 2531              |               | g0v   | 4.65  | 504   |
| -34   | -11.5 | 11.1  | DM+17 2611 A            |               | k2v   | 6.28  | 505   |
| -34   | -11.5 | 11.1  | DM+17 2611 B            |               | m2v   | 9.3   | 505   |
| -24.7 | -8.5  | -8.5  | DM-17 3813              |               | g6v   | 5.12  | 506   |
| -25.4 | -8.9  | 19    | DM+35 2436A             |               | m0v   | 9.5   | 507   |
| -25.4 | -8.9  | 19    | DM+35 2436B             |               | m3v   | 12.1  | 507   |
| -17.6 | -6.2  | 20.7  | DM+48 2108A             |               | m2v   | 9.3   | 508   |
| -17.6 | -6.2  | 20.7  | DM+48 2108B             |               | m0v   | 10.1  | 508   |
| -36.2 | -14.2 | -1.3  | Ross 486 A              |               | m4v   | 10.9  | 512   |
| -36.2 | -14.2 | -1.3  | Ross 486 B              |               | m6v   | 13.8  | 512   |
| -22.7 | -9.2  | 4.5   | DM+11 2576 A            |               | m1v   | 9.65  | 514   |
| -22.7 | -9.2  | 4.5   | DM+11 2576 B            |               | m0v   | 13    | 514   |
| -22.6 | -9.9  | 1.7   | Wolf 489                |               | k0vii | 15.36 | 518   |
| -23.5 | -10.4 | 18.5  | DM+36 2393              |               | m2v   | 9.1   | 519   |
| -19.4 | -8.8  | 22.2  | DM+46 1889              |               | m2v   | 10.1  | 521   |
| -43   | -19.5 | -3.3  | DM-3 3508 A             |               | k6v   | 8.8   | 521.1 |
| -43   | -19.5 | -3.3  | DM-3 3508 B             |               | m0v   | 13    | 521.1 |
| -20.3 | -9.6  | -30.7 | L258 146                |               | k0vii | 14    | 524   |
| -28.8 | -13.9 | 10.4  | DM+18 2776              |               | m1v   | 9.76  | 525   |
| -14.1 | -6.9  | 4.2   | DM+15 2620              |               | m4v   | 10.02 | 526   |
| -24.9 | -12.6 | 14.3  | DM+27 2296              |               | k6v   | 7.26  | 528   |
| -24.9 | -12.6 | 14.3  | DM+27 2296              |               | k6v   | 7.7   | 528   |
| -33.8 | -17.1 | -15.2 | DM-21 3781              |               | k6v   | 7.67  | 529   |
| -25.4 | -13.2 | 34.3  | DM+50 2030              |               | m0v   | 8.3   | 532   |
| -26.8 | -14.3 | 10.2  | Eta Bootis A            | Mufrid        | g0iv  | 2.72  | 534   |
| -26.8 | -14.3 | 10.2  | Eta Bootis B            |               | m0v   | 13    | 534   |
| -30.8 | -17.6 | -1.5  | DM-1 2892               |               | m0v   | 9.6   | 536   |
| -24.3 | -14.1 | 29.5  | DM+47 2112 A            |               | m3v   | 9.5   | 537   |
| -24.3 | -14.1 | 29.5  | DM+47 2112 B            |               | m3v   | 9.6   | 537   |
| -33.3 | -20   | -28.3 | Theta Centauri          | Menkent       | k0iii | 0.9   | 539   |
| -37.4 | -23.9 | -9.3  | Ross 845                |               | m5v   | 12.8  | 540.2 |
| -28   | -18.4 | 11.7  | Alpha Bootis            | Arcturus      | k2iii | -0.24 | 541   |
| -13.4 | -9    | -27   | DM-58 5564              |               | k3v   | 6.74  | 542   |
| -35.7 | -24.3 | -5.4  | Wolf 534                |               | m4v   | 13.9  | 543   |

|       |       |       |                             |                 |       |       |       |
|-------|-------|-------|-----------------------------|-----------------|-------|-------|-------|
| -28.9 | -19.8 | -5.8  | Ross 848                    |                 | m5v   | 12.8  | 545   |
| -29.8 | -20.8 | 20.8  | DM+30 2512                  |                 | k8v   | 8     | 546   |
| -34.9 | -27.7 | 19.6  | DM+24 2733A                 |                 | m1v   | 8.84  | 548   |
| -36.1 | -26.1 | 19.6  | DM+24 2733B                 |                 | m2v   | 9.1   | 548   |
| -23.9 | -17.3 | 37.8  | Theta Bootis A              | Asellus Primus  | f7v   | 3.22  | 549   |
| -23.9 | -17.3 | 37    | Theta Bootis B              |                 | m3vi  | 10.3  | 549   |
| -23.1 | -16.8 | 38.5  | G 200-38                    |                 | k1vii | 12.7  | 549   |
| -1.6  | -1.2  | -3.8  | Proxima Centauri            |                 | m5v   | 15.45 | 551   |
| -34.5 | -25.8 | 12.1  | DM+16 2658                  |                 | m3v   | 10    | 552   |
| -30.7 | -23.2 | -8.3  | AC-12 2306                  |                 | m4v   | 13    | 553.1 |
| -15.8 | -12.3 | -4.4  | DM-11 3759                  |                 | m4v   | 12.38 | 555   |
| -1.7  | -1.4  | -3.9  | Alpha Centauri A            | Rigel Kentaurus | g2v   | 4.35  | 559   |
| -1.7  | -1.4  | -3.9  | Alpha Centauri B            |                 | k0v   | 5.69  | 559   |
| -31.6 | -28.5 | 19    | DM+24 2786B                 |                 | g2v   | 5.15  | 564   |
| -31.6 | -28.5 | 19    | DM+24 2786A                 |                 | m0v   | 13    | 564   |
| -32.9 | -29.9 | -19.9 | DM-23 11940                 |                 | k5v   | 7     | 565   |
| -15.4 | -14   | 7.2   | Xi Bootis A                 |                 | g8v   | 5.53  | 566   |
| -15.4 | -14   | 7.2   | Xi Bootis B                 |                 | m0v   | 15    | 566   |
| -15.4 | -14   | 7.2   | Xi Bootis C                 |                 | k4v   | 7.69  | 566   |
| -26.9 | -24.9 | 12.8  | DM+19 2881 A                |                 | k1v   | 5.66  | 567   |
| -26.9 | -24.9 | 12.8  | DM+19 2881 B                |                 | m0v   | 13    | 567   |
| -22.8 | -21.2 | 13.6  | Ross 52 A                   |                 | m5vi  | 11.5  | 568   |
| -22.8 | -21.2 | 13.6  | Ross 52 B                   |                 | m5v   | 12.1  | 568   |
| -23.9 | -22.3 | 9.5   | DM+16 2708                  |                 | m0v   | 10.1  | 569   |
| -12.3 | -11.7 | -6.6  | DM-20 2125                  |                 | k5v   | 7.06  | 570   |
| -12.3 | -11.7 | -6.6  | DM-20 4123                  |                 | m2v   | 9.21  | 570   |
| -20.3 | -20.1 | 29.1  | DM+45 2247                  |                 | m0v   | 8.6   | 572   |
| -18.3 | -18.6 | 28.7  | 44 I Bootis A               |                 | g1v   | 4.87  | 575   |
| -18.3 | -18.6 | 28.7  | 44 I Bootis B               |                 | g2v   | 5.47  | 575   |
| -18.3 | -18.6 | 28.7  | 44 I Bootis C               |                 | g2v   | 6     | 575   |
| -27.2 | -28.5 | 18.4  | DM+25 2874                  |                 | k7v   | 9.32  | 579   |
| -30.7 | -32.5 | 10.6  | DM+13 2901                  |                 | g6v   | 4.6   | 579.1 |
| -13.8 | -16   | -2.8  | DM-7 4003                   |                 | m5v   | 11.5  | 581   |
| -21.8 | -26.3 | 10.8  | Ross 508                    |                 | m6v   | 14.8  | 585   |
| -8.9  | -11.5 | -12.7 | DM-40 9712                  |                 | m4vi  | 11.2  | 588   |
| -20   | -26.8 | 10.7  | AC+18 1890-112              |                 | m4v   | 11.8  | 589   |
| -20   | -26.8 | 10.7  | L1272 21                    |                 | m6v   | 15    | 589   |
| -18.9 | -25.3 | -24.4 | L480 69                     |                 | k0vii | 13.4  | 590   |
| -20.9 | -28.3 | -8.8  | Ross 802                    |                 | m5v   | 13.6  | 592   |
| -16   | -22.7 | -9.8  | L768 119                    |                 | m5v   | 11.9  | 595   |
| -19.3 | -28.6 | 4.5   | Lambda Serpenti             |                 | g0v   | 4.3   | 598   |
| -19.8 | -29.3 | -27.4 | DM-37 10500 A               |                 | g6v   | 5.34  | 599   |
| -19.8 | -29.3 | -27.4 | DM-37 10500 B               |                 | a0vii | 12.1  | 599   |
| -10.1 | -15.9 | -37.4 | Beta Trianguli<br>Australis |                 | f2iv  | 2.4   | 601   |
| -20.3 | -33.1 | 10.9  | Gamma Serpenti              |                 | f6v   | 3.4   | 603   |
| -15.4 | -26.8 | 11.6  | L1346 53                    |                 | m4v   | 14.2  | 609   |
| -15.4 | -27.6 | 25.7  | DM+39 2947                  |                 | g8v   | 6.18  | 611   |
| -12.4 | -23.6 | -41.7 | DM-57 6303                  |                 | k0v   | 6.64  | 615   |
| -6.2  | -12.7 | 33.7  | DM+67 935A                  |                 | m0v   | 8.37  | 617   |
| -6.2  | -12.7 | 33.8  | DM+67 925B                  |                 | m3v   | 10.47 | 617   |
| -8.7  | -17.8 | -15.2 | DM-37 10765 A               |                 | m4vi  | 11.2  | 618   |
| -8.7  | -17.8 | -15.2 | DM-37 10765 B               |                 | m7v   | 16.6  | 618   |

|       |       |       |                 |       |       |       |
|-------|-------|-------|-----------------|-------|-------|-------|
| -15.9 | -33.7 | 32.4  | DM+41 2695      | m0v   | 8.1   | 619   |
| -17.9 | -38.4 | -19.4 | DM-24 12677     | m2v   | 9.6   | 620   |
| -18.5 | -40.6 | -17.9 | DM-21 4352      | k5vii | 9.5   | 622   |
| -6.5  | -14.3 | 17.6  | AC-48 1595 89   | m3vi  | 10.97 | 623   |
| -5    | -11   | -33   | Zeta Draconis A | g0v   | 4.7   | 624   |
| -5    | -11   | -33   | Zeta Draconis B | m0v   | 13    | 624   |
| -11.2 | -25.2 | 38.4  | AC+54 1646-56   | m2v   | 9.6   | 625   |
| -5.1  | -11.8 | -2.9  | DM-12 4523 A    | m5v   | 12.1  | 628   |
| -5.1  | -11.8 | -2.9  | DM-12 4523 B    | m0v   | 13    | 628   |
| -9.9  | -24.9 | 41.5  | LP101-15 A      | m4v   | 12    | 630.1 |
| -9.9  | -24.9 | 41.5  | LP101-15 B      | m0v   | 13    | 630.1 |
| -9.9  | -24.9 | 41.5  | LP101-16 C      | m0v   | 14.1  | 630.1 |
| -13.2 | -33.3 | -1.4  | DM-1 3220       | k0v   | 5.56  | 631   |
| -7.7  | -20.3 | -22.3 | L339 19         | c0vii | 14.5  | 633   |
| -9.2  | -25.1 | 16.4  | Zeta Herculis A | g0iv  | 2.97  | 635   |
| -9.2  | -25.1 | 16.4  | Zeta Herculis B | k0v   | 5.57  | 635   |
| -4.7  | -13.4 | -45.9 | L74 113         | m0v   | 12.2  | 637   |
| -8.6  | -24.7 | 17.3  | DM +33 2777     | k7v   | 8.19  | 638   |
| -5.8  | -19.2 | -2.9  | Wolf 629 A      | m4vi  | 12.73 | 643   |
| -5.8  | -19.2 | -2.9  | Wolf 629 B      | m0v   | 13    | 643   |
| -5.8  | -19.2 | -3    | DM-8 4352       | m4v   | 10.8  | 644   |
| -5.8  | -19.2 | -3    | VB 8            | m0v   | 17.69 | 644   |
| -10.6 | -36.7 | -31.5 | DM-39 10940 A   | k5v   | 7.6   | 646   |
| -10.6 | -36.7 | -31.5 | DM-39 10940 B   | m0vi  | 9.5   | 646   |
| -8.5  | -29.7 | 14.9  | DM+25 3173      | m2v   | 9.6   | 649   |
| -8.9  | -34.6 | -3.2  | DM-4 4225       | k5v   | 7.53  | 653   |
| -8.9  | -34.6 | -3.2  | DM-4 4226       | m3v   | 9.87  | 654   |
| -7.1  | -28.9 | 11.7  | Ross 863        | m3v   | 11.6  | 655   |
| -8.9  | -39.3 | -1.3  | L989 20 A       | g0vii | 11.5  | 660   |
| -8.9  | -39.3 | -1.3  | L989 20 B       | m0v   | 11.7  | 660   |
| -3.2  | -16.4 | 15    | DM+45 2505      | m3v   | 10.91 | 661   |
| -3.2  | -16.4 | 15    | DM+45 2505      | m3v   | 11.28 | 661   |
| -3.3  | -15.6 | -8    | DM-26 12026 A   | k1v   | 6.38  | 663   |
| -3.3  | -15.6 | -8    | DM-26 12026 B   | k1v   | 6.41  | 663   |
| -3.3  | -15.6 | -7.9  | DM-26 12036 C   | k5v   | 7.66  | 664   |
| -3.4  | -16.8 | -18.1 | DM-46 11370 A   | g8v   | 6.12  | 666   |
| -3.4  | -16.8 | -18.1 | DM-46 11370 B   | m0v   | 9.28  | 666   |
| -3.7  | -18.8 | -13.4 | DM-34 11626 A   | k3v   | 7.03  | 667   |
| -3.7  | -18.8 | -13.4 | DM-34 11626 B   | k5v   | 7.9   | 667   |
| -3.7  | -18.8 | -13.4 | DM-34 11626 C   | m2v   | 10.89 | 667   |
| -5.7  | -30.6 | 15.4  | Ross 868        | m4v   | 11.2  | 669   |
| -6.2  | -33   | 16.7  | Ross 867        | m5v   | 12.6  | 669   |
| -5.4  | -29.2 | 26.4  | AC+41 726-154   | m4vi  | 11    | 671   |
| -6.8  | -37.1 | 24    | DM+32 2896      | g2v   | 4.71  | 672   |
| -4    | -24.2 | 0.9   | DM +2 3312      | k7v   | 8.15  | 673   |
| -1.6  | -10.3 | -11.1 | DM-46 11540     | m4vi  | 11.03 | 674   |
| -2.6  | -16.6 | 40.1  | DM+67 1014 A    | k0v   | 5.81  | 675   |
| -2.6  | -16.6 | 40.1  | DM+67 1014 B    | m0v   | 13    | 675   |
| -3.5  | -23.6 | -30.1 | DM-51 10924 A   | m0v   | 10.1  | 676   |
| -3.5  | -23.6 | -30.1 | DM-51 10924 B   | m0v   | 14.4  | 676   |
| -4.5  | -31.5 | 3.1   | DM+5 3409 A     | m1v   | 9.36  | 678.1 |
| -4.5  | -31.5 | 3.1   | DM+5 3409 B     | m0v   | 14    | 678.1 |
| -3.3  | -25.8 | -29.5 | DM-48 11837     | m0v   | 10.1  | 680   |



|      |       |       |                |      |       |       |       |
|------|-------|-------|----------------|------|-------|-------|-------|
| -1.3 | -10.9 | -10.7 | DM-44 11909    |      | m5v   | 12.8  | 682   |
| -2.6 | -22.8 | 42.9  | 26 Draconis A  |      | g1v   | 4.46  | 684   |
| -2.6 | -22.8 | 42.9  | 26 Draconis B  |      | m0v   | 7.19  | 684   |
| -2.6 | -23   | 42.8  | AC+61 26806    |      | m1v   | 9.08  | 685   |
| -2.6 | -24.2 | 8.1   | DM+23 3151     |      | m1v   | 10.14 | 686   |
| -0.6 | -5.7  | 14.2  | DM+68 946 A    |      | m3v   | 10.79 | 687   |
| -0.6 | -5.7  | 14.2  | DM+68 946 B    |      | m0v   | 13    | 687   |
| -4.1 | -40   | 2.5   | DM+3 3465      |      | k3v   | 6.06  | 688   |
| -2.4 | -27.2 | -34.7 | Mu Arae        |      | g5v   | 4.9   | 691   |
| -0.8 | -10.4 | -16.2 | L 205-128      |      | m0v   | 14    | 693   |
| -1.8 | -23   | 21.7  | DM+43 2796     |      | m3v   | 10.6  | 694   |
| -1.6 | -23.3 | 12.2  | Mu Herculis A  |      | g5iv  | 3.89  | 695   |
| -1.6 | -23.3 | 12.2  | Mu Herculis B  |      | m4v   | 10.8  | 695   |
| -1.6 | -23.3 | 12.2  | Mu Herculis C  |      | m4v   | 11.26 | 695   |
| -2.3 | -42.1 | -4.5  | DM-6 4663 A    |      | m2v   | 9.5   | 696   |
| -2.3 | -42.1 | -4.5  | DM-6 4663 B    |      | m0v   | 13    | 696   |
| -0.2 | -5.9  | 0.4   | Barnard's star |      | m5v   | 13.25 | 699   |
| 0.2  | -23.6 | -1.3  | DM-3 4233      |      | m2v   | 10.08 | 701   |
| 0.2  | -16.7 | 0.7   | 70 Ophiuchi A  |      | k0v   | 5.67  | 702   |
| 0.2  | -16.7 | 0.7   | 70 Ophiuchi B  |      | m0v   | 13    | 702   |
| 0.2  | -16.7 | 0.7   | DM+2 3482      |      | k6v   | 7.45  | 702   |
| 0.9  | -43.6 | 12.4  | DM+15 3364     |      | g6vii | 8     | 703   |
| 0.9  | -27.5 | 21.7  | DM+38 3095     |      | k2v   | 6.24  | 706   |
| 1.2  | -32.4 | -30.8 | DM-43 12343    |      | k7v   | 7.71  | 707   |
| 2.6  | -46.1 | 15.4  | DM+18 3606     |      | m1v   | 8.8   | 708   |
| 2.9  | -49.3 | 1.3   | L1064 75       |      | m5vi  | 11.6  | 708.3 |
| 2.9  | -49.3 | 1.4   | L1113 55       |      | m5vi  | 11.6  | 708.3 |
| 2.1  | -33.1 | 33.7  | DM+45 2688     |      | m0v   | 9.3   | 709   |
| 3.4  | -45.2 | -1.6  | DM-1 3474      |      | m1v   | 8.7   | 710   |
| 0.7  | -7.8  | 24    | Chi Draconis A |      | f7v   | 4.13  | 713   |
| 0.7  | -7.8  | 24    | Chi Draconis B |      | m0v   | 13    | 713   |
| 2.7  | -24.4 | -39.7 | DM-58 7076     |      | k0vii | 11.1  | 714   |
| 5.6  | -45.7 | -15.8 | DM-18 4986     |      | k3v   | 6.2   | 716   |
| 4    | -28.2 | 36    | DM+51 2402 A   |      | k6v   | 7.9   | 719   |
| 4    | -28.2 | 36    | DM+51 2402 B   |      | m0v   | 13    | 719   |
| 4    | -27.5 | 28.4  | DM+45 2743     |      | m2v   | 9.4   | 720   |
| 4    | -27.5 | 28.4  | VB 9           |      | m0v   | 14.5  | 720   |
| 3.1  | -20.3 | 16.4  | Alpha Lyrae    | Vega | a0v   | 0.5   | 721   |
| 7.1  | -45.6 | -17.8 | DM-21 5081     |      | g4v   | 5     | 722   |
| 7.9  | -48   | -9.1  | Wolf 1466      |      | m0v   | 10.5  | 723   |
| 1    | -5.8  | 9.9   | DM+59 1915A    |      | m4v   | 11.15 | 725   |
| 1    | -5.8  | 9.9   | DM+59 1915B    |      | m5v   | 11.94 | 725   |
| 1.7  | -8.5  | -3.9  | AC-24 2833-1   |      | m4v   | 13.3  | 729   |
| 10.1 | -48.3 | 2.6   | AC+3 2528-176  |      | m2v   | 9.83  | 730   |
| 8.4  | -38.7 | 11.7  | AC+16 247-80   |      | m2v   | 9.59  | 731   |
| 7.3  | -33.2 | -27.2 | L489 58 A      |      | g0vi  | 11.4  | 732   |
| 7.3  | -33.2 | -27.2 | L489 58 B      |      | m0v   | 15    | 732   |
| 5.6  | -25.3 | 34.2  | DM+52 2294     |      | g8v   | 13    | 732.1 |
| 7.9  | -33.8 | 5     | AC+8 142 393   |      | m2v   | 9.9   | 735   |
| 6.2  | -25.4 | -29.4 | DM-48 12818    |      | m4vi  | 10.6  | 739   |
| 9.1  | -37.1 | 3.9   | DM+5 3993      |      | m2v   | 8.87  | 740   |
| 11.6 | -43.1 | -10.9 | L850 62        |      | m5v   | 13.9  | 741   |
| 3.4  | -12.8 | 37.4  | AC+70 8247     |      | a0vii | 12.75 | 742   |

|      |       |       |                 |                 |       |       |       |
|------|-------|-------|-----------------|-----------------|-------|-------|-------|
| 10.6 | -37.7 | 18.9  | DM+25 3719      |                 | k2v   | 6.6   | 743.2 |
| 7.1  | -24.6 | 9.7   | AC+20 1463-148  |                 | m2vi  | 11.15 | 745   |
| 7.1  | -24.6 | 9.7   | AC+20 1463-154  |                 | m2vi  | 11.14 | 745   |
| 6.3  | -21.7 | 14.3  | AC+32 54804 A   |                 | m5v   | 12.2  | 747   |
| 6.3  | -21.7 | 14.3  | AC+32 54804 B   |                 | m5v   | 12.5  | 747   |
| 9.9  | -31.7 | 1.6   | AC+2 2155-242   |                 | m4v   | 11.13 | 748   |
| 10.1 | -30.8 | -33.5 | DM-46 12902 A   |                 | k9v   | 9.3   | 750   |
| 10.1 | -30.8 | -33.5 | DM-46 12902 B   |                 | m0vi  | 9.3   | 750   |
| 5.9  | -17.8 | 1.6   | DM+4 4048       |                 | m3v   | 10.31 | 752   |
| 5.9  | -17.8 | 1.6   | VB 10           |                 | m5v   | 19.3  | 752   |
| 4.3  | -12.3 | -13.4 | L347 14         |                 | m7v   | 14.9  | 754   |
| 10.3 | -29.3 | -4.3  | AC-7 342-402    |                 | a0vii | 12.44 | 754.1 |
| 10.3 | -29.3 | -4.3  | AC-7 342-397    |                 | m5v   | 12.93 | 754.1 |
| 13.5 | -37.6 | 10.3  | BPM 94172       |                 | a0vii | 12.5  | 755.1 |
| 15.5 | -42.2 | 5.8   | DM+7 4052       |                 | k5v   | 7.4   | 756.2 |
| 16.4 | -43.5 | 2.4   | Delta Aquilae A |                 | f0iv  | 2.6   | 760   |
| 16.4 | -43.5 | 2.4   | Delta Aquilae B |                 | m0v   | 13    | 760   |
| 16.3 | -38.4 | 3.2   | DM+4 4157       |                 | m1v   | 8.82  | 763   |
| 2.5  | -6    | 17.3  | Sigma Draconis  | Alrakis, Alsafi | k0v   | 5.92  | 764   |
| 12.5 | -25.9 | 14.6  | Ross 165 A      |                 | m4v   | 12.6  | 766   |
| 12.5 | -25.9 | 14.6  | Ross 165 B      |                 | m0v   | 13.6  | 766   |
| 15.8 | -32.3 | 22.3  | DM+31 3767A     |                 | m1v   | 9.72  | 767   |
| 15.8 | -32.3 | 22.3  | DM+31 3767B     |                 | m2v   | 10.7  | 767   |
| 7.4  | -14.5 | 2.4   | Alpha Aquilae   | Altair          | a7v   | 2.24  | 768   |
| 19   | -36.1 | -18.3 | DM-24 15668     |                 | k5v   | 5.5   | 770   |
| 21.8 | -40.8 | 5     | Beta Aquilae A  | Alshain         | g8iv  | 3.5   | 771   |
| 21.8 | -40.8 | 5     | Beta Aquilae B  |                 | m3v   | 10.6  | 771   |
| 16.8 | -31.2 | -0.8  | L997 21         |                 | a0vii | 13.51 | 772   |
| 17.4 | -30.8 | -15   | DM-23 15935     |                 | g7v   | 5.6   | 773.5 |
| 8.8  | -15.5 | -39.7 | L115 21 A       |                 | m0v   | 12.5  | 774   |
| 8.8  | -15.5 | -39.7 | L115 21 B       |                 | m0v   | 13.8  | 774   |
| 21.4 | -37.1 | 2.3   | DM+2 4076       |                 | k4v   | 6.9   | 775   |
| 3.8  | -6.5  | -17.1 | Delta Pavonis   |                 | g8v   | 4.76  | 780   |
| 7.8  | -12.8 | -10.9 | DM-36 13940 A   |                 | k3v   | 6.56  | 783   |
| 7.8  | -12.8 | -10.9 | DM-36 13940 B   |                 | m5v   | 12.7  | 783   |
| 7.5  | -11.8 | -14.2 | DM-45 13677     |                 | m0v   | 9.04  | 784   |
| 24.2 | -37.6 | 10.5  | AC+13 1185-145  |                 | m2v   | 11.8  | 784.1 |
| 13.1 | -20.3 | -12.5 | DM-27 14659 A   |                 | k1v   | 6.13  | 785   |
| 13.1 | -20.3 | -12.3 | DM-27 14659 B   |                 | m0v   | 13    | 785   |
| 5.2  | -8.1  | 41.8  | DM+76 785       |                 | m0v   | 8.3   | 786   |
| 10.8 | -16   | 44.6  | DM+66 1281      |                 | g5v   | 5.07  | 788   |
| 21.5 | -29.5 | -19.4 | DM-28 16676     |                 | m3v   | 11.1  | 791   |
| 18.1 | -24.3 | 5     | G 24-16         |                 | m6v   | 13.2  | 791.2 |
| 23.5 | -30.8 | 30.6  | Ross 188        |                 | m6v   | 14.4  | 792   |
| 6.5  | -8.6  | 23.3  | AC+65 6955 B    |                 | m3v   | 10.95 | 793   |
| 6.5  | -8.6  | 23.3  | AC+65 6955 A    |                 | m0v   | 13    | 793   |
| 24.9 | -31.9 | 18.7  | AC+24 747-102   |                 | a0vii | 10.85 | 794   |
| 26.9 | -33   | -19   | DM-24 16193     |                 | g8v   | 5.6   | 796   |
| 14.9 | -18.1 | -31   | DM-53 8617      |                 | k7v   | 8.45  | 798   |
| 15.5 | -18.7 | -15.6 | DM-32 16135 A   |                 | m4v   | 11.09 | 799   |
| 15.5 | -18.7 | -15.6 | DM-32 16135 B   |                 | m4v   | 11.2  | 799   |
| 19.6 | -23.5 | -11.3 | AC+20 76187     |                 | a0vii | 12    | 799.1 |
| 29.5 | -35.3 | -16   | DM-19 5899 A    |                 | m2v   | 9.5   | 800   |

|      |       |       |                |       |       |       |
|------|-------|-------|----------------|-------|-------|-------|
| 29.5 | -35.3 | -16   | DM-19 5899 B   | m0v   | 13.1  | 800   |
| 16.5 | -19.5 | 36.6  | Wolf 1084      | m5v   | 14.4  | 802   |
| 15.9 | -18.7 | -15.1 | DM-31 17815    | m0v   | 8.87  | 803   |
| 22.3 | -26   | -16.3 | Psi Capricorni | f4v   | 3.7   | 805   |
| 17.9 | -20.8 | 26.7  | AC+44 871-589  | m3v   | 10.5  | 806   |
| 14.1 | -16.3 | 39.8  | Eta Cephei     | k0iv  | 2.72  | 807   |
| 7.6  | -8.2  | 21    | DM+61 2068     | m2v   | 9.18  | 809   |
| 27   | -28.8 | -10.1 | L856 54 A      | m5v   | 14    | 810   |
| 27   | -28.8 | -10.1 | L856 54 B      | m0v   | 15.2  | 810   |
| 33.8 | -35.7 | -4.4  | Ross 193       | m4v   | 11    | 812   |
| 33.8 | -35.7 | -4.4  | VB 11          | m0v   | 15.8  | 812   |
| 26.7 | -28.8 | 15.7  | AC+22 308-605  | m2vi  | 11.4  | 813   |
| 25.4 | -25.9 | 30.2  | AC+39 57322 A  | m3v   | 10.7  | 815   |
| 25.4 | -25.9 | 30.2  | AC+39 57322 B  | m3v   | 11.4  | 815   |
| 25.4 | -25.9 | 30.2  | AC+39 57322 C  | m0v   | 12.3  | 815   |
| 27.8 | -28.1 | -4.6  | Wolf 906       | m3vi  | 10.6  | 816   |
| 34.5 | -33.3 | -12.1 | DM-14 5936 A   | k1v   | 6.25  | 819   |
| 34.5 | -33.3 | -12.1 | DM-14 5936 B   | m0vi  | 9.3   | 819   |
| 6.2  | -6    | 6.8   | 61 Cygni A     | k5v   | 7.58  | 820   |
| 6.2  | -6    | 6.8   | 61 Cygni B     | m0v   | 13    | 820   |
| 6.2  | -6    | 6.9   | 61 Cygni C     | k7v   | 8.39  | 820   |
| 4.1  | -4    | -40.9 | L24 52         | a0vii | 13    | 820.1 |
| 24.7 | -23.5 | -8.2  | Wolf 918       | m3vi  | 10.5  | 821   |
| 17   | -15.1 | 43.8  | DM+62 1916     | g5vii | 8.1   | 823   |
| 7.2  | -6.5  | 7.8   | DM-39 14192    | m0v   | 8.75  | 825   |
| 8.9  | -7.4  | -25.6 | Gamma Pavonis  | f8v   | 4.53  | 827   |
| 15.9 | -12.6 | 6.3   | AC+17 534-105  | m4v   | 11.27 | 829   |
| 18.9 | -14.7 | -4.3  | Wolf 922       | m4v   | 12.59 | 831   |
| 7.8  | -6.1  | -11.6 | DM-49 13515    | m1v   | 10.32 | 832   |
| 23.4 | -17.5 | -36.3 | DM-51 12998    | k2v   | 6.4   | 833   |
| 26.4 | -19.5 | 26.7  | AC+39 60670 B  | m0v   | 9.6   | 834   |
| 26.4 | -19.5 | 26.7  | AC+39 60670 A  | m0v   | 11.6  | 834   |
| 32.9 | -24   | 21.1  | DM+27 4120 A   | m0v   | 9.11  | 835   |
| 32.9 | -24   | 21.1  | DM+27 4120 B   | m0v   | 13    | 835   |
| 32   | -23.3 | -18   | L714 88        | m5v   | 14    | 836   |
| 25   | -16.8 | -33   | DM-47 13928    | g2v   | 4.9   | 838   |
| 21   | -13.3 | -26.9 | L355 62        | m0v   | 11.9  | 838.6 |
| 25.1 | -15.5 | -36.9 | DM-51 13128    | m0vi  | 9.6   | 841   |
| 25.2 | -15.5 | -36.9 | L283 7         | a0v   | 11.7  | 841   |
| 19.6 | -12.1 | 8.8   | DM+20 5046     | k5v   | 13    | 841.1 |
| 17.6 | -10.7 | -35.8 | DM-60 7821     | k0vii | 10.9  | 842   |
| 35.2 | -21.2 | -3.4  | DM-5 5674      | k2v   | 13    | 842.1 |
| 33.5 | -19.6 | -14   | L715 89        | m0v   | 12.8  | 843   |
| 31.8 | -18.5 | 10.7  | AC+16 734-144  | m2v   | 10.3  | 844   |
| 5.2  | -3.1  | -9.4  | Epsilon Indi   | k5v   | 7     | 845   |
| 27.6 | -16.1 | 0.6   | DM+0 4810      | k8v   | 9.2   | 846   |
| 34.4 | -19   | 18.4  | Iota Pegasi A  | f5v   | 3.14  | 848   |
| 34.4 | -19   | 18.4  | Iota Pegasi B  | m0v   | 13    | 848   |
| 25.5 | -13.8 | -2.5  | DM-5 5715      | m3v   | 10.67 | 849   |
| 36   | -19   | 13.3  | AC+17 536-125  | m2v   | 9.5   | 851   |
| 28   | -13.9 | -5    | Wolf 1561 A    | m4v   | 13.6  | 852   |
| 28   | -13.9 | -5    | Wolf 1561 B    | m5v   | 14.6  | 852   |
| 21   | -10.4 | -32.2 | DM-54 9222 A   | g1v   | 4.9   | 853   |

|      |       |       |                          |            |       |       |       |
|------|-------|-------|--------------------------|------------|-------|-------|-------|
| 21   | -10.4 | -32.2 | DM-54 9222 B             |            | m0vi  | 9.6   | 853   |
| 22.7 | -10.5 | -40.1 | DM-58 8327               |            | g4v   | 4.5   | 857   |
| 6.3  | -2.8  | 10.8  | Kruger 60A               |            | m3v   | 11.87 | 860   |
| 6.3  | -2.8  | 10.8  | Kruger 60B               |            | m4v   | 13.3  | 860   |
| 33.5 | -14.6 | -21.4 | DM-30 19175              |            | k5v   | 7.1   | 862   |
| 45.2 | -18   | -1    | DM-1 4323                |            | m1v   | 9.15  | 864   |
| 14.4 | -5.7  | -34.2 | L119 21                  |            | k0vii | 12.7  | 865   |
| 9.5  | -3.7  | -2.9  | L789 6                   |            | m7v   | 14.6  | 866   |
| 23.6 | -9.1  | -9.7  | DM-21 6267 A             |            | m2v   | 9.5   | 867   |
| 23.6 | -9.1  | -9.7  | DM-21 6267 B             |            | m0v   | 13    | 867   |
| 23.6 | -9.1  | -9.7  | L717 22                  |            | m4v   | 11.8  | 867   |
| 36.2 | -13.6 | -22.3 | DM-30 19255              |            | k5v   | 7.2   | 868   |
| 10.3 | -3.6  | 10.5  | DM+43 4305 A             |            | m4v   | 11.65 | 873   |
| 10.3 | -3.6  | 10.5  | DM+43 4305 B             |            | m0v   | 13    | 873   |
| 14.4 | -4.6  | -4    | DM-15 6290               |            | m5v   | 11.77 | 876   |
| 6.3  | -2    | -25.9 | L49 19                   |            | k0vii | 12.1  | 877   |
| 21.1 | -6.5  | 39.4  | Ross 226                 |            | m4v   | 13.5  | 878   |
| 20.7 | -6.2  | -13.5 | DM-32 17321              |            | k5v   | 7.03  | 879   |
| 20.5 | -6.1  | 6.2   | DM+15 4733 A             |            | m2v   | 9.5   | 880   |
| 20.5 | -6.1  | 6.2   | DM+15 4733 B             |            | m0v   | 6.2   | 880   |
| 18.2 | -5.4  | -10.9 | Alpha Piscis<br>Austrini | Formalhaut | a3v   | 2.03  | 881   |
| 40.1 | -11.8 | 15.6  | DM+19 5036               |            | g4v   | 4.82  | 882   |
| 22.2 | -6.3  | -9.8  | DM-23 17699              |            | m1v   | 8.46  | 884   |
| 8.9  | -2.3  | -6.8  | Lacaille 9352            |            | m2v   | 9.59  | 887   |
| 41.2 | -9.7  | -20.9 | DM-26 16501              |            | k0vii | 11.6  | 891   |
| 11.8 | -2.6  | 18.5  | DM+56 2966               |            | k3v   | 6.41  | 892   |
| 41.6 | -8.9  | -5.1  | L935 50                  |            | a0v   | 14.9  | 893.1 |
| 20.2 | -3.4  | 32.3  | DM+57 2735               |            | m2v   | 9.7   | 895   |
| 42.2 | -6.3  | 3.7   | G 29-38                  |            | a0vii | 12.5  | 895.2 |
| 19.6 | -2.7  | 7     | DM+19 5116 A             |            | m4v   | 11.33 | 896   |
| 10.6 | -2.7  | 7     | DM+19 5116 B             |            | m6v   | 13.4  | 896   |
| 40.1 | -5.3  | -12.4 | DM-17 6768               |            | m5vi  | 10.4  | 897   |
| 40.1 | -5.3  | -12.4 | DM-17 6768 B             |            | m0v   | 10.8  | 897   |
| 40.1 | -5.3  | -12.5 | DM-17 6769               |            | k5v   | 8     | 898   |
| 40.4 | -5.1  | 0     | Wolf 1039                |            | m4vi  | 10.6  | 899   |
| 10.4 | -1.1  | -34.3 | DM-73 1672               |            | k3v   | 6.9   | 902   |
| 45.4 | -4.6  | 4.2   | Iota Piscium             |            | f7v   | 3.39  | 904   |
| 7.3  | -0.7  | 7.1   | Ross 248                 |            | m6v   | 14.8  | 905   |
| 39.7 | -3.3  | 25.2  | AC+32 86422              |            | m5v   | 10.9  | 905.2 |
| 39.8 | -3.3  | 25.2  | AC+32 86401 B            |            | a0vii | 12.1  | 905.2 |
| 27.8 | -1.8  | 31.8  | Ross 249                 |            | m1v   | 11.5  | 907   |
| 18.5 | -1.1  | 0.6   | DM+1 4774                |            | m2v   | 10.19 | 908   |
| 8.9  | -0.4  | 33.8  | DM+74 1047 A             |            | k3v   | 6.25  | 909   |
| 8.9  | -0.4  | 33.8  | DM+74 1047 B             |            | m0v   | 13    | 909   |
| 8.9  | -0.4  | 33.8  | DM+74 1047 C             |            | m2v   | 11.5  | 909   |
| 45.7 | -1.6  | -18.6 | DM-22 6219               |            | m0v   | 9.7   | 911   |
| 34.6 | -0.1  | 17.5  | 85 Pegasi                |            | g3v   | 5.38  | 914   |
| 34.6 | -0.1  | 17.5  | 85 Pegasi                |            | g3v   | 5.38  | 914   |
| 34.6 | -0.1  | 17.5  | DM+26 4734 B             |            | m5v   | 10.6  | 914   |
| 34.6 | -0.1  | 17.5  | DM+26 4734 C             |            | m3v   | 10.6  | 914   |
| 19.4 | -0.1  | -18.4 | L362 81                  |            | a0vii | 13.48 | 915   |

# STUTTERWARP EFFICIENCY TABLE

| Drive Rating | 100   | 150  | 200  | 250  | 300  | 350  | 400  | 450  | 500  | 550  | 600  | 650  | 700  | 750  | 800  | 850  | 900  |
|--------------|-------|------|------|------|------|------|------|------|------|------|------|------|------|------|------|------|------|
| A            | 1.27  | 1.11 | 1.01 | 0.94 | 0.88 | 0.84 | 0.80 | 0.77 | 0.74 | 0.72 | 0.70 | 0.68 | 0.67 | 0.65 | 0.64 | 0.62 | 0.61 |
| B            | 1.35  | 1.18 | 1.07 | 1.00 | 0.94 | 0.89 | 0.85 | 0.82 | 0.79 | 0.77 | 0.74 | 0.72 | 0.71 | 0.69 | 0.68 | 0.66 | 0.65 |
| C            | 1.42  | 1.24 | 1.13 | 1.05 | 0.99 | 0.94 | 0.90 | 0.86 | 0.83 | 0.81 | 0.78 | 0.76 | 0.74 | 0.73 | 0.71 | 0.70 | 0.68 |
| D            | 1.49  | 1.30 | 1.18 | 1.10 | 1.03 | 0.98 | 0.94 | 0.90 | 0.87 | 0.84 | 0.82 | 0.80 | 0.78 | 0.76 | 0.74 | 0.73 | 0.72 |
| E            | 1.55  | 1.35 | 1.23 | 1.14 | 1.07 | 1.02 | 0.98 | 0.94 | 0.91 | 0.88 | 0.85 | 0.83 | 0.81 | 0.79 | 0.77 | 0.76 | 0.74 |
| F            | 1.60  | 1.40 | 1.27 | 1.18 | 1.11 | 1.06 | 1.01 | 0.97 | 0.94 | 0.91 | 0.88 | 0.86 | 0.84 | 0.82 | 0.80 | 0.79 | 0.77 |
| G            | 2.02  | 1.76 | 1.60 | 1.49 | 1.40 | 1.33 | 1.27 | 1.22 | 1.18 | 1.14 | 1.11 | 1.08 | 1.06 | 1.03 | 1.01 | 0.99 | 0.97 |
| H            | 2.31  | 2.02 | 1.84 | 1.70 | 1.60 | 1.52 | 1.46 | 1.40 | 1.35 | 1.31 | 1.27 | 1.24 | 1.21 | 1.18 | 1.16 | 1.13 | 1.11 |
| J            | 2.54  | 2.22 | 2.02 | 1.88 | 1.76 | 1.68 | 1.60 | 1.54 | 1.49 | 1.44 | 1.40 | 1.36 | 1.33 | 1.30 | 1.27 | 1.25 | 1.22 |
| K            | 2.74  | 2.39 | 2.18 | 2.02 | 1.90 | 1.81 | 1.73 | 1.66 | 1.60 | 1.55 | 1.51 | 1.47 | 1.43 | 1.40 | 1.37 | 1.34 | 1.32 |
| L            | 3.45  | 3.02 | 2.74 | 2.54 | 2.39 | 2.27 | 2.18 | 2.09 | 2.02 | 1.96 | 1.90 | 1.85 | 1.81 | 1.76 | 1.73 | 1.69 | 1.66 |
| M            | 3.95  | 3.45 | 3.14 | 2.91 | 2.74 | 2.60 | 2.49 | 2.39 | 2.31 | 2.24 | 2.18 | 2.12 | 2.07 | 2.02 | 1.98 | 1.94 | 1.90 |
| N            | 4.35  | 3.80 | 3.45 | 3.21 | 3.02 | 2.87 | 2.74 | 2.64 | 2.54 | 2.47 | 2.39 | 2.33 | 2.27 | 2.22 | 2.18 | 2.13 | 2.09 |
| P            | 4.69  | 4.10 | 3.72 | 3.45 | 3.25 | 3.09 | 2.95 | 2.84 | 2.74 | 2.66 | 2.58 | 2.51 | 2.45 | 2.39 | 2.34 | 2.30 | 2.25 |
| Q            | 5.91  | 5.16 | 4.69 | 4.35 | 4.10 | 3.89 | 3.72 | 3.58 | 3.45 | 3.35 | 3.25 | 3.16 | 3.09 | 3.02 | 2.95 | 2.89 | 2.84 |
| R            | 6.76  | 5.91 | 5.37 | 4.98 | 4.69 | 4.45 | 4.26 | 4.10 | 3.95 | 3.83 | 3.72 | 3.62 | 3.53 | 3.45 | 3.38 | 3.31 | 3.25 |
| S            | 7.44  | 6.50 | 5.91 | 5.48 | 5.16 | 4.90 | 4.69 | 4.51 | 4.35 | 4.22 | 4.10 | 3.99 | 3.89 | 3.80 | 3.72 | 3.65 | 3.58 |
| T            | 7.91  | 6.91 | 6.28 | 5.83 | 5.48 | 5.21 | 4.98 | 4.79 | 4.62 | 4.48 | 4.35 | 4.24 | 4.13 | 4.04 | 3.95 | 3.87 | 3.80 |
| U            | 8.32  | 7.27 | 6.61 | 6.13 | 5.77 | 5.48 | 5.24 | 5.04 | 4.87 | 4.72 | 4.58 | 4.46 | 4.35 | 4.25 | 4.16 | 4.08 | 4.00 |
| V            | 8.70  | 7.60 | 6.91 | 6.41 | 6.03 | 5.73 | 5.48 | 5.27 | 5.09 | 4.93 | 4.79 | 4.66 | 4.55 | 4.45 | 4.35 | 4.26 | 4.18 |
| W            | 9.05  | 7.91 | 7.18 | 6.67 | 6.28 | 5.96 | 5.70 | 5.48 | 5.29 | 5.13 | 4.98 | 4.85 | 4.73 | 4.62 | 4.53 | 4.44 | 4.35 |
| X            | 9.38  | 8.19 | 7.44 | 6.91 | 6.50 | 6.17 | 5.91 | 5.68 | 5.48 | 5.31 | 5.16 | 5.02 | 4.90 | 4.79 | 4.69 | 4.59 | 4.51 |
| Y            | 10.10 | 8.82 | 8.02 | 7.44 | 7.00 | 6.65 | 6.36 | 6.12 | 5.91 | 5.72 | 5.56 | 5.41 | 5.28 | 5.16 | 5.05 | 4.95 | 4.86 |
| Z            | 10.73 | 9.38 | 8.52 | 7.91 | 7.44 | 7.07 | 6.76 | 6.50 | 6.28 | 6.08 | 5.91 | 5.75 | 5.61 | 5.48 | 5.37 | 5.26 | 5.16 |

| Drive Rating | 950  | 1000 | 1100 | 1200 | 1300 | 1400 | 1500 | 2000 | 2500 | 3000 | 3500 | 4000 | 4500 | 5000 | 7500 | 10000 |
|--------------|------|------|------|------|------|------|------|------|------|------|------|------|------|------|------|-------|
| A            | 0.60 | 0.59 | 0.57 | 0.56 | 0.54 | 0.53 | 0.52 | 0.47 | 0.44 | 0.41 | 0.39 | 0.37 | 0.36 | 0.35 | 0.30 | 0.27  |
| B            | 0.64 | 0.63 | 0.61 | 0.59 | 0.58 | 0.56 | 0.55 | 0.50 | 0.46 | 0.44 | 0.41 | 0.40 | 0.38 | 0.37 | 0.32 | 0.29  |
| C            | 0.67 | 0.66 | 0.64 | 0.62 | 0.61 | 0.59 | 0.58 | 0.52 | 0.49 | 0.46 | 0.44 | 0.42 | 0.40 | 0.39 | 0.34 | 0.31  |
| D            | 0.70 | 0.69 | 0.67 | 0.65 | 0.63 | 0.62 | 0.60 | 0.55 | 0.51 | 0.48 | 0.46 | 0.44 | 0.42 | 0.40 | 0.35 | 0.32  |
| E            | 0.73 | 0.72 | 0.70 | 0.68 | 0.66 | 0.64 | 0.63 | 0.57 | 0.53 | 0.50 | 0.47 | 0.45 | 0.44 | 0.42 | 0.37 | 0.33  |
| F            | 0.76 | 0.74 | 0.72 | 0.70 | 0.68 | 0.67 | 0.65 | 0.59 | 0.55 | 0.52 | 0.49 | 0.47 | 0.45 | 0.44 | 0.38 | 0.35  |
| G            | 0.95 | 0.94 | 0.91 | 0.88 | 0.86 | 0.84 | 0.82 | 0.74 | 0.69 | 0.65 | 0.62 | 0.59 | 0.57 | 0.55 | 0.48 | 0.44  |
| H            | 1.09 | 1.07 | 1.04 | 1.01 | 0.98 | 0.96 | 0.94 | 0.85 | 0.79 | 0.74 | 0.71 | 0.68 | 0.65 | 0.63 | 0.55 | 0.50  |
| J            | 1.20 | 1.18 | 1.14 | 1.11 | 1.08 | 1.06 | 1.03 | 0.94 | 0.87 | 0.82 | 0.78 | 0.74 | 0.72 | 0.69 | 0.60 | 0.55  |
| K            | 1.29 | 1.27 | 1.23 | 1.20 | 1.17 | 1.14 | 1.11 | 1.01 | 0.94 | 0.88 | 0.84 | 0.80 | 0.77 | 0.74 | 0.65 | 0.59  |
| L            | 1.63 | 1.60 | 1.55 | 1.51 | 1.47 | 1.43 | 1.40 | 1.27 | 1.18 | 1.11 | 1.06 | 1.01 | 0.97 | 0.94 | 0.82 | 0.74  |
| M            | 1.87 | 1.84 | 1.78 | 1.73 | 1.68 | 1.64 | 1.60 | 1.46 | 1.35 | 1.27 | 1.21 | 1.16 | 1.11 | 1.07 | 0.94 | 0.85  |
| N            | 2.05 | 2.02 | 1.96 | 1.90 | 1.85 | 1.81 | 1.76 | 1.60 | 1.49 | 1.40 | 1.33 | 1.27 | 1.22 | 1.18 | 1.03 | 0.94  |
| P            | 2.21 | 2.18 | 2.11 | 2.05 | 1.99 | 1.95 | 1.90 | 1.73 | 1.60 | 1.51 | 1.43 | 1.37 | 1.32 | 1.27 | 1.11 | 1.01  |
| Q            | 2.79 | 2.74 | 2.66 | 2.58 | 2.51 | 2.45 | 2.39 | 2.18 | 2.02 | 1.90 | 1.81 | 1.73 | 1.66 | 1.60 | 1.40 | 1.27  |
| R            | 3.19 | 3.14 | 3.04 | 2.95 | 2.88 | 2.81 | 2.74 | 2.49 | 2.31 | 2.18 | 2.07 | 1.98 | 1.90 | 1.84 | 1.60 | 1.46  |
| S            | 3.51 | 3.45 | 3.35 | 3.25 | 3.16 | 3.09 | 3.02 | 2.74 | 2.54 | 2.39 | 2.27 | 2.18 | 2.09 | 2.02 | 1.76 | 1.60  |
| T            | 3.73 | 3.67 | 3.56 | 3.45 | 3.36 | 3.28 | 3.21 | 2.91 | 2.70 | 2.54 | 2.42 | 2.31 | 2.22 | 2.15 | 1.88 | 1.70  |
| U            | 3.93 | 3.86 | 3.74 | 3.64 | 3.54 | 3.45 | 3.38 | 3.07 | 2.85 | 2.68 | 2.54 | 2.43 | 2.34 | 2.26 | 1.97 | 1.79  |
| V            | 4.11 | 4.04 | 3.91 | 3.80 | 3.70 | 3.61 | 3.53 | 3.21 | 2.98 | 2.80 | 2.66 | 2.54 | 2.45 | 2.36 | 2.06 | 1.88  |
| W            | 4.27 | 4.20 | 4.07 | 3.95 | 3.85 | 3.76 | 3.67 | 3.33 | 3.10 | 2.91 | 2.77 | 2.65 | 2.54 | 2.46 | 2.15 | 1.95  |
| X            | 4.43 | 4.35 | 4.22 | 4.10 | 3.99 | 3.89 | 3.80 | 3.45 | 3.21 | 3.02 | 2.87 | 2.74 | 2.64 | 2.54 | 2.22 | 2.02  |
| Y            | 4.77 | 4.69 | 4.54 | 4.41 | 4.30 | 4.19 | 4.10 | 3.72 | 3.45 | 3.25 | 3.09 | 2.95 | 2.84 | 2.74 | 2.39 | 2.18  |
| Z            | 5.07 | 4.98 | 4.83 | 4.69 | 4.56 | 4.45 | 4.35 | 3.95 | 3.67 | 3.45 | 3.28 | 3.14 | 3.02 | 2.91 | 2.54 | 2.31  |

TRAVELLER

# THE IMPERIAL



**MONGOOSE PUBLISHING**

[www.mongoosepublishing.com](http://www.mongoosepublishing.com)



# LEGEND



ONLY FROM MONGOOSE

[WWW.MONGOOSEPUBLISHING.COM](http://WWW.MONGOOSEPUBLISHING.COM)



# JUDGE DREDD

The Roleplaying Game

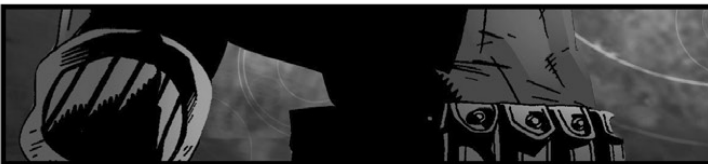
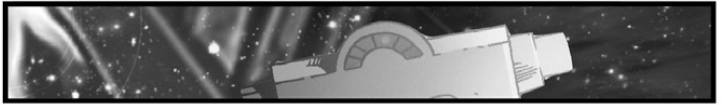

**MEGA-CITY ONE - A VAST METROPOLIS WHERE EACH OF 400 MILLION CITIZENS IS A POTENTIAL LAWBREAKER. PATROLLING THESE MEAN STREETS ARE THE JUDGES, TOUGH LAWYEN OF THE FUTURE, TRAINED TO KEEP THE PEACE AND EQUIPPED TO TAKE ON THE CRIMINALS OF THE 22ND CENTURY. TOUGHEST OF THEM ALL IS JUDGE DREDD, FOR HE IS THE LAW, AND YOU BETTER BELIEVE IT CREEP!**

**BECOME A JUDGE, PATROLLING THE STREETS OF MEGA-CITY ONE, TRACKING DOWN LAWBREAKERS AND BRINGING PERPS TO JUSTICE! ARMED WITH THE FAMOUS LAWGIVER SIDEARM, YOU HAVE THE SUPPORT OF THE ENTIRE JUSTICE DEPARTMENT AS YOU RACE DOWN THE MEGWAYS AT 200MPH ON THE BACK OF YOUR LAWMASTER, TAKING THE LAW TO THE STREETS.**

## ONLY FROM MONGOOSE PUBLISHING

[WWW.MONGOOSEPUBLISHING.COM](http://WWW.MONGOOSEPUBLISHING.COM)

# TRAVELLER

REQUIRES THE TRAVELLER MAIN RULEBOOK



# 2300AD

*2300AD* games range from interstellar exploration and interstellar war, down to the gritty streets and the mega-cities of the human core. This is a game about people, and their rise to the stars. Aliens are a part of the *2300AD* milieu, but the focus of the game is on humans.

*2300AD* strives to obey the laws of the universe as we know them. The stutterwarp drive, the technology that allows humanity to travel faster than light, is the sole departure from this. Some of the other technologies bend the laws a little, but that's from the standpoint of the early 21st century. Three hundred years in the future is a long time. There are no blasters or laser swords in *2300AD*, no magic anti-gravity or artificial gravity – just guns and helicopters, spin habitats and spaceplanes. At the same time, though, *2300AD* is a game, not a hard-and-fast technical simulation.

The *Traveller Core Rulebook* is required to play *2300AD*.

**MONGOOSE  
PUBLISHING**

MGP 20000 US\$ 49.99

ISBN 978-1-907702-73-0

